



NRHA



NATIONAL REINING HORSE ASSOCIATION

2014 HANDBOOK

*Bylaws, Rules and Regulations
Judges' Guide*

NATIONAL REINING HORSE ASSOCIATION

MILLION DOLLAR SIRES:

YEAR:	NAME:	YEAR:	NAME:
1993	Hollywood Jac 86	2007	Grays Starlight Gunner
1995	Be Aech Enterprise	2008	Nu Chex To Cash Smart Like Juice Wimpys Little Step
1997	Hollywood Dun It	2009	Smart Starbuck
1998	Topsail Cody	2010	Magnum Chic Dream
1999	Smart Chic Olena	2011	Conquistador Whiz West Coast Whiz Rowdy Yankee
2001	Topsail Whiz	2012	Smart Spook Whizard Jac Whiz N Tag Chex Jacs Electric Spark
2002	Shining Spark	2013	Einstein
2003	Reminic		
2004	Gallo Del Cielo		
2005	Custom Crome		
2006	Lil Ruf Peppy Boomernic		

TWO MILLION DOLLAR SIRES:

2000	Hollywood Dun It	2010	Gunner Wimpys Little Step
2002	Smart Chic Olena	2012	Nu Chex To Cash Smart Like Juice
2003	Topsail Whiz	2013	Magnum Chic Dream
2005	Shining Spark		
2007	Gallo Del Cielo		
2009	Custom Crome Lil Ruf Peppy		

THREE MILLION DOLLAR SIRES:

2002	Hollywood Dun It	2010	Gallo Del Cielo
2004	Topsail Whiz	2011	Wimpys Little Step Gunner
2005	Smart Chic Olena	2012	Custom Crome
2008	Shining Spark		

FOUR MILLION DOLLAR SIRES:

2004	Hollywood Dun It	2012	Gunner
2006	Topsail Whiz	2012	Wimpys Little Step
2007	Smart Chic Olena	2013	Shining Spark

FIVE MILLION DOLLAR SIRES:

2007	Hollywood Dun It Topsail Whiz	2009	Smart Chic Olena
		2013	Wimpys Little Step Gunner

SIX MILLION DOLLAR SIRES:

2009	Topsail Whiz	2012	Smart Chic Olena
2010	Hollywood Dun It		

SEVEN MILLION DOLLAR SIRES:

2010 Topsail Whiz

EIGHT MILLION DOLLAR SIRES:

2011 Topsail Whiz

NINE MILLION DOLLAR SIRES:

2012 Topsail Whiz

NATIONAL REINING HORSE ASSOCIATION

MILLION DOLLAR RIDERS:

YEAR:	NAME:	YEAR:	NAME:
1995	Bill Horn	2007	Mandy McCutcheon
1997	Tim McQuay	2008	Brent Wright Craig L. Johnson Randy Paul
2003	Shawn Flarida Duane Latimer	2010	Todd Sommers
2004	Todd Bergen	2011	Rudi Kronsteiner Jordan Larson
2005	Dell Hendricks Craig Schmersal	2012	Rocky Dare Bernard Fonck
2006	Andrea Fappani		
2006	Tom McCutcheon		

TWO MILLION DOLLAR RIDERS:

2005	Tim McQuay	2010	Craig Schmersal Andrea Fappani
2006	Shawn Flarida		

THREE MILLION DOLLAR RIDERS:

2008	Shawn Flarida	2012	Tim McQuay
2012	Andrea Fappani		

FOUR MILLION DOLLAR RIDERS:

2011 Shawn Flarida

MILLION DOLLAR OWNERS:

2007	Lance Griffin Tim McQuay	2010	Rosanne Sternberg
2008	Arcese Quarter Horses USA	2012	Rancho Oso Rio, LLC
		2013	Smart Like Juice, Inc.

NRHA DALE WILKINSON LIFETIME ACHIEVEMENT AWARD:

2008	Sally Brown	2010	C.R. Morrison
2009	Don Burt Don Hotz	2012	Tracy Lynch



Foreword

The National Reining Horse Association is a non-profit Organization dedicated to the promotion of the Reining Horse. The Association was formed in 1966 to encourage the showing of reining horses by providing worthwhile purses for which they can compete, by developing a standard method under which all reining contests can be conducted, and by acting as a forum for their breeders and trainers.

In the fall of 1967 the Executive Committee of the National Reining Horse Association appointed its first Directors. A Rules Committee was chosen from these men. This booklet contains a revised version of the original ground rules and further changes will be adopted by the Board of Directors as deemed necessary. Deciding rule changes will not be difficult if our officers and Board of Directors remember the dedication and original intent of our founders.

© The *NRHA Handbook* is the copyrighted property of the National Reining Horse Association. No person may use and/or reproduce this *Handbook* without the express written permission of the National Reining Horse Association. Shows seeking sanctioning and receiving approval from the Association are expressly authorized to use the information contained in this *Handbook*.

FOR THE MOST CURRENT OFFICIAL VERSION OF THE HANDBOOK, VISIT OUR WEBSITE AT NRHA.COM. New rules and changes to rules are highlighted in gray.

Notes

TABLE OF CONTENTS

NRHA BYLAWS

Article I. Title, Objectives, Locations, Definitions.....	7
Article II. Membership.....	8
Article III. Membership Meeting.....	10
Article IV. Officers and Executive Committee.....	11
Article V. Election of Officers.....	11
Article VI. Duties of Officers and Executive Committee.....	12
Article VII. Board of Directors.....	13
Article VIII. Committees.....	20
Article IX. NRHA Affiliates.....	26
Article X. Parliamentary Authority.....	27
Article XI. Annual Statements.....	27
Article XII. Indemnification.....	28
Article XIII. Contracts, Loans, Checks and Deposits.....	28
Article XIV. Miscellaneous Provisions.....	28
Article XV. Amendments.....	29

ELECTION PROCEDURES.....31

GENERAL RULES AND REGULATIONS

A. Rule Change Procedures.....	39
B. Affiliate Compliance.....	39
C. International Affiliate Program.....	40
D. Disciplinary Procedures.....	41
E. Causes For Disciplinary Action.....	46
F. Causes for Disciplinary Action (Protest or complaint not required).....	46
G. Animal Welfare and Medications Provisions Applicable to all NRHA Events.....	48

SHOW RULES AND REGULATIONS

A. Membership.....	59
B. Non Pro Conditions.....	60
C. Competition Licensing.....	64
D. Categories of Competition and Class Eligibility.....	66
E. Unapproved Classes.....	73
F. Event Approval.....	74
G. Ancillary Show Conditions.....	80
H. Aged Show and Closed Aged Show Conditions.....	82
I. Breed Restricted Show Conditions.....	83
J. Jackpot Affiliate Show Conditions.....	84
K. Entry Level Ride & Slide Level 2 Show Conditions.....	85
L. Entry Level Ride & Slide Level 1 Show Conditions.....	85
M. Green Level Show Conditions.....	86
N. Adaptive Reining Show Conditions.....	86
O. Trophies.....	87
P. General Show Conditions.....	88
Q. Ties.....	90
R. Show Results.....	90
S. Year End Awards.....	92
NRHA Payback Schedules A & B.....	94
Worksheet for NRHA Paybacks.....	95

NATIONAL REINING HORSE YOUTH ASSOCIATION BYLAWS

Article I. NRHYA Youth Mission Statement.....	97
Article II. Title, Objectives, Location.....	97
Article III. NRHYA Executive Committee.....	97
Article IV. Election of Officers.....	97
Article V. Duties of Officers.....	98
Article VI. General Governance.....	99
Article VII. Membership Meeting.....	100
Article VIII. Membership and Regions.....	100
Article IX. Removal of Officers.....	100
Article X. Amendments.....	100

YOUTH SHOW RULES AND REGULATIONS	
A. Membership and Show Conditions	101
B. Approved Youth Reinings.....	101
C. Incentive Awards	103
D. Year-End Awards.....	104
NRHA Youth Point Scale.....	104
NATIONAL FEDERATION	104
NRHA SHOW STEWARDS	
A. Stewarding Privileges	105
B. Guidelines	105
C. Duties of the Show Steward	106
FREESTYLE REINING	
A. General Rules.....	111
B. Judging of Freestyle Reining.....	112
JUDGES	
A. Judging Privileges	115
B. Judges Committee.....	115
C. Guidelines	116
RULES FOR JUDGING	
A. General.....	121
B. Scoring	121
Patterns	127
NRHA JUDGES' GUIDE	
General Judging and Scoring Guidelines	155
Penalty Application	156
Pre/Post Check.....	156
No Scores	158
Penalty Score Zero.....	160
5 Point Penalties	161
2 Point Penalties	162
Lead Penalties	163
Jog Penalties	164
Simple Lead Change Penalties	164
Spin Penalties	165
Wall Penalty.....	165
Reviews	165
Maneuvers	166
Pattern Descriptions	167
A. Scoring	174
B. Maneuver Scores	175
C. Misconduct/Re-Rides	176
D. Reports/Conduct	177
FREESTYLE	
A. Score Card	181
B. Scoring/Penalties.....	182
JUDGING DIAGRAMS	
Figure 1. Bit Measurements	189
Figure 2. Bit Measurements	190
Figure 3A. Over/Under Spin Penalty Application.....	191
Figure 3B. Lead Departure Penalty Application	191
Figure 4. Out of Lead/Delayed Change Penalty Application	192
Figure 5. Jog Penalty Application	193
Figure 6. Out of Lead on Run-Around Penalty Application ..	194
Figure 7. Out of Lead on Partial Circle Leading to Run-Down Penalty Application	195
Figure 8. Sample Score card	196
Figure 9. Sample Freestyle Score card	196
NRHA ELIGIBILITY POLICY	197

Notes

NATIONAL REINING HORSE ASSOCIATION BYLAWS

ARTICLE I. TITLE, OBJECTIVES, LOCATION, DEFINITIONS

Section 1. Title. This organization is incorporated under the laws of the State of Oklahoma and shall be known as the National Reining Horse Association, and shall at all times be operated as a not for profit association in accordance with the laws of the State of Oklahoma and the United States of America.

Section 2. Objectives. To promote and encourage development of and public interest in agriculture and ranching through the promotion of public reining horse shows; the development of suitable and proper standards of performance and judging intended to govern all reining horse contests sponsored and approved by the National Reining Horse Association; to encourage the development and breeding of better Reining Horses; and to develop and disseminate informational material deemed desirable to provide contestants and spectators a better understanding of a proper performance of the reining horse in the show arena.

Section 3. Place of Business. The principal office of the Association shall be Oklahoma City, Oklahoma or as the Board of Directors shall designate.

Section 4. Upon the dissolution of the Association, the Board of Directors shall, after paying or making provision for the payment of all the liabilities of the Association, dispose of all the assets of the Association exclusively for the purposes of the Association in such manner, or to such organization or organizations organized and operated exclusively for charitable, educational, religious or scientific purposes as shall at the time qualify as an exempt organization or organizations under Section 501(c)(3) or 501(c)(5) of the Internal Revenue Code of 1986 or the corresponding provision of any future United States Internal Revenue Law, as the Board of Trustees shall determine. Any of such assets not so disposed of shall be disposed of by the Court of Common Pleas of the County exclusively for such purpose or to such organization or organizations of said court determine, which are organized or operated exclusively for such purposes.

Section 5. The following definitions are applied to the use of any title or term herein listed when used throughout the NRHA Bylaws, any NRHA Rules and Regulations, and any Policy or Procedure adopted and published as official by NRHA.

(1) **Association** A general reference to NRHA.

(2) **Board of Directors** That governing body comprised of all Officers and Directors. Also may be generally referred to as “the Board” or “Board.”

(3) **Committee Chairs** Appointed by the President to serve as the presiding member of the respective committee.

(4) **Committee Members** Selected by the Committee Chair

to serve as a voting participant to the respective committee.
(5) Director General Reference to a Director-At-Large and Regional/NAA Director.

(6) Directors-At-Large Those six (6) members elected by the entire membership to two-year terms of service. A Director-At-Large is an Officer of the association and a member of the Executive Committee and Board of Directors.

(7) Elections Administrator Independent company and/or NRHA staff member selected by the Executive Committee to administer annual elections.

(8) Executive Committee President, Vice President and six Directors-At-Large.

(9) Commissioner Individual employed by NRHA to manage the day-to-day activities and ongoing functions of NRHA as described in these Bylaws.

(10) Ex-Officio Member An individual who, by virtue of his/her office or position, has been appointed to be a member of a committee or board.

(11) Member(s) A general reference to those individuals and legal entities that have paid a membership fee to the Association and are further defined in these bylaws, rules and regulations. Unless otherwise described, wherever “member(s)” is found in the bylaws, rules and regulations, it is understood to mean NRHA member or all NRHA members.

(12) NRHA Abbreviation for the National Reining Horse Association.

(13) Officer The President, Vice President, and six Directors-At-Large are officers of the Association.

(14) President Elected initially to the office of Vice President by the membership to serve a two-year term, he/she then progresses to the office of President to serve an additional two-year term.

(15) Regional Director/NAA Director Those members elected to a two-year term by their respective Affiliate Region or NAA country.

(16) RHSF Abbreviation for the Reining Horse Sports Foundation.

(17) Vice President Elected by members for a two-year term after which he/she progresses to the position of President for a two-year term.

ARTICLE II. MEMBERSHIP

Section 1. Membership is open to any individual of good character and reputation that has an interest in reining horses and the promotion of the reining horse. However, membership is a privilege and not a vested right and is granted, rejected or revoked at the discretion of the Executive Committee.

Section 2. Members shall be admitted and retained in accordance with the rules and regulations of the National Reining Horse Association.

Section 3. Each member of the Association shall pay annual membership dues to the NRHA. Said dues are due and payable at the commencement of each calendar year. The calendar year of this Association shall be January 1, through December 31 of each year. A youth membership is also available. All membership dues and charges for the *NRHA Reiner* shall be set by the Board of Directors.

Section 4. Life Membership in the National Reining Horse Association is considered an individual membership and is also available. Dues for a life membership shall be set by the Board of Directors.

Section 5. All money paid to NRHA will be required to be in U.S. Funds.

Section 6. No exhibitor or owner may be required to be a member of any organization other than the National Reining Horse Association in order to compete in an NRHA approved reining event or class, with the exception that dual memberships may be required for NRHA/National Equestrian Federation or Federation Equestre Internationale dual approved events, breed association affiliates/alliances dual approved events and memberships in one's own local affiliate for participation in the regional/country NRHA Affiliate Championship circuit series. Although highly encouraged, membership in one's National Association Affiliate shall be strictly voluntary. Non-competitors desiring membership in the NRHA may apply directly to the NRHA Office.

Section 7. A voting Member is a Member who is nineteen (19) years of age or older as of January 1 of the calendar year, and who is a member in good standing prior to receiving notice of a general membership meeting at which association business will take place.

Section 8. Voting by the Membership.

(a) The membership of this Association shall annually and/or biannually elect the officers and directors under the procedures called for within these Bylaws and the *NRHA Handbook*. A majority of the ballots cast shall determine the outcome of officer and director elections. In the case of a tie vote, the Board of Directors shall vote to break the tie.

(b) The members of this Association may vote on such additional issues that appear on the election ballot as follows:

i. Bylaw amendments under the procedures governed by Article XV.

ii. Other Association issues as determined by the Board of Directors that may be placed on the ballot for the vote of the general membership.

(c) The casting of ballots by members shall be by electronic internet vote established with a commercial internet voting service selected by the Board of Directors. For members who

do not have computer access or elect not to use the electronic internet voting alternative, the Association shall provide that member with a mail-in paper ballot.

(d) Procedures for the electronic internet vote and the mail-in paper ballot shall be established by the Nominating Committee with approval by the Board of Directors.

(e) All voting by mail-in paper ballots shall be sent directly to an elections administrator appointed by the Executive Committee of the Association.

(f) The results of the internet voting shall be combined with the tally of the mail-in ballots and announced by the elections administrator within one (1) week after the cut-off date/time for voting.

(g) Voting by members in any NRHA election shall be limited to individual General memberships and the member must be 19 years of age or older on January 1 of the election year and be in good standing with the Association upon receiving voting credentials for the respective upcoming election. Memberships within the association recorded as Joint, Corporate, Syndicate, Associate, Alliance, Affiliate, NAA, etc., are not considered individual memberships and are not eligible to vote in any NRHA election. No individual shall vote more than one ballot in any election.

ARTICLE III. MEMBERSHIP MEETING

Section 1. The Annual General Membership Meeting of the Association shall be held on a date and at a time and place designated by the Board of Directors. Notice of the annual meeting shall be published in the *NRHA Reiner* magazine and on the Association's website at least four (4) months prior to the date of the meeting. A detailed agenda shall be published in the *NRHA Reiner* magazine and on the Association's website at least sixty (60) days prior to the date of the meeting. Members desiring to place items on the agenda or resolutions to be considered at the meeting shall submit same in writing to the Association's office at least 90 days prior to the annual scheduled meeting.

Section 2. Special meeting of the membership may be called by the Board of Directors to be held at a time and place designated by the Board of Directors. Notice for special meetings will be given in the official publication of the Association or through special mailing to each member at least thirty (30) days prior to the meeting. Business transacted at all special meetings shall be confined to the objects stated in the call and notice of the meeting and matters germane thereto.

Section 3. At any meeting of the Association, whether it is a general membership meeting or a special meeting, the members present shall constitute a quorum regardless of the number actually present.

ARTICLE IV. OFFICERS AND EXECUTIVE COMMITTEE

Section 1. The officers of the Association shall be a President, a Vice President, and six (6) Directors-At-Large. These officers shall comprise the Executive Committee of the Association. The salaries of all officers and agents of the corporation shall be fixed by the Board of Directors at the Board's sole discretion.

ARTICLE V. ELECTION OF OFFICERS

Section 1. The election of officers (generally referred to as the annual election) shall be held each year during a 30 day period of time designated by the Board of Directors at their first meeting of the year. The term of all newly elected officers of the Association shall commence on January 1 following the elections.

(a) So as to have continuity in the officers of the Association, three Directors-At-Large will be elected annually. Every other year a Vice President shall be elected and the existing Vice President will advance to the President's Chair.

(b) The President and Vice President shall serve two-year terms, respectively.

(c) A Director-At-Large shall serve a two (2) year term and shall be eligible for nomination and re-election by the general membership at the end of that term.

Section 2. Nominations of candidates for the offices open for election shall be submitted by the Nominating Committee to the Board of Directors no less than ninety (90) days prior to the start of the annual election. All candidates for officer positions must have a minimum of one (1) year previous experience on the NRHA Board of Directors prior to taking office.

Section 3. At the written request of ten (10) members of the Association, a candidate other than those submitted by the above mentioned committee may be placed into nomination and it shall be immediately given to the membership, provided said written requests for nomination is placed in the hands of the NRHA office, not less than sixty (60) days before the annual election.

Section 4. Each member of the Association, in good standing at the time of the election shall be entitled to one (1) vote. Paper ballots bearing the signature and password of the member in good standing will be accepted provided they are received by the Elections Administrator not less than five (5) days prior to the end of the election close date. There will be no proxy voting accepted by the Association.

Section 5. All voting for officers shall be by mail-in paper ballot or by electronic internet voting and the results shall be counted and reported by an Elections Administrator appointed by the Executive Committee. The term of all newly elected officers of the Association shall commence on January 1 following the elections.

Section 6. In the event of a tie in the election of officers, the Board of Directors will vote to break the tie.

ARTICLE VI. DUTIES OF OFFICERS AND EXECUTIVE COMMITTEE

Section 1. Executive Committee. The President, Vice President and the six elected Directors-At-Large are the officers of the Association and shall comprise the Executive Committee.

(a) The Executive Committee shall be charged with the daily operational responsibilities of the Association as delegated by the Board of Directors and these bylaws, specifically limited to those decisions necessary, on a daily basis or requiring immediate attention, for continuity as established by the Bylaws, Rules and Regulations, Active Resolutions adopted by the Board of Directors and Policies and Procedures approved by the Board of Directors. Any such decision or action taken by the Executive Committee as allowed herein requires a majority approval of the officers who comprise the Executive Committee.

(b) Any such actions taken under this Section shall be reported in the Executive Committee minutes and in detail at the next regularly scheduled meeting of the Board of Directors.

(c) The Board of Directors has the oversight responsibility for the Executive Committee of this association and, by a 2/3 majority, can countermand any actions or decisions the Board deems appropriate.

(d) The Officers of the Association shall not, without prior Board of Director's approval, bind the Association to any long term contractual obligations. For purposes of these Bylaws, long term contractual obligation is defined as any contractual agreement which requires expenditures of funds on behalf of the Association and shall be in effect for a period in excess of two (2) years. Furthermore, the officers shall not have the authority to bind the Association to any agreement, debt, obligation, or expenditure of Ten Thousand (\$10,000) Dollars or more, without the prior approval of the Board of Directors. No cumulative expenditures totaling Ten Thousand (\$10,000) Dollars or more is permitted to any one (1) person, partnership, corporation, or out of the same transaction during the current fiscal year without prior Board of Directors approval.

Section 2. Duties of the President

(a) The President shall be the Executive Officer of the Association. He/She shall preside at all meetings of the Board of Directors and membership meetings. Within any limitations imposed by the Articles of Incorporation, these Bylaws, or the Board of Directors, he/she shall have general power to conduct and manage the affairs and business of the Association and shall see that all orders and resolutions of the Board are carried into effect; subject, however, to the right of the Directors to delegate any specific powers, except

such as may be by statute exclusively conferred upon the President, to any other officer or officers of the Association. He/She shall be ex-officio a member of all committees, with the exception of the Nominating Committee.

(b) The President does not set policy or obligate the organization or its resources independent of the Board of Directors.

(c) He shall execute bonds, mortgages, contracts and other documents approved by the Board of Directors requiring execution on behalf of the Association.

(d) The President shall oversee the activity of the Executive Committee, Standing Committees (with the exception of the Nominating Committee) and other Board created committees. Such oversight shall be strictly limited to assuring that they are functioning in accordance with the policies and vision set forth by the Board of Directors.

Section 3. It shall be the duty of the Vice-President to perform all of the duties of the President, in the event of his/her absence or incapacity to serve. In the Event that both the President and the Vice President are absent or unable to serve, the Board of Directors shall appoint an Executive Committee member to serve in that capacity until either officer has returned to service.

Section 4. Whenever they deem necessary, the officers of the Association may, by a majority vote, call a meeting of the Executive Committee.

Section 5. Removal. Any Executive Committee Member may be removed by a majority vote of the Board of Directors whenever in its judgment, the best interests of the Association would be served thereby. However, such removal shall be without prejudice to the contract rights, if any, of the person so removed.

Section 6. Vacancies. If the office of any officer, or agent, one or more, becomes vacant for any reason, the Board of Directors may choose a successor or successors, who shall hold office for the unexpired time in respect of which such vacancy occurred.

ARTICLE VII. BOARD OF DIRECTORS

Section 1. The business of this Association shall be managed by its Board of Directors. The Board of Directors shall be comprised of the Executive Committee and a number of elected Directors including: Regional Directors as defined in Section 1(a). and National Association Affiliate Directors (NAA Directors) as defined in section 1(c).

(a) Regional Directors. The NRHA Board of Directors shall be empowered to create, delete or modify regions which shall encompass specified geographic areas on any Continent with an NRHA membership, the boundaries of which may change from time to time as determined by the Board of Directors of the Association. NRHA members from each Af-

affiliate Region which has achieved an NRHA membership of 500 shall elect at least one director to the NRHA Board of Directors. An additional director shall be elected from the Affiliate Region when total NRHA membership in the region reaches 1,000 members and another seat shall be elected for each additional 500 members. In order to maintain parity at the one (1) director for each 500 members ratio, total directors to be elected within each U.S. Region will be based on membership numbers as of December 31st of the prior year. Then a determination will be made of the additional directors to be elected based on the total U.S. NRHA membership. Regions with the greatest number of excess members over their 1/500 ratio will be allowed to elect one additional director until the 1/500 ratio is achieved in total for the U.S. Commencing with the 2012 Election year, regional director terms shall be staggered based on a formula determined by the Board of Directors and published within Section A. Election Procedures, General Rules and Regulations of the *NRHA Handbook*. Membership numbers as of December 31 of the prior year will be used to determine current term director seats available for the Affiliate Regions. All newly elected Regional Directors shall serve a term of two years which shall commence on January 1 following the elections. Should a country with an NAA, at any time upon direction by the NRHA Board, be incorporated into an Affiliate region, continuation of the NAA designation and participation in the IAP shall be at the discretion of the NRHA Board.

(b) Elected Affiliate Regional Directors

- i. Shall be a citizen of a country that is associated with a region from which they are elected.
- ii. Shall be a resident of the Region from which they are elected.
- iii. Shall be a member in good standing of the NRHA.
- iv. Serve an initial term of two years and may be re-elected by NRHA members within their Region for additional two year terms.
- v. The nomination of candidates and election procedures of Regional Directors shall be established by the Board of Directors and published within the General Rules and Regulations of the Association Handbook.
- vi. The NRHA Board of Directors shall be empowered to fill vacancies occurring among the U.S. Regional Directors by a majority vote of the remaining U.S. Regional Directors and Officers. Vacancies occurring among Regional Directors from foreign Affiliate Regions shall be filled according to the procedures established in the General Rules, Section A of the *NRHA Handbook*. An individual elected to fill a vacancy shall, if possible, come

from the same Affiliate Region in which the vacancy occurred, shall meet the same qualifying criteria and shall serve the unexpired term of their predecessor.

(c) NAA Directors. Each National Association Affiliate (NAA) with 200 members, that is not part of any region shall have the right to one seat (NAA Director) on the NRHA Board provided at least four (4) NRHA approved shows with a full slate of classes were held in that country during the previous calendar year. One additional director seat will be available when that NAA reaches 1,000 members and another seat for each additional 500 members. Membership numbers as of December 31 of the prior year will be used to determine current year director seats available to the NAA country. The term of all newly elected NAA directors shall be two years commencing January 1 following the elections. In the event there is a change in NAA status, the elected Directors will serve the remainder of the term for which they were elected.

(d) Elected NAA Directors

- i.** The nomination and election of the NAA director(s) shall be administered by the respective NAA under the procedures approved by the NRHA Board of Directors.
- ii.** NRHA members in good standing, residing in each NAA country shall be allowed to participate in the nomination and election process of the NAA Director(s) from their respective country.
- iii.** Each year the NAA must advise NRHA of the elected NAA director(s).
- iv.** Shall be a citizen of the NAA country or a country that is associated with a region from which they are elected.
- v.** Shall be a resident of the NAA country they are representing.
- vi.** Shall be a member in good standing of the NRHA.
- vii.** Shall be a member in good standing of the NAA.
- viii.** Each NAA's Board of Directors shall be empowered to fill vacancies occurring among that country's NAA Directors. An individual selected to fill a vacancy shall meet the same qualifying criteria and shall serve the unexpired term of their predecessor.

(e) Voting Members as defined in Article II. Section 8. (g) plus Youth members will be used to establish the number of Regional and NAA Directors.

(f) Voting for Regional Directors shall be accomplished by electronic internet voting where practical and applicable or by mail-in paper ballot and the results shall be counted and reported by an Elections Administrator appointed by the Executive Committee.

(g) At no time shall there be more than one (1) member of an immediate family (as defined within the General Rules

and Regulations of this Association) serving on the Board of Directors of the Association.

(h) The President of the Reining Horse Sports Foundation (RHSF) shall be ex-officio a member of the NRHA Board of Directors.

(i) In the event of a tie vote, the Board of Directors will vote to break the tie.

Section 2. The Board of Directors shall have general charge of the affairs, finances and property of the Association.

(a) The Board of Directors shall make an annual report of the general state of the affairs and finances of the Association to the membership at the Annual General Membership Meeting. A copy of this report shall be published on the Members Only page of the Association's website.

(b) In addition to the responsibilities charged to the Board of Directors by these Bylaws and any applicable state statutes, the Board of Directors shall be responsible for:

- i.** Clarification of and commitment to the organization's vision and mission.
- ii.** Interpretation of the mission to the general membership through public relationships.
- iii.** Establishment of goals, long-range plans, and strategic guidance.
- iv.** Setting policies and other major guidelines for operation of the organization.
- v.** Ensuring transparency and public accountability.
- vi.** Protecting the organization's financial stability and solvency.
- vii.** Establishing specific orders, resolutions, policies and procedures for the Executive Committee and staff to perform and/or apply to daily operations between meetings of the full Board of Directors.

(c) If a "Policy Manual" and/or "Procedure Manual" is maintained by the Association, it shall be subject to review and approved by the Board of Directors by January 31 of every even year or more frequently if the Board of Directors deems necessary. The entire contents of Policy and/or Procedure Manuals shall be accessible by all members and staff of the Association through the Members Only section of the NRHA website. There shall be no official policy or procedure represented, recognized or enforced by the Association or any representative thereof, other than those documented in a Policy and/or Procedure Manual. No policy or procedure shall supersede the Bylaws or Rules and Regulations of the Association.

Section 3. In the event the Board of Directors retains a person or qualified firm to be **Commissioner** of the Association, this person shall not be a member of the Board of Directors. The Board of Directors may retain a **Commissioner** to perform the

function for a contract term not to exceed sixty (60) months. The duties, function, and remuneration for the position of **Commissioner** will be dictated by the Board of Directors. The **Commissioner** shall be a position to work in conjunction with the President of the Association and not exclusive thereof.

(a) Under the direction of the President of the Association, the **Commissioner** shall be responsible for the safe keeping and maintenance of the policy and/or Procedure Manual, and the Corporate Record Book which shall contain the Articles of Incorporation, Bylaws, Active Board Resolutions, Rules and Regulations, Special Rules of Order, Standing Rules, official minutes of the Board of Directors and Executive Committee meetings, and quarterly and year-end financial statements, all of which shall be available for reference at each Board of Director's Meeting and accessible by all members and staff of the Association through the Members Only section of the NRHA website.

Section 4. In addition to the powers and authorities these Bylaws expressly confer upon them, the Board of Directors may exercise all such powers of the Association and do all such lawful acts that are not prohibited by statute or by these Bylaws.

Section 5. Board of Director Meetings.

(a) The Board of Directors of this Association shall have a regularly scheduled meeting during each fiscal quarter. However, in no event should more than 120 days pass before the next regularly scheduled meeting of the Board.

(b) The meeting of the Board of Directors may be held at such place within the state of Oklahoma or elsewhere, as the majority of Directors from time to time may determine, or as may be designated in the notice calling the meeting. Any meeting held outside the state of Oklahoma shall be considered solely for the convenience of the Board of Directors and shall not be considered as conducting business in the jurisdiction where the meeting takes place.

(c) Special meetings of the Board may be held at any time and place on the call of the President, a 2/3 majority of the Executive Committee or of a majority of the Board, in either case upon ten (10) days' notice by first-class prepaid mail, or five (5) days' notice delivered personally or by telephone or electronic mail. Such notice shall state the date, time and place of the meeting and shall be deemed given at the time when personally delivered, deposited in the mail, sent by electronic mail or orally transmitted to recipient via telephone.

(d) Any action required or permitted to be taken at any meeting of the Board of Directors, or of any committee thereof may be taken without a meeting if all members of the Board or committee, as the case may be, consent thereto in writing or by participation, and the writing or

acknowledgment of participation are filed with the minutes of proceedings of the Board or committee. Any Director or committee member may waive notice of any meeting. The attendance of a Director or committee member at a meeting shall constitute a waiver of notice of such meeting, except where a Director or committee member attends a meeting for the express purpose of objecting to the transaction of any business because the meeting is not lawfully called or convened. The business to be transacted and the purpose of any regular or special meeting of the Board of Directors shall be specified in a notice, or waiver of notice of such meeting. One or more directors may participate in a meeting of the Board, by means of teleconference or other similar audio/video communications equipment by means of which all persons participating in the meeting can hear and/or see each other.

(e) All Resolutions adopted by the Board of Directors shall be identified by both a numerical and subject index and shall be made a part of the Corporate Record Book. Resolutions may be amended or rescinded at a later date upon a two-thirds vote of the Board of Directors. Active resolutions shall be published on the Members Only section of the Association's website.

Section 6. Quorum. A quorum for the purposes of these Bylaws is defined as a majority of the members of the Board of Directors. Once it is established that a quorum exists, any question that may come before the meeting shall be decided upon by a simple majority of such quorum, with the exception however, that in extraordinary circumstances, if a majority of the directors to form the initial quorum is not achieved, then the presiding officer may determine if there is a minimum of 36% of the total Board members present, and, if so, continue the meeting and any question coming before the meeting would require a two-thirds majority to act as if the entire board were sitting.

Section 7. Any Board of Director that misses more than two (2) unexcused meetings per year may be removed for cause.

Section 8. By resolution of the Board of Directors, the Directors may be paid their expenses, if any, of attendance at each meeting of the Board of Directors and may be paid a fixed sum for attendance at each meeting of the Board of Directors or a stated salary as a Director. No such payment shall preclude any Director from serving the Association in any capacity and receiving compensation in addition to his fee of the Director.

Section 9. A Director of the Association shall stand in a fiduciary relation to the Association and shall perform his or her duties as a Director, including his or her duties as a member of any committee of the Board upon which he or

she may serve, in good faith, in a manner he or she reasonably believes to be in the best interest of the Association, and with such care, including reasonable inquiry, skill and diligence, as a person of ordinary prudence would use under similar circumstances. In performing his or her duties, a Director shall be entitled to rely on good faith information, opinions, reports or statements, including financial statements and other financial data, in each case prepared by any of the following:

- (a) One or more officers or employees of the Association whom the Director reasonably believes to be reliable and competent in the matters presented;
- (b) Counsel, public accountants or other persons as to matters which Director reasonably believes to be within a professional and expert competence of such person;
- (c) A Committee of the Board upon which he or she does not serve, duly designated in accordance with law, as to matters within its designated authority, which a Director reasonably believes to merit confidence.

A Director shall not be considered to be acting in good faith if he or she has knowledge concerning the matter in question that would cause his reliance to be unwarranted. In discharging the duties of their respective positions, the Director shall at all time use the skill and diligence a person of ordinary prudence would use in similar circumstances. So long as the Director uses such skill and diligence as a person of ordinary prudence would use under similar circumstances, he or she shall not be held personally responsible for any actions taken on behalf of the Association.

Section 10. Removal Any Officer, Director, or the president of the Reining Horse Sports Foundation may be removed from the Board of Directors by a majority vote of the Board of Directors whenever, in its judgment, the best interests of the association would be served thereby. However, such removal shall be without prejudice to the contract rights, if any, of the person so removed.

Section 11. An officer, director, employee, or staff member other than the President, attending an NRHA sponsored or approved event or any other horse show shall not attend in any official capacity unless authorized by the Executive Committee or the full Board of Directors as the case may be except for any official meeting.

Section 12. Confidentiality NRHA will protect its own confidential and proprietary information as well as the information entrusted by financial institutions, members and suppliers. Directors, officers, committee chairs/members, employees of NRHA and/or agents acting on behalf of the Association shall maintain in confidence among themselves all confidential and proprietary information and shall not disclose or distribute any confidential or proprietary information except when au-

thorized by the officers of the Association or compelled by statute. All confidential and proprietary information shall be utilized by those entrusted with it or granted access to it, only for the purpose(s) permitted in connection with their service to NRHA. Confidential information shall be those matters involving the following.

- (a) Any matter concerning NRHA personnel not otherwise publicly reported;
- (b) Issues relating to discipline, grievance and/or granting of Association privileges;
- (c) Terms of ongoing contractual negotiations and agreements;
- (d) Membership lists and associated personal information;
- (e) Communications from legal counsel relating to pending or threatened litigation;
- (f) And any other matter that is determined by no less than two-thirds (2/3) majority vote of the Board of Directors to be of a confidential nature. All other matters shall be considered common knowledge among the NRHA membership and staff.

ARTICLE VIII. COMMITTEES

Section 1. Standing Committees. The Association shall have the following Standing Committees which shall report directly to the Board of Directors. Any chairman or committee member of a Standing Committee may be removed by majority vote of the Board of Directors and their replacement selected in the same manner as the original appointment. The new member shall serve out the balance of the term of the member removed. Standing Committees shall keep minutes of their meetings and other records appropriate to their purposes and provide a quarterly report of their activities to the Board of Directors. With the exception of the Nominating Committee and the Compensation Committee, summaries of standing committee meetings shall be published in the Members Only section of the NRHA website. Standing Committee appointments shall be for the same two-year term as the incoming President.

(a) **Nominating Committee.** The Nominating Committee shall be comprised of no less than (3) three and no more than (5) five members of the Board of Directors of the Association. Members of this committee shall be appointed by a majority vote of the Board of Directors at the first board meeting of the year. The chairperson of this committee shall be selected from within the committee itself by the committee members. No member of the Executive Committee may serve on or ex officio as a member of this committee.

i. The Nominating Committee shall develop explicit criteria and qualities for board membership and submit to the full Board for approval.

ii. The Nominating Committee shall be responsible for submitting a list of qualified candidates for the annual election of officers by the general membership, having first determined the candidate meets the eligibility criteria and their willingness to serve as an officer of the association. At least two candidates shall be submitted for the position of Vice President.

iii. The Nominating Committee shall organize and oversee the Regional Director elections. They shall also assist the NAA Director elections to the extent of a written request for assistance is made by an NAA.

iv. The Nominating Committee shall develop recommended guidelines for the annual electronic internet vote and mail-in ballots and submit that proposal to the Board of Directors for approval.

v. The Nominating Committee shall be guided by Roberts Rules of Order Newly Revised and the American Bar Association's Guidebook for Directors of Nonprofit Corporations in executing their duties under this article.

vi. Additional duties and responsibilities of the Nominating Committee may be enumerated by Board Resolutions to be filed with the Active Resolutions in the Corporate Record Book.

(b) Finance Committee. The Finance Committee shall be comprised of no less than three (3) and no more than six (6) members. Three members shall be Board of Director members and up to three (3) additional members, who possess financial or accounting background, may be appointed from within or outside the board, but shall be NRHA members in good standing. The chairperson and members of this committee shall be appointed by the President of the Association with approval by the balance of the Board of Directors.

i. Duties of the Finance Committee. The Finance Committee shall have responsibility over the Association's auditing, accounting and control functions.

ii. The Finance Committee duties shall include, but are not limited to, choosing services needed in financial management, reviewing financial performance and approving the individual value center budgets prior to submission of the Association's annual budget to the Board of Directors for their approval. The Finance Committee shall monitor cash flow and provide quarterly financial reports to the Board of Directors. The Finance Committee shall be responsible to publish in the Members Only section of the NRHA website a quarterly financial report within 15 days after review by the Board of Directors and the annual audited financial statement within 4 months after the end of the fiscal year. The

Board of Directors may grant extensions to this time in 30 day increments on a case by case basis for reasonable cause when requested by the Finance Committee. The Committee shall ensure that the annual financial statement is presented to the general membership at the next Annual General Membership Meeting.

iii. Additional duties and responsibilities of the Finance Committee may be enumerated by Board Resolution to be filed with the Active Resolutions in the Corporate Record Book.

(c) Compensation Committee. The Compensation Committee shall be comprised of three (3) members of the Executive Committee of the Association. The chairperson and members of this committee shall be appointed by the President of the Association with approval by the Board of Directors.

i. Duties of the Compensation Committee. The Compensation Committee shall have the responsibility to recommend salaries for the Commissioner, the Chief Financial Officer, and any other staff positions as determined by the Board of Directors.

ii. The Compensation Committee's duties shall include completion of an annual performance evaluation on those positions determined in (i) above and make a report including necessary recommendations to the Board of Directors.

iii. Additional duties of the Compensation Committee may be enumerated by Board Resolution to be filed with the Active Resolutions in the Corporate Record Book.

(d) Investment Committee. The Investment Committee of the Association shall be comprised of the Executive Committee with the Reining Horse Sports Foundation President and the Chief Financial Officer of the Association serving as advisors to this committee.

i. The duties of the Investment Committee shall be to evaluate the Association's short-term, mid-term and long-term financial needs relative to the investment of the Association's cash assets and to present an investment policy for approval to the Board of Directors. The Investment Committee shall consult with professional investment counsel in this endeavor. Following approval of the investment policy by the Board of Directors, the investment Committee shall proceed with the investment decisions made, monitor closely the performance of the investments and make necessary adjustments to achieve the overall investment goals of the Association. The Investment Committee shall keep minutes of their meetings and provide quarterly reports of their activities to the Board of Directors. Summaries of current Investment Committee activity shall be published on the Members Only section of the NRHA website.

ii. Additional duties of the Investment Committee may be enumerated by Board Resolution to be filed with the Active Resolutions in the Corporate Record Book.

(e) Bylaw Committee. The President, at the beginning of his/her term of office shall appoint a Bylaw Committee, comprised of no less than three (3) and no more than six (6) members. These appointments shall be approved by the Board of Directors. Bylaw Committee duties and responsibilities shall be:

i. To review bylaws and make recommendations to the Executive Committee for maintenance as necessary.

ii. To receive and review all bylaw amendment proposals that may be submitted by any member, committee or board.

iii. To work with the author of any bylaw amendment proposal submitted to determine the desired intent of the proposed amendment and further refine the wording if necessary to achieve the desired result.

iv. To work with the author of any bylaw amendment proposal submitted to assure the language is in proper form as it relates to the governance, operations and functions of the Association.

v. To assure any bylaw amendment proposal being submitted complies with the Articles of Incorporation, Oklahoma State Statutes, Federal law, and does not conflict with Roberts Rules of Order Newly Revised or any Special Rules of Order of this Association.

vi. To recognize duplicate or similar bylaw amendment proposals submitted and work with their authors to consolidate, modify or otherwise reduce the number of proposals addressing the same or similar issue.

vii. To collect from the authors or proponents of the proposed bylaw amendment, a statement in support of the amendment that presents the benefit(s) of this amendment to the Association and, with the approval of its authors, edit this statement so that it is suitable for publication and presentation to the voting membership.

viii. To accept from opponents of the proposed bylaw amendment, a statement against the amendment that presents the negative impact this amendment would make upon the association and, with the approval of its authors, edit this statement so that it is suitable for publication and presentation to the voting membership.

ix. To compile proposed bylaw amendments and statements for and against each into a publication or presentation format that can be attached to an email, reproduced in the *NRHA Reiner*, posted on the NRHA website, and incorporated into electronic and paper ballots.

- x. The Bylaw Committee shall work from an unbiased position toward any proposed bylaw amendment received. They shall not edit any proposed amendment or statement except with the permission of the author, nor shall they continue edits after the author has approved a final version of the proposed amendment or statement. The committee does not have the authority to approve or deny the submission of any proposed amendment unless its intent or the result of its application is contrary to the NRHA Articles of Incorporation, Oklahoma State Statutes, or Federal law.
- xi. Additional duties of the Bylaw Committee may be enumerated by Board Resolution to be filed with the Active Resolutions in the Corporate Record Book.

Section 2. Additional Committees. The Board of Directors may authorize additional committees to be utilized for assistance in the operation and management of the Association. Such committees shall be formed by board resolution which shall define the committee name, the purpose of the committee and committee guidelines to be followed. This resolution shall become an Active Resolution to be filed in the Corporate Record Book and may be modified or rescinded by the Board of Directors.

(a) Upon direction of the Board of Directors, the President shall appoint a committee Chairperson of such committee. Regional or NAA Directors shall be given first consideration for Chairperson positions.

(b) The Chairperson shall appoint the members of their respective committee. The Committee shall consist of the Chairperson, a Vice-Chairperson and a minimum of three (3) additional members. All appointments shall be made for a two (2) year term which shall coincide with the term of the incoming President. Should a Chairperson vacancy occur for any reason, the President shall appoint a new Chairperson to fill the remainder of the term, giving first consideration to those current members of the respective committee. If a vacancy appears among committee members, the chairperson shall appoint a new member to fill the remainder of the term. All chairperson and committee member appointments are subject to the approval of the Executive Committee.

(c) The chair of an additional committee may be removed by a majority vote of the Executive Committee.

(d) Responsibilities, tasks, and projects may be assigned to a committee by the President, Executive Committee or Board of Directors. The committee Chairperson shall preside over the activities of the Committee.

(e) Committees shall each be assigned a member of the

Association staff to serve the committee in a liaison capacity. The Staff Liaison shall be a non-voting support person functioning under the direction of the committee Chairperson. (f) Committees shall keep minutes of their meetings and provide quarterly reports of their activities to the Board of Directors. When Committees are engaged in matters that involve presenting a recommendation to a higher authority, they shall submit a Committee Recommendation Report on the issue at hand to the respective higher authority. This report shall become a part of and published with the permanent minutes of the meeting in which it is presented. Summaries of current individual committee activity shall be published on the NRHA website.

(g) No person shall be involved, as chairperson or member, with more than three (3) Additional Committees simultaneously during their term in office.

(h) Officers may only be involved in committees ex-officio as a member with the exception that no officer shall serve on or ex-officio as a member of the Nominating Committee.

(i) Advance selection of committee chairs and committee members shall be accomplished during the last quarter of the preceding term year by the incoming Executive Committee in order to accomplish education and orientation for all newly elected chairpersons prior to the first official board meeting of the new calendar year.

Section 3. Task Force. The Board of Directors, President, or Executive Committee may commission a Task Force which shall be utilized for a specific purpose of limited scope and duration.

(a) The Task Force shall be active only until the assigned task is completed and a formal written report has been prepared at which time the Task Force shall be dissolved.

(b) A Task Force shall consist of at least five (5) but no more than nine (9) members and one (1) Chairperson, all appointed by the President. Should a chairperson vacancy appear for any reason, the President shall appoint a new Chairperson for the duration of the Task Force, giving first consideration to those current members of the Task Force. If a vacancy appears among members, the President may appoint a new member for the duration of the Task Force.

(c) All appointments shall be subject to the approval of the Board of Directors.

(d) The task, project, and responsibility of the Task Force shall be directed by the authority calling for the appointment of the Task Force.

(e) The Chairperson shall preside over the activities of the Task Force.

(f) A Task Force shall be assigned a member of the Association

staff to serve in a liaison capacity. The Staff Liaison shall be a non-voting support person functioning under the direction of the Chairperson.

(g) The Task Force shall keep minutes of their meetings and provide a monthly report of their activities to the Board of Directors. Findings and recommendations of the Task Force shall be published in the “Members Only” section of the Association’s website unless it has been determined by a two-thirds majority vote of the Board of Directors that the activities, findings and recommendations of subject Task Force are to be considered confidential.

ARTICLE IX. NRHA AFFILIATES

Section 1. NRHA recognizes the following types of affiliates:

(a) National Association Affiliates

- i. Only one affiliate per country will be recognized as a “National Association Affiliate.”
- ii. Must have twenty-five (25) members in good standing with the NRHA.
- iii. At least four (4) NRHA approved shows with full slates of classes must be held within each respective country, during the previous calendar year.
- iv. Each National Association Affiliate must submit annually a summary report of its past and current year activities and future plans to promote reining and NRHA in their respective country. If the NAA participates in the International Affiliate Program as outlined in General Rules and Regulations, they must report financial information on the distribution of IAP rebates.

(b) Breed Association Affiliates

- i. Must have ten (10) members that are in good standing with the NRHA.

(c) Regional Affiliates

- i. Must have twenty-five (25) members that are in good standing with the NRHA.
- ii. No more than one (1) Regional Affiliate will be sanctioned within a 50-mile radius. Affiliates in good standing have first priority.
- iii. If annual dues are not received by the NRHA office by March 1 of the current year and the affiliate did not hold Reining events the previous year, that geographical area will become available for the formation of a new affiliate.

Section 2. Each NRHA affiliate must have on file with the NRHA a properly executed NRHA Agreement of Affiliation as prepared by the Affiliate Committee and approved by the NRHA Board of Directors. Additionally, the affiliate must also send to the National Reining Horse Association annual dues to be set by the Board of Directors and otherwise comply with the NRHA Rules and Regulations.

Section 3. An affiliate in good standing has the right to

recommend to the Board of Directors, one representative whose name will be published in the *NRHA Reiner* magazine.

Section 4. All NRHA Affiliate officers must be members in good standing with NRHA.

Section 5. Affiliation with the NRHA is a privilege, not a vested right, and is granted or rejected at NRHA's discretion on an annual basis according to its procedures and requirements.

Section 6. All affiliate associations are required to have Bylaws. If an affiliate does not have a specific set of Bylaws written on its behalf, it must adopt the Bylaws of the NRHA. All affiliates are required to have either their Bylaws, together with any and all amendments, or a proper resolution adopting the NRHA Bylaws for itself on file with the NRHA. All affiliates are required to follow the rules as set forth in the *NRHA Handbook*. Prior to becoming an affiliate, the Bylaws of the new affiliate must be approved by the Executive Committee. Any subsequent changes in the Bylaws of the affiliate must also be approved by the Executive Committee.

Section 7. No affiliate association shall have, in any manner, the authority, express or implied, to act for, or bind, the NRHA in any manner.

Section 8. NRHA does not assume responsibility for the acts or omissions of its affiliate associations, their officers, directors, employees, or any other of their representatives.

Section 9. Within one year, affiliates will be expected to develop and maintain a website for the purpose of communicating with their members and with NRHA. All affiliate websites will be linked to the NRHA website.

ARTICLE X. PARLIAMENTARY AUTHORITY

Section 1. The rules contained in the current edition of *Robert's Rules of Order Newly Revised* shall govern the Association in all cases to which they are applicable and in which they are not inconsistent with these bylaws and any special rules of order the Association may adopt. Any Special Rules of Order must be approved within a bylaw amendment pursuant to Article XV.

ARTICLE XI. ANNUAL STATEMENTS

Section 1. An annual audit of the NRHA financial statements shall be performed by an independent certified public accounting firm at the close of each fiscal year. Results of said audit will be reported at the next general meeting of the membership following the completion of said audit and published on the NRHA website within four months after the close of the fiscal year or within any extension that may be granted by the Board of Directors pursuant to ARTICLE VIII, Section 1. B) ii. Such accounting firm shall be an independent as defined by the AICPA (American Institute of Certified Public Accountants) Independence guidelines.

ARTICLE XII. INDEMNIFICATION

Section 1. The Association shall indemnify each of its directors, officers, employees and committee members whether or not then in service as such, against all reasonable expenses actually and necessarily incurred by him or her in connection with the defense of any litigation to which the individual may have been a party because he or she was a director, officer or employee of the Association. The individual shall have no right to reimbursement, however, in relation to matters as to which he or she has been adjudged liable to the Association for negligence or misconduct in the performance of his or her duties, or was derelict in the performance in his or her duty as a director, officer or employee by reason of willful misconduct, bad faith, gross negligence, or reckless disregard of the duties of his or her office or employment. The right to indemnity for expense shall also apply to expense of suits which are comprised or settled if the court having jurisdiction of this matter shall approve such settlement.

The foregoing right of indemnification shall be in addition to, and not exclusive of, all other rights which such director, officer or employee may be entitled.

ARTICLE XIII. CONTRACTS, LOANS, CHECKS AND DEPOSITS

Section 1. Contracts. The Board of Directors may authorize any officer or officers, agent or their designees, to enter into any contract or execute and deliver any instrument in the name of and on behalf of the Association, and such authority may be general or confined to specific instances. This authority in no way conflicts with the authority of the President to enter into agreements as set forth under the obligations and duties of an officer.

Section 2. Loans. No loans shall be contracted on behalf of the Association and no evidence of indebtedness shall be issued in its name unless authorized by a resolution of the Board of Directors. Such authority may be general or confined to specific instances.

Section 3. Checks, Drafts, etc. All checks, drafts or other orders for the payment of money, notes, or other evidence of indebtedness issued in the name of the Association shall be signed by such officer or officers, agent or agents of the Association and in such manner as shall from time to time be determined by resolution of the Board of Directors.

Section 4. Deposits. All funds of the Association not otherwise employed shall be deposited from time to time to the credit of the Association in such banks, trust companies, or other depositories as the Board of Directors may select.

ARTICLE XIV. MISCELLANEOUS PROVISIONS

Section 1. All checks or demands for money and notes of the Association shall be signed by such officer or officers or their designees, as the Board of Directors may from time to time designate.

Section 2. Whenever written notice is required to be given to any person, it shall be given in writing to and delivered by first-class, prepaid mail, telecopy, personal delivery, overnight courier, or electronic mail. Any notice given must be given to the last address, telecopy number or electronic mail address of the member shown on the Association's records. Notice shall be deemed given at the time of delivery through the means of delivery utilized, and, if for meetings, shall state the date, place and hour of the meeting and purpose or purposes for which the meeting is called.

Section 3. Whenever any written notice is required by statute, or by the Bylaws of this Association, a waiver thereof in writing, signed by the person or persons entitled to such notice, whether if before or after the time stated therein, shall be deemed equivalent to the giving of such notice. Attendance of a person, at any meeting, shall constitute a waiver of notice of such meeting, except where a person attends a meeting for the expressed purpose of objecting to a transaction of any business because the meeting was not lawfully called or convened.

Section 4. Minutes and Financial Reports. The minutes of all Board of Director meetings, Executive Committee meetings, and committee meetings shall be published on the NRHA Members Only section of the NRHA website. Included in those minutes shall be the attendance, absence or excused absence of members of the respective board or committee. Voting results for rule changes shall be recorded and reported so that the general membership can see how their elected representatives are voting. Only the Board of Directors and Executive Committee meeting minutes shall be published in the *NRHA Reiner*. Issues relative to disciplinary proceedings of individual members shall be handled pursuant to Section C-H of the General Rules and Regulations of the *NRHA Handbook* and the details of those proceedings shall not be published. Minutes of meetings called for within this section shall be published no more than 120 days after the respective meeting for which they pertain.

ARTICLE XV. AMENDMENTS

Section 1. Amendments to the Bylaws may be submitted by any member, committee or board and must be properly stated on the official Bylaw Amendment Form, signed by two members, and submitted to the NRHA office at least ninety (90) days prior to the date of the annual elections established by the Board of Directors. Written notice of the proposed amendments shall be listed in detail on the NRHA website and in the NRHA official publication or by a special mailing to the membership at least thirty (30) days prior to the annual elections. These amendments will be considered and voted on during the annual elections, and must be passed by two-thirds of the members voting.

Thank You

For your continued support of our association and events!

NRHA CORPORATE PARTNERS



ELECTION PROCEDURES

This section of the NRHA Handbook addresses the Election Procedures approved by the NRHA Board of Directors pursuant to Article V and Article VII of the NRHA Bylaws.

On an annual basis, NRHA conducts elections for Directors-At-Large, Bylaw Amendment Proposals and Regional Directors (staggered terms). Biennially, elections for a new Vice President are held. All elections are conducted under the procedures defined herein. The Board of Directors may amend these procedures as necessary pursuant to their authority under the Bylaws. Election Procedures for NAA Directors and European Regional Directors are also addressed herein and within the respective NRHA Bylaw.

Section 1. Election Procedures Overview

- (a) Each election conducted by NRHA may be conducted as a completely separate election with unique nomination deadlines, voting ballots and election dates.
- (b) The Nominating Committee shall develop a list of desirable attributes that candidates should possess. This list shall be included in the Nomination Criteria (See Section IV below).
- (c) For procedures regarding NAA Director Elections, see Article VII, Section 1(c) and (d) of the Bylaws.
- (d) For Directors-At-Large and Vice President Elections, refer to Article V. Sections 1–6 of the Bylaws.
- (e) For Bylaw Amendments, refer to Article XV of the Bylaws.

Section 2.

The NRHA Board of Directors has created a European Region comprised by all the countries of Europe. The NRHA Affiliates within the Region will form the EAC. See the current NRHA BOD Resolution for outlined duties & responsibilities.

- (a) The EAC will be made up of Delegates from all the Affiliates in the European Region with at least 25 NRHA members. Countries with more than 200 NRHA members will receive a second EAC Delegate. Additional EAC Delegate(s) will be added from each country when its NRHA membership reaches 500 and for each additional 500 NRHA members. Each Affiliate will develop election procedures that comply with the laws of its respective country. Each EAC Delegate will be elected for a two year term.
- (b) EAC Delegates elected to serve on the NRHA Board of Directors, as NRHA Regional Directors, will be selected in the following manner:
 1. Each European NAA that has NRHA membership in excess of 500 will be entitled to elect one of its EAC Delegate members to serve on the NRHA Board of Directors.
 2. The remaining NRHA Board of Director seats will be elected by the EAC Delegates. (See NRHA Bylaws Section VII.)

3. More than one EAC Delegate may be elected to the NRHA Board of Directors from the same Affiliate.
 4. NRHA Regional Directors shall be elected on staggered term basis in order to have approximately 50% of the Regional Directors overlapping their second year of a two-year term along with the first year of incoming newly elected Regional Directors.
 5. During the 2013 transition elections to staggered terms, the EAC may select which group will serve the first two year term and which group will serve an initial three year term.
- (c) The EAC Delegates elected to serve as Regional Directors on the NRHA Board of Directors, will comprise the EAC Executive Committee.
1. The EAC Executive Committee shall elect a President and Vice President from its members.

Section 3. Nominations

- (a) Candidate nomination criteria, as described in this document, shall be compiled into a “Nomination Guidelines” document for publication on the NRHA website and in the *NRHA Reiner*.
- (b) The open date and closing deadline of the nomination period will be unique to the date of each election conducted by NRHA.

(c) Directors-At-Large/Vice President nominations:

- i. The Nominating Committee shall submit a list of candidates for Directors-At-Large/Vice President to the NRHA Board of Directors no less than ninety (90) days prior to the start of the annual election. Write-in candidate nominations shall be submitted to the NRHA office no less than sixty (60) days prior to the start of the annual election (Art. V, Section 3 of the Bylaws).
- ii. The Elections Administrator shall conduct the Annual Elections in accordance with the procedures contained within the board approved Election Administrator’s Manual.

(d) Regional Director nominations:

- i. For Regional Directors, each Region’s nomination period shall close no sooner than ninety (90) days before the start of that respective region’s RAF or other approved election dates for foreign Regional affiliates. Write-in candidate applications shall close no sooner than sixty (60) days before the start of that respective region’s RAF or other approved election dates for foreign Regional affiliates.
- ii. The Nominating Committee shall accept nominations up to the close of nomination deadlines for each regional election being conducted.
- iii. Regional Director Candidate nominations may be made by affiliates. Nominations must be made in the form of a letter upon affiliate letterhead and signed by an officer of the affiliate. The language must include “The (name of affiliate) nominates (name of candidate), (NRHA #) as a

candidate for Regional Director of the (name of region) for the (year) election.” A biography of the candidate, including their credentials, must accompany the nomination letter. Only one candidate is allowed per nomination letter. There is no limit to the number of nominations that can be made by an affiliate. Affiliates shall only nominate candidates to represent their respective region.

iv. Write-in candidates may be accepted if the nomination is accompanied by a minimum of ten (10) signatures from members in good standing residing within the respective region. The nomination language must include “(name of candidate), (NRHA #) desires to run for Regional Director of the (name of region) for the (year) election. This request is supported by the members listed below.” On the same document, supporting members must sign and print their names and provide their NRHA number. A biography of the candidate including their credentials must accompany the nomination.

v. The Nominating Committee shall monitor incoming nominations to assure that at the least the minimum number of candidates nominated in each region will fill the number of Directors relative to that region and shall take action to stimulate nominations if any Region is not generating enough nominations to fill the respective number of Director positions open in that region. Such action would include:

(a) Sending notices directly to each affiliate in the region.

(b) Networking for candidate recommendations that the Nominating Committee could then encourage an affiliate to nominate.

(c) Networking for candidates to be write-in nominees.

vi. The Nominating Committee shall verify that candidates meet the requirements of the position. The Nominating Committee shall also verify that candidates understand the commitments of serving on the Board of Directors.

vii. Candidate biographies shall be organized by region for publication on the NRHA website, in the *NRHA Reiner* magazine, and distributed to respective affiliates for inclusion in their newsletters.

viii. The Elections Administrator shall conduct the Regional Directors Elections in accordance with the procedures contained within the board approved Election Administrator’s Manual.

Section 3. Elections

(a) Annual elections shall be conducted by online electronic voting (eBallot) and/or alternative mail-in absentee paper balloting.

(b) Directors-At-Large/Bylaws/VP elections shall be governed by Article V and Article XV of the Bylaws.

(c) Regional Director election dates shall be determined for each region based on the dates of their respective Regional Affiliate Finals (RAF) within North America or other approved election dates for foreign Regional affiliates, which will allow at least thirty (30) days for votes to be placed either electronically online, or by absentee paper ballot. The eBallot online voting option and mail-in absentee paper ballot voting shall terminate 7 days prior to the start of the RAF. Voting in person by paper ballot shall be available during the RAF on the RAF show grounds and shall terminate at 2:00 p.m. on the last Saturday of each respective RAF.

(d) An NRHA staff member shall be designated “Elections Administrator.” This person should also be the Nominating Committee’s staff liaison. He/she shall:

- i.** Agree to maintain the integrity and confidentiality of the Regional Director elections.
- ii.** Set up the online eBallots with the assistance of and under the direction of the Nominating Committee.
- iii.** Interface with eBallot as necessary.
- iv.** Draft and send election notices and voting instructions.
- v.** Maintain voter eligibility lists specific to each region and integrate them with the eBallots.
- vi.** Fulfill requests for paper ballots.
- vii.** Input properly completed and sealed paper ballots in the eBallot system.
- viii.** Finalize the tally of each regional director election and announce the results.

(e) During the week before each region’s election opens, all members of the respective region will be provided with voting instructions and unique login password that will allow access to their specific region’s online eBallot. The Elections Administrator shall only provide voting credential information directly to the email of record or personal address of an eligible NRHA member and to no other party. Instructions will contain information about how a paper ballot may be obtained if a member chooses not to vote electronically.

(f) Members with e-mail addresses on file with NRHA will receive this information via e-mail. Members without an e-mail address on file, and those with e-mails that bounce back, will be sent this same information by regular mail. This Section III. F. shall also apply to Directors-At-Large/Bylaws and Vice President elections governed by Article V and Article XV of the Bylaws.

(g) Any eligible member choosing to vote by traditional paper ballot may e-mail, fax, or call the NRHA Elections Administrator to request an absentee paper ballot. (No ballots will be printed in the *NRHA Reiner* or available for download off the website)

(h) Voters choosing to use paper ballots shall include their NRHA number, signature, printed name and date where indi-

cated on the ballot. They shall place the ballot into an envelope, seal it, and sign their name ACROSS the seal. Any incomplete ballot or improperly sealed ballot envelope shall render the ballot invalid.

(i) Sealed paper ballots shall be mailed/delivered to the NRHA Elections Administrator, who is the only person allowed to open them. Upon opening a ballot envelope, the Elections Administrator shall immediately input the absentee paper ballot vote into the eBallot system, thereby integrating it with the online voting process where it will be included in the results of the election. All paper ballots shall be input no later than the end of the business day following the day they are received by the Elections Administrator.

(j) The NRHA staff person who attends each RAF shall work in conjunction with the Elections Administrator and agree to uphold the integrity of the election. They shall also work in conjunction with the hosting affiliate to conduct paper balloting, which will be available until 2:00 p.m. on the last Saturday of the respective RAF at which time the NRHA staff person shall be responsible to collect any paper ballots completed during the RAF, count the votes, add these paper ballot totals to the eBallot totals provided by the Elections Administrator and produce the results of the election by that same Saturday evening during the RAF show. The NRHA staff person shall return the paper ballots collected at the RAF to the Elections Administrator where they will be counted a second time and the results validated.

(k) Upon completion of the validated final tally by the Elections Administrator, the respective region's election results shall be immediately released via e-mail notice to all affiliates within the respective region and published on the NRHA website and in the NRHA Reiner magazine.

(l) Any paper ballots submitted for each respective election shall be retained for thirty (30) days. If the viability of the election is not questioned during that time they shall be shredded.

Section 4. Nomination Criteria

The Nominating Committee will accept nominations for regional director candidates based on the following criteria:

(a) Nominations. Candidates are nominated to serve for two year terms. Nominations may be made by affiliates or may be written-in.

(b) Qualifications. Candidates should possess the following attributes:

- i. Knowledge of the reining horse industry.
- ii. Evidence of commitment to the Association's objectives through personal involvement in the industry (diversity of non pros, professionals, judges, breeders, stallion owners, etc.).
- iii. Potential to bring a special expertise or experience to

the board (i.e. background in general management, accounting, legal, marketing, advertising, promotions, sponsorships, human resources, information technology, show production and management, breeding, training, etc.)

iv. Prior board-level experience at the regional/affiliate level or within some form of nonprofit entity.

v. Willingness to support board views even when not personally in agreement.

(c) Commitment.

i. Ability to serve knowing the time commitment expected of them.

ii. Financially willing to commit to the expense, which could include at least the procurement of a personal computer and accessories, if necessary, for video conferencing (web cam, microphone, broadband connection) and at most for personal travel, airfare, lodging, transportation and meals when attending a minimum of four (4) Board of Directors meetings per year.

iii. Time commitment to participate in meetings either in person or via teleconference and/or video conference meetings (if available), and willingness to become educated about issues at hand as necessary.

iv. Willingness to actively serve on board-level committees as chair/vice chair or member.

(d) Requirements. Candidates must:

i. Be at least 25 years of age.

ii. Be a citizen of the country that is associated with a region for which they are nominated.

iii. Be a permanent resident of the region they are nominated to represent.

iv. Be a current member of the affiliate that nominated them. A write-in candidate requires no affiliate membership.

v. Be a member in good standing with NRHA for a period of not less than two (2) years.

(e) Directors-At-Large/Vice President Criteria. Inasmuch as candidates for Director-At-Large/VP must have served at least one year as a director, they will have met all the above criteria. Additional criteria to serve as an officer of the Association may be recommended by the Nominating Committee and approved by the Board of Directors.

Section 5. Staggered Terms

(a) Regional Directors shall be elected on a staggered term basis in order to have approximately 50% of the board overlapping their second year of a two-year term along with the first year of incoming newly elected board members. This will provide the Association with continuity in operations and provide incoming board members with seasoned board members with whom to interact and be mentored.

(b) The following Regions shall have their directors to the NRHA

Board elected during odd calendar years: EC, NC, NE and NW.
(c) The following Regions shall have their directors to the NRHA Board elected during even calendar years: SC, SE, SW and MTN.

Section 6. Translation of Election Information.

The European Affiliate Council and other National Association Affiliates (NAA's) throughout the world are encouraged to obtain complete election information from the NRHA Elections Administrator, including voting instructions, candidate biographies and bylaw amendment proposals, and to have those documents translated into the appropriate language that the majority of their local NRHA membership will be able to read and easily understand.

Section 7. Eligibility To Vote.

(a) Pursuant to Article II. Section 8 of the Bylaws, voting by members in any NRHA election shall be limited to individual memberships and the member must be 19 years of age or older on January 1 of the election year and be in good standing with the association upon receiving voting credentials for the respective upcoming election. Membership numbers issued and recorded as a Joint, Corporate, Syndicate, Associate, Alliance, Affiliate, NAA, etc., are not considered individual memberships and are not eligible to vote in an NRHA election. Youth members are not eligible to vote in the Annual or Regional Director elections. No individual member shall vote more than one ballot in any election.

(b) Voting credential information shall only be sent to individual members at their current email or physical mailing address of record in the NRHA database.

(c) Membership numbers of only those individuals eligible to vote in NRHA elections and youth members on December 31st of the prior year shall be used to determine director allocations from those Regions/NAAs. Refer to Article VII. Section 1 of the Bylaws.

NRHA MANEUVER STANDARDS

Secrets of the NRHA Judges

EXPOSED

Find Out The Secrets
TO GET THE SCORE

Master All Of The
MANEUVERS

Learn The Latest
STANDARDS

The NRHA Judging Maneuver Standards DVD will help you assess and understand the definition of reining, maneuver scoring, penalty application and scoring live runs.

Score the Two Disc Set

ONLY \$39⁹⁵

NRHA 
NATIONAL REINING HORSE ASSOCIATION

3000 NW 10th Street, Oklahoma City, OK 73107-5302
405-946-7400 • insidereining.com

GENERAL RULES AND REGULATIONS

A. RULE CHANGE PROCEDURES

Section 1. Rule change submissions that may add, alter, or amend any rule in the *NRHA Handbook* may be submitted by any NRHA member in good standing, NRHA Committee, NRHA Staff, NRHA Board of Directors, NRHA Executive Committee or NRHA Task Force.

Section 2. A rule change proposal must be reviewed at a minimum of two NRHA Board of Director meetings and published and presented to the general membership in the *NRHA Reiner* magazine and on the NRHA website. The last date of submission for rule changes will be published in the *NRHA Reiner* and on the NRHA website. All rule changes must be voted on by the Board of Directors and only the NRHA Board of Directors may pass a rule change. The author of a rule change may withdraw the proposal at any time prior to the first review of the rule change by the Board. The NRHA Board of Directors may vote to approve, modify and approve, or recommend the rule change be reviewed by the appropriate committee(s) prior to the date of the vote. On the date(s) of the vote, the rule change will either be passed or defeated as written, passed or defeated as amended or no action will be taken.

Section 3. Each committee may review any proposed rule change and provide a recommendation to approve or disapprove the rule changes.

Section 4. During the course of the day to day management of the association, if the occasion should arise that is not clearly written or defined by the *NRHA Handbook*, in the best interest of the association and its members, the Officers of the Association are empowered to make clarifications as needed to the *NRHA Handbook*. Any changes under this provision would then be corrected in the manner outlined in the *NRHA Handbook*.

B. AFFILIATE COMPLIANCE

Renewing Affiliates shall submit a complete and correct annual renewal application listing officers who are NRHA members in good standing and dues, for the current year to NRHA by January 31 of each year. Affiliates failing to submit completed and correct renewal applications by January 31 or whose renewal applications remain incomplete or incorrect after January 31, will realize all NRHA business including show approval, will be held in a suspended status until a complete and correct renewal application has been presented to NRHA or until March 1 whichever comes first. If a complete and correct renewal application is still outstanding by March 1 of the current year Affiliate status will be annulled. If the Affiliate Officers are not current members of NRHA in good standing by March 1 of the current year, Affiliate status will be annulled. Annulment of Affiliate status will be published in the *NRHA Reiner*.

After March 1, an annulled Affiliate may re-apply for renewal by paying a re-instatement fee of \$50 and resubmitting a complete and correct affiliate application representing officers who are current members of NRHA in good standing.

C. INTERNATIONAL AFFILIATE PROGRAM

Designation as an NRHA National Association Affiliate is a privilege, not a right, bestowed by the NRHA Board of Directors, according to procedures formulated by the Executive Committee of the NRHA.

Section 1. National Association Affiliate Rights and Responsibilities:

(a) Once the privilege of regional affiliate is granted, and the regional affiliate has been an affiliate in good standing for at least a year and has 25 members and meets the show requirements of the NAA program, the regional affiliate will have the right to apply for the NRHA National Association Affiliate program. Each affiliate wishing to participate in the National Association Affiliate program shall apply to the NRHA by October 31 of the year prior if it wishes to adopt the program.

(b) Once the privilege of National Association Affiliate status is granted and it has reached 100 NRHA members, the National Affiliate will have the right to apply for the NRHA International Affiliate Program. Each National Association Affiliate will inform the NRHA by October 31 of the year prior whether it wishes to adopt the program.

Section 2. NRHA International Affiliate Program Rights and Responsibilities:

(a) The National Association may elect to establish a joint membership between the National Association Affiliate and the NRHA.

(b) All Reining events will be NRHA approved.

(c) All records will be maintained in the official NRHA database.

Section 3. In support of the International Affiliate Program, NRHA will agree to the following:

(a) NRHA recognizes the National Association Affiliate as the organization to provide governance and leadership for the sport of Reining on a national level within that country.

(b) NRHA will rebate to the National Association Affiliate \$20 for each member in their country that has NRHA General membership.

(c) NRHA will rebate to the National Affiliate fifty percent (50%) of NRHA's show fees for every show that is NRHA approved and held either inside of the country's geographic borders, or run under the auspices of that National Association Affiliate.

(d) NRHA will authorize all protests originated within a respective country to be adjudicated by the National Association Affiliate. The appeal process will be to the NRHA Executive Committee.

(e) NRHA will authorize the National Association Affiliate to make a recommendation on all show approvals within that country.

(f) NRHA will provide database information requested by the National Association Affiliate. NRHA will maintain historical records for National Association Affiliates participating in the International Affiliate Program.

D. DISCIPLINARY PROCEDURES

Section 1. Membership in the Association carries responsibilities as well as certain rights. Any member of the Association may be disciplined, fined, or have their membership revoked or suspended upon a showing of good cause. Any non-member may be denied membership and the privileges relating thereto whenever it shall be established by satisfactory evidence to the NRHA Executive Committee that such non-member is not a worthy candidate.

Section 2. Anyone who becomes a member of the Association or is subject to any portion of the Bylaws, rules and regulations accepts and agrees to be bound by all the Bylaws, rules and regulations of the Association and all terms and conditions of this *Handbook*.

Section 3. Anyone who becomes a member of the Association or is subject to any portion of the Bylaws, rules and regulations and terms and conditions of this *NRHA Handbook* renounces any recourse, which he or she may have against the Association in connection with the enforcement of those rules. This would include any associated or related corporation, trust or other business entity.

Section 4. Protest and Complaint Filing Procedures.

(1) Violations, including false declarations, of the NRHA Handbook discovered by NRHA during the course of business shall be referred to the NRHA President, Commissioner and Legal Counsel to determine the need to refer to a hearing body.

(2) **Protest Filing:** Whenever any current member believes that conduct of a member or non-member warrants disciplinary action, or whenever any current member believes that a violation of these Rules and Regulations at an NRHA Approved Event has occurred, he or she must file within fifteen (15) days of the actual incident, and/or within fifteen (15) days of having gained knowledge of the incident, a valid written, signed protest or complaint with the NRHA office. NRHA may act on infractions outside fifteen (15) days when deemed by NRHA to serve to protect the integrity of the association, welfare of the horse or safety of NRHA members.

(3) Protest Filings for which \$100 filing fee is waived:

(a) Standing or Additional Committee, as a committee and/or the chairman of the committee, if the alleged rule violation falls within that committee's domain.

(b) Show Steward/Show Representative involved as officials

at an event who are not directly involved as an exhibitor of a particular class in question.

(c) Judges Grievance setting forth conduct warranting disciplinary action. See Judges Guidelines.

(d) Show Management or Show Secretary involved as officials at an Event.

(4) Protest submissions are not considered valid without the appropriate information. Required criteria needed to properly submit a protest or complaint shall include:

(a) Name of accused

(b) Event name, date and location

(c) Accused allegation

(d) Witness list with contact information

(e) Detailed description and/or evidence of the accused allegation.

(f) \$100 non-refundable filing fee

(5) Past history may be considered for all disciplinary matters.

(6) The Executive Committee may, by giving written notification, temporarily suspend a member for any action considered egregious, the effect of that shall be to deny further NRHA privileges until the Investigative Review Committee and/or Hearing Body can hear this matter and take appropriate disciplinary action.

Section 5. Investigation Review Committee.

(1) The Investigation Review Committee (IRC) shall be composed of three (3) members of the Board of Directors. One (1) member will be appointed as manager of IRC and will be responsible for presenting facts to the Hearing Body if deemed necessary.

(2) It shall be the duty of the NRHA President to appoint members from the Board of Directors to serve on an IRC.

(3) Each protest or complaint properly filed will be assigned to an IRC.

(4) The IRC is responsible for a preliminary review on the assigned protest or complaint.

(5) The IRC review may result in rejection of the case or advancement of the case to the full Hearing Body for final resolution.

(6) If the IRC finds the matter is not sufficiently serious to warrant a hearing, all parties will be advised accordingly. However, the IRC may issue a letter of concern or reprimand to any party or parties relative to the matter under consideration.

(7) If the IRC finds that a hearing is warranted, the accused shall be given not less than thirty (30) days' notice of time and place of hearing before the Hearing Body.

(8) For those cases designated for advancement, the manager of the IRC will have the responsibility, of presenting the facts of the case at the hearing. The manager will not be a voting member during hearing.

(9) The makeup of the IRC, all evidence, statements and documents relating to a case will be confidential.

(10) The NRHA Board of Directors may remove any member of the IRC at any time for any reason by a majority vote. The empty seat will then be filled through the appointment process.

(11) The IRC may choose to request a recommendation from an NRHA Committee prior to determining the advancement or rejection of any case.

(12) If the IRC recommends a hearing, the IRC may also submit a sealed, confidential recommendation for discipline to be opened only in the event there is a hearing and the Hearing Body has determined that disciplinary action is warranted.

(13) In the event the IRC decides that this matter is to be forwarded to the Hearing Body, the manager of the IRC may, after consultation with NRHA President, Commissioner and Legal Counsel, obtain authority to offer the accused the IRC's recommended sanctions. Should the accused verbally accept the sanctions, a written finding and acceptance letter will be forwarded to the accused to be signed and returned at which time the sanctions will become effective immediately as if the Hearing Body had heard the matter and the protest shall be considered final.

Section 6. Hearing Body.

(1) The Hearing Body shall consist of five (5) members and be composed of two (2) members of the Board of Directors and three (3) nominated external NRHA members in good standing.

(2) The nomination of prospective members of the Hearing Body will be the responsibility of the NRHA Executive Committee. The final approval of those nominees will be the responsibility of the NRHA Board of Directors. Once the nomination and approval process is complete the Hearing Body shall function independently of the nomination and approving bodies.

(3) The term of office of a member of the Hearing Body shall be two (2) years.

(4) No term limitations apply and a current member of the Hearing Body may be re-nominated.

(5) For the first year of nominations one (1) member of the Board of Directors and two (2) NRHA members will be elected for a one (1) year term, the remaining one (1) Board of Director member and one (1) NRHA member shall be nominated for a two (2) year term.

(6) In the event that a member of the Hearing Body (for any reason) has not finished a term, the nomination and approval process will provide an individual to fulfill the remainder of that term.

(7) The NRHA Board of Directors may remove any member of the Hearing Body at any time for any reason by a majority vote. The empty seat will then be filled through the nomination and approval process.

(8) The Hearing Body shall be responsible for the conduct of all disciplinary activity involving members of NRHA.

(9) The decision and action of the Hearing Body shall be final and binding upon all parties, however, any aggrieved party to any protest may appeal the decision of the Hearing Body upon the notification and payment of a \$500 fee to the NRHA within ten (10) days (postmark) of the announcement by the Hearing Body of its decision.

(10) The appeal will be reviewed by the Executive Committee of NRHA and will either be supported or overturned by that body. If a member of the Executive Committee is elected to serve on the IRC or Hearing Body, they will not be allowed to participate in the appeal process.

(11) In the case that members of the Executive Committee are involved in the investigation, the Board of Directors shall have the right to appoint members to fill their vacancy during the appeal process.

(12) The makeup of the Hearing Body will be confidential. All evidence pertaining to a case, all testimony in the hearing and all Hearing Body member deliberations will be confidential

Section 7. Hearing Procedures.

(1) All disciplinary hearings shall be held at the principal office of the NRHA, or any other location as determined by the Hearing Body.

(2) In the absence of the physical presence of a sufficient number of members of the Hearing Body to constitute a quorum, a telephonic conference call may be used in order to achieve a quorum.

(3) In the event a quorum cannot be achieved in order to hear a disciplinary matter, the accused may elect to continue with the disciplinary hearing with less than a quorum or delay the matter until a quorum is achieved.

(4) In the event the accused does not elect to continue with the disciplinary hearing with less than a quorum or a quorum cannot be achieved because of disqualifications or recusal by Hearing Body members, the President shall appoint additional members from the Board of Directors to hear the disciplinary matter.

(5) All parties shall have the opportunity to appear in person at the hearing, with or without counsel, and to be heard and to present evidence and testimony on his or her own behalf and to hear and refute any evidence offered against him/her or entity. Should the accused choose to appear at the hearing, the accused does so at his or her own expense. Additionally, any costs associated with counsel for the accused shall be borne by the accused, regardless of the outcome of the hearing. The parties will receive a decision from the Hearing Body immediately after deliberation.

(6) Proceedings before the Hearing Body shall be informal, and rules of evidence, both at common law or provided by Oklahoma rules of civil or criminal evidence, need not be strictly observed. The standard by which admissibility is determined is whether the evidence is such that an ordinary

prudent person is willing to rely upon it. As an NRHA member or a person appearing before the Hearing Body, the accused person agrees that all witnesses and participants in such hearing shall be immune from any civil liability whatsoever, including, but not limited to, libel, slander, invasion of privacy, defamation, or product of disparagement, for testimony given in the course of preparation for or at the hearing.

Section 8. Hearing Results. Except as provided elsewhere in these Rules and Regulations, in regard to any violation of NRHA rules and regulations by an individual, member, non-member, or entity, the Hearing Body shall impose at a minimum the following sanctions:

- (1) First Offense not less than thirty (30) days probation.
- (2) Second Offense not less than thirty (30) days suspension.
- (3) Third Offense not less than a one-year suspension.
 - (a) In the event the Hearing Body does not necessarily feel that there has been a violation of the *NRHA Handbook* but the Hearing Body feels the matter should be addressed, the Hearing Body is authorized to issue a letter of concern or reprimand to any party or parties. In addition to the minimum sanctions set forth above, the Hearing Body shall have jurisdiction to invoke additional sanctions, including but not limited to, revocation or denial of membership privileges, revocation of participation privileges in all NRHA approved events, denial of privilege of access or presence on the show grounds of an NRHA approved event, denial of privilege to advertise in NRHA's official publications and/or an assessment of a fine. In the case of a violation by a show committee, affiliate, similar organization, or by the NRHA itself, the Hearing Body may take such action as necessary to remedy the violation and where appropriate, discipline accordingly.
 - (b) In the event sanctions or other requirements are imposed and ordered by the Hearing Body, such as the return of prize money, prizes, trophies, etc., the sanctions shall continue beyond the original sanction period imposed and ordered by the Hearing Body so long as there is any unfulfilled or uncompleted requirement/sanction. In the event a sanction or requirement is unfulfilled or unsatisfied after sixty (60) days that person's membership shall be automatically revoked. After fulfilling all obligations, that person may re-apply for membership or other previously held privileges such as Judging, Steward, Show Secretary, Professionals and Non Pro privileges subject to approval by the NRHA Executive Committee.
 - (c) When a member is disciplined, the order of the Hearing Body will be presented to the NRHA Board of Directors. The NRHA has the right to publish the name of any member or non-member (not current) in the appropriate disciplinary list.

Section 9. Legal Actions. Every member, former member, and non-member, including any corporation, LLC, partnership, trust, estate, or other legal entity that may be subject to these rules at any time, agrees that he, she, or such entity will not commence any action, whether in law or equity, against the NRHA in any courts other than those federal and state courts located in Oklahoma County, Oklahoma. If unsuccessful in any attempt to overturn any NRHA decisions, actions, rules or regulations, said person or entity agrees to reimburse NRHA for its reasonable attorney fees, court costs and other expenses in connection with the defense of such suit.

E. CAUSES FOR DISCIPLINARY ACTIONS

Section 1. Non Pro Violations.

(1) A Non Pro member of the Association shall follow the Non Pro Conditions at set forth in the *NRHA Handbook*.

(2) Non Pro Violations must be submitted within **two years** of the actual incident and must be submitted through the NRHA Protest procedures. See Disciplinary Procedure.

Section 2. Judge Violations.

(1) The IRC may choose to request an Investigative Judges Review (IJR), prior to determining the advancement or rejection of any case.

Section 3. Abuse.

(1) A member of the Association shall not abuse or mistreat any horse in any manner whatsoever on the show grounds. Abuse is defined as an action, or failure to act, which a reasonably prudent person, informed and experienced in the customs, accepted training techniques and exhibition procedures, would determine to be cruel, abusive, inhumane or detrimental to the horse's health.

(2) Individuals will be subject to the disciplinary procedures if it is determined that there was a willful abuse of the horse.

Section 4. Unsportsmanlike Conduct.

(1) Unsportsmanlike conduct will not be tolerated. Unsportsmanlike conduct shall be defined as any action of disrespect, deceit or fraud directed to judges, show management, show representatives, show stewards the NRHA, NRHA members or other exhibitors.

(2) Unsportsmanlike conduct shall also include failure to respond to any reasonable request by the NRHA, including failure to respond to disciplinary investigation inquiries.

F. CAUSES FOR DISCIPLINARY ACTION (PROTEST OR COMPLAINT NOT REQUIRED)

Section 1. Forfeitures. Any rider participating in a class or division in which he/she (or the horse he/she is riding) is not eligible. See Show Conditions.

Section 2. Failure to pay.

(1) Any member, non-member, approved Event, NRHA Affiliate

thereof, may be suspended and denied privileges of the NRHA for failure to pay when due, any obligation owed to:

- (a) NRHA;
- (b) RHSF;
- (c) *NRHA Reiner* magazine
- (d) An NRHA Approved Event; or
- (e) An NRHA recognized affiliate.

(2) Obligations owed to under these provisions to NRHA-approved Events and Affiliates, including but is not limited to: entry fees, stall fees, office charges, all costs and fees associated with a returned check, or any other fees or charges connected with the exhibition of reining horses are also subject to these provisions. This rule shall apply to the rider, owner, or agent for any unpaid debts related to the entry, exhibition, showing, stalling, or any related fee at an NRHA Approved Event. Agent is defined as anyone who acts and/or signs on the behalf of an owner or rider.

(3) Fifteen (15) days prior to suspension or denial of privileges pursuant to this section, NRHA will provide written notification of the amount due and the intention to suspend or deny privileges. See Reinstatement Guidelines for reinstatement procedures.

Section 3. Court of law convictions. When knowledge is gained of a conviction of an individual of a felony, animal abuse or moral turpitude under municipal, county, state or federal law, whether or not the NRHA is involved, the NRHA may subject the convicted person to discipline under the terms set forth in Article E. Any discipline imposed will be stayed pending completion of any statutory appeals. Acceptance of a conviction by NRHA will be given after notice to the sanctioned individual or entity, who may request a hearing before the NRHA Hearing Body to present lack of due process by the convicting court of law to merit NRHA's refusal to impose discipline.

Section 4. Convictions by other equine organizations. NRHA Executive Committee may accept **disciplinary** rulings pertaining to cruel or inhumane treatment and medication violations of horses from other recognized equine related associations, states, provinces or countries. The effect of such acceptance is to suspend the individual from NRHA membership privilege, or for non-members, to deny membership privileges, for a length of time equal to the suspension for which reciprocity is given. Acceptance of such rulings by NRHA will be given after notice to the sanctioned individual or entity, who may request a hearing before the NRHA Executive Committee to present lack of due process by the reporting association to merit NRHA's refusal to give reciprocity.

Section 5. Failure to comply with suspension. In the event a member suspended for any reason enters a horse as an owner or rider at any NRHA approved event during the period

of suspension either as owner, rider, agent or entity, the NRHA will automatically impose an additional six (6) month period of suspension and all show prizes and awards will be forfeited to the NRHA as per the *NRHA Handbook*.

Section 6. Other.

(1) If the Hearing Body deems the submission of a protest to be malicious and/or frivolous, appropriate disciplinary action may be taken.

(2) Any member interfering with or attempting to influence the outcome of a protest investigation or hearing may be subject to disciplinary action by the NRHA.

Section 7. Reinstatement Guidelines.

(1) Must pay all obligations as a result of failure to pay or any other fines assessed by the NRHA.

(2) Members who are suspended for any reason must pay the association a \$100 fee to reinstate their membership.

(3) Members who have received disciplinary action and/or suspension will lose privileges (Professionals, Non Pro, Judges, etc.) for the duration of the disciplined period.

(4) All disciplined and/or suspended members must reapply to regain privileges (Professionals, Non Pro, Judges, Show Secretaries, Stewards, etc.) once the duration of the disciplined period is concluded. To reapply, the member must request in writing to the NRHA Executive Committee. The Executive Committee shall have the right to request a recommendation from an NRHA Committee prior to making a decision.

(5) Once re-instated, the member shall be eligible for the same divisions as previous to the suspension, pending the eligibility criteria did not change during the length of the disciplinary action and/or suspension time period.

G. Animal Welfare and Medications Provisions Applicable to all NRHA Events.

It is not NRHA's intention to conflict with rules and regulations of states, provinces or countries in regards to medications. In cases, where NRHA shows are held in states, provinces or countries with medications rules and regulations, the rules and regulations of the state, province or country take precedence.

Section 1. Testing

(a) All horses entered in an NRHA approved class that meet the criteria of the NRHA Animal Welfare and Medications Policies are subject to examination by a licensed veterinarian who must be approved by NRHA. Said approved veterinarian may appoint a technician to perform certain duties under this rule. The examination may include physical, urine, blood tests and/or any other test or procedure at the discretion of said veterinarian necessary to effectuate the purposes of this rule.

(b) Persons responsible for a horse being tested who are not able to accompany NRHA drug testing personnel and the horse to the location where sample collection

is to take place, to act as witness to the collection and sealing of blood and urine samples, and to sign the drug collection documents in the appropriate places as witness, must appoint an agent to do so. The absence of such a witness shall constitute a waiver of any objection to the identification of the horse tested and the manner of collection and sealing of the samples.

(c) Upon the collection of a sufficient number of tubes of blood from the horse, the tubes shall be divided into two groups. One group shall be labeled and identified as Blood Sample A, and the other as Blood Sample B, and they shall be sealed accordingly. Upon the collection of a sufficient volume of urine from the horse, a portion of the sample shall be poured into a second urine sample container. One container shall be labeled and identified as Urine Sample A, and the other as Urine Sample B, and they shall be sealed accordingly. These procedures shall be performed whether or not the person responsible or his/her appointed witness is present as provided for in Section 1(b) above.

(d) In the event reasonable attempts at sample collections from the horse do not provide a sufficient number of tubes of blood or a sufficient volume of urine to be divided, labeled, and identified as Samples A and B, as determined by the testing veterinarian and/or technician, the sample(s) obtained (if obtained) shall be labeled and identified as Sample(s) A only, and it shall be recorded in the records of the Animal Welfare and Medications Program that the corresponding Sample(s) B does (do) not exist, in which event the obtained Sample(s) shall be subject to testing.

Section 2. Cooperation

(a) Cooperation with the veterinarian and/or his agent(s) includes:

- i. Taking the horse and the veterinarian and/or his agent(s) immediately to the location selected by said veterinarian and/or agent(s) for testing the horse and presenting it for testing.
- ii. Assisting the veterinarian and/or his agent(s) in procuring the sample promptly, including but not limited to removing equipment from the horse, leaving it quietly in the stall and avoiding any distractions to it. Schooling, lengthy cooling out, bandaging and other delays of this type shall be construed as noncooperation.

Section 3. Responsibility and Accountability of Person(s) Responsible

(a) A person responsible is defined as any adult or adults who has or shares the responsibility for the care, training, custody, condition, or performance of a horse whether said person be a trainer, owner, rider, agent and/or coach. Where a minor exhibitor has no person responsible, then a parent, guardian or agent or representative thereof assumes responsibility.

(b) The person(s) responsible in the absence of substantial evidence to the contrary are responsible and accountable under the penalty provisions of these rules:

i. for the condition of a horse at an NRHA approved event and

ii. to know all of the provisions of General Rules and Regulations (G) (including any advisories or interpretations published in the *NRHA Reiner*) and all other rules and regulations of the NRHA and the penalty provisions of said rules. For purposes of this rule, substantial evidence means affirmative evidence of such a clear and definite nature as to establish that said person responsible, or any employee or agent of the person responsible, was, in fact, not responsible or accountable for the condition of the horse. If any person responsible is prevented from performing his or her duties, including responsibility for the condition of the horses in his or her care, by illness or other cause, or is absent from any NRHA approved event where horses under his or her care are entered and stabled, he or she must immediately notify the event secretary and, at the same time, a substitute must be appointed by the person responsible and such substitute must place his or her name on the entry blank forthwith. Such substitution does not relieve the regular person responsible of his/her responsibility and accountability under this rule; however, the substitute person responsible is equally responsible and accountable for the condition of such horses.

(c) The person responsible and owner acknowledge that the person responsible represents the owner regarding horses being trained or managed, entries, scratches for any reason and any act performed on any horse under the care and custody of the person responsible.

(d) In the case of a horse competing under the Therapeutic Substance Provisions, any person responsible or other person subject to these rules who actually administers, attempts to administer, instructs, aids, conspires with another to administer or employs anyone who administers or attempts to administer a forbidden substance to a horse which might affect the performance of said horse at an event licensed by the NRHA without complying with Section 8, is subject to the penalties provided in Section 5, and General Rules and Regulations (E) and the Animal Welfare and Medications Policies.

(e) Any person(s) responsible or person subject to these rules who administers, attempts to administer, instructs, aids, conspires with another to administer or employs anyone who administers or attempts to administer any substance to a horse by injection or by any other route of administration, whether the substance is forbidden or permitted, at an event licensed by the NRHA, whether it be during a scheduled class in the competition ring, prac-

tice arenas, alleys leading into the arenas or any other public areas of the show grounds, is subject to the penalties provided in Section 5.

(f) Unless administered in a life-saving situation which should be done based on consultation with a veterinarian.

Section 4. Results, Confirmatory Analysis, and Retest

(a) Blood and urine samples labeled and identified as Samples A shall be subjected to chemical analysis by a laboratory with which NRHA has contracted for its services. Blood and urine samples labeled and identified as Samples B shall be stored securely, unopened, at the contracted laboratory, to be used in the event that a confirmatory analysis shall be required.

(b) In the event the chemical analysis of Blood or Urine Sample A is negative, i.e., no forbidden substance or any metabolite or analogue thereof is found to be present in the sample, the corresponding Blood or Urine Sample B shall be destroyed by the laboratory.

(c) In the event the chemical analysis of Blood or Urine Sample A is positive, i.e., a forbidden substance or any metabolite or analogue thereof is found to be present in the sample, this shall be prima facie evidence that the forbidden substance was administered in some manner to said horse, whether intentionally or unintentionally, or otherwise was caused to be present in the tissues, body fluids or excreta of the horse at the event, whether intentionally or unintentionally, such that the person(s) responsible deemed responsible and accountable for its condition is (are) liable under the provisions of Section 3.

(d) In the event the chemical analysis of Blood or Urine Sample A is positive, and upon the issuance of Notices of Charge to persons deemed responsible and accountable under the rules, a person charged who requests a confirmatory analysis of the corresponding Blood or Urine Sample B must make the request in writing to NRHA Counsel, and it must be received within 15 days of the date of the Notice of Charge.

(e) The confirmatory analysis of the corresponding Blood or Urine Sample B shall be performed by a drug testing laboratory that must be mutually agreed upon by the person charged who requests the confirmatory analysis and NRHA Counsel, which laboratory must have demonstrated proficiency in performing the necessary confirmatory analysis, provided the corresponding Blood or Urine Sample B exists and is of sufficient volume to permit a confirmatory analysis. In the event the drug testing laboratory that analyzed Sample A is the only laboratory that has demonstrated proficiency in performing the necessary confirmatory analysis, as determined by NRHA Counsel, this laboratory shall be the only laboratory to which NRHA Counsel shall agree to perform the confirmatory analysis of the corresponding Sample B. Upon the completion of the confirmatory analysis, the laboratory performing the confirmatory analysis shall

forward its findings and supporting data to all parties.

(f) In the event no agreement is reached as to a laboratory as required in Section 4(e) above, and the person charged who requests the confirmatory analysis does not revoke his/her request, the confirmatory analysis of the corresponding Blood or Urine Sample B shall be performed by the contracted laboratory as determined by NRHA Counsel, which laboratory shall forward its findings and supporting data to all parties. Both the results of the analysis of Sample A (and supporting data) and the results of the confirmatory analysis of the corresponding Sample B, if any (and supporting data, if any), shall be admissible as evidence in any hearing or proceeding pertaining to this matter.

(g) In the event the corresponding Blood or Urine Sample B does not exist, or is of insufficient volume to permit a confirmatory analysis, as determined by NRHA Counsel, and there exists a remaining aliquot of Blood or Urine Sample A which is of sufficient volume to permit a retest, as determined by NRHA Counsel, a person charged who requests the retest of Blood or Urine Sample A must make the request in writing to NRHA Counsel, and it must be received within 7 days of the determination that the corresponding Blood or Urine Sample B does not exist or is of insufficient volume to permit a confirmatory analysis.

(h) Any requested re-test of the remaining aliquot of Blood or Urine Sample A, provided it is of sufficient volume to permit a retest, shall be performed by the contracted laboratory as determined by NRHA Counsel.

(i) The retest of the remaining aliquot of Blood or Urine Sample A may be witnessed by a Witnessing Analyst appointed by the person charged who requests such analysis at the same time as the retest is requested. The Witnessing Analyst must be a qualified analytical chemist employed by an equine drug testing laboratory. If no Witnessing Analyst is appointed by the person requesting the retest, or if the Witnessing Analyst is unavailable within a reasonable time, the requested retest of the remaining aliquot of Blood or Urine Sample A shall proceed without the Witnessing Analyst.

(j) In the event the Witnessing Analyst appointed by the person requesting the retest of the remaining aliquot of Blood or Urine Sample A is satisfied that the positive result is correct, NRHA Counsel must be informed immediately by fax with confirmation by letter.

(k) In the event the Witnessing Analyst is not satisfied that the result of the retest of the remaining aliquot of Blood or Urine Sample A is correct, NRHA Counsel must be informed immediately by fax followed by a written report setting forth the basis for the Witnessing Analyst's opinion. Copies of the original and subsequent results and supporting analytical data must be submitted to the NRHA Hearing Body as part of the hearing record in the case,

for resolution by it of any and all issues regarding the original analysis of Blood or Urine Sample A and the retest of the remaining aliquot of Blood or Urine Sample A.

(l) By requesting the confirmatory analysis of the corresponding Blood or Urine Sample B, or the retest of the remaining aliquot of Blood or Urine Sample A, or by requesting that the retest be witnessed by a Witnessing Analyst, the person charged who makes such request(s) agrees to and must pay any and all fees, costs and expenses relating to the confirmatory analysis or the retest, whether it is performed by a mutually agreed upon laboratory, by the contracted laboratory upon the presentation of an invoice by NRHA Counsel, and any and all fees, costs, and expenses relating to the Witnessing Analyst.

(m) If the chemical analysis of the sample taken from such horse indicates the presence of a forbidden substance or any metabolite or analogue thereof and all the requirements of Section 8 have been fully complied with, the information contained in said Medications Report Form and any other relevant evidence will be considered by NRHA in determining whether a rule violation was committed by any person(s) responsible or accountable for the condition of the horse under the provisions of this rule.

(n) When a positive report is received from the chemist identifying a forbidden substance, or any metabolite or analogue thereof, a hearing will be held in accordance with General Rules and Regulations (D) and the Animal Welfare and Medications Policies. No person responsible or accountable for the condition of said horse, will be suspended, or a horse barred from competition, until after an administrative penalty has been assessed or after the conclusion of a hearing and a written ruling thereon has been made.

(o) The owner or owners of a horse found to contain a forbidden substance or any metabolite or analogue thereof may be required to forfeit all prize money, sweepstakes, added money and any trophies, ribbons and "points" won at said event by said horse and the same will be redistributed accordingly. If, prior to or at a hearing, NRHA as the charging party, determines that one or more persons, not previously charged as a person responsible should also be charged as a person responsible, then, upon application by NRHA, the Hearing Body may, in its discretion, continue or adjourn the hearing, in whole or in part, to permit a new or amended charge to be issued (unless the person(s) to be charged waive notice).

(p) A person responsible of a horse found to contain such forbidden substance or any metabolite or analogue thereof is subject to whatever penalty is assessed by the Hearing Body, as provided by General Rules and Regulations (D) and the Animal Welfare and Medications Policies. Said person responsible may be fined and may

be suspended from all participation in NRHA approved events as outlined in General Rules and Regulations (D) Section 8 and the Animal Welfare and Medications Policies. In determining an appropriate penalty under these rules, the Hearing Body may take into account such factors and circumstances as it may deem relevant, including but not limited to:

- i. the pharmacology of the forbidden substance,
- ii. the credibility and good faith of the person charged or of other witnesses,
- iii. penalties determined in similar cases, and
- iv. past violations of any NRHA rules (or the lack thereof).
- v. reliance upon the professional ability or advice of a veterinarian who is a licensed graduate of an accredited veterinary school and who is in good standing in the state, province or country in which he/she primarily practices.

Section 5. Management Procedures

(a) Testing fees will be applied where testing is carried out at NRHA events as approved by the NRHA Board of Directors.

(b) Event management must cooperate with the veterinarian and/or his agents.

Section 6. Interpretations of the NRHA Animal Welfare and Medications Rule and its Application to Particular Substances.

Trainers, persons responsible and/or owners who seek advice concerning the interpretation and application of this rule should not rely solely upon interpretations or advice by private or event veterinarians, event officials, event personnel, or other persons, but should also obtain verification of any such interpretations or advice from the NRHA Animal Welfare and Medications Program office. Any trainer, person responsible or owner who is uncertain about whether this rule applies in any given situation would be well advised to withdraw the affected horse from competition until such time as the NRHA Animal Welfare and Medications Program office has been consulted.

Section 7. Equine Medications, The Therapeutic Substance Provisions

(a) No horse competing in an event approved by NRHA is to be shown in any class (see also Section 1 (a), last sentence) if it has been administered in any manner or otherwise contains in its tissues, body fluids or excreta a forbidden substance except as provided in Section 8.

For purposes of this rule, a forbidden substance is:

- i. Any stimulant, depressant, tranquilizer, local anesthetic, psychotropic (mood and/or behavior altering) substance, or drug which might affect the performance of a horse (stimulants and/or depressants are defined as substances which stimulate or depress the cardiovascular, respiratory or central nervous systems), or any metabolite and/or analogue of any such substance or drug, except as expressly permitted by this rule.

- ii. Any corticosteroid present in the plasma of the horse other than dexamethasone (see Section (e)(ii)).
- iii. Any nonsteroidal anti-inflammatory drug in excess of two present in the plasma or urine of the horse (Section 8 does not apply); exception: salicylic acid and topical use of diclofenac (Surpass) is permitted in addition to two additional nonsteroidal anti-inflammatory drugs.
- iv. Any substance (or metabolite and/or analogue thereof) permitted by this rule in excess of the maximum limit or other restrictions prescribed herein.
- v. Any substance (or metabolite and/or analogue thereof), regardless of how harmless or innocuous it might be, which might interfere with the detection of any of the substances defined in (i), (ii), (iii) or (v) or quantification of substances permitted by this rule.
- vi. Any anabolic steroid.

(b) EXHIBITORS, OWNERS, TRAINERS, PERSONS RESPONSIBLE AND VETERINARIANS ARE CAUTIONED AGAINST THE USE OF MEDICINAL PREPARATIONS, TONICS, PASTES, AND PRODUCTS OF ANY KIND, THE INGREDIENTS AND QUANTITATIVE ANALYSIS OF WHICH ARE NOT SPECIFICALLY KNOWN, AS MANY OF THEM MAY CONTAIN A FORBIDDEN SUBSTANCE.

(c) The full use of modern therapeutic measures for the improvement and protection of the health of the horse is permitted unless:

- i. The substance administered is a stimulant, depressant, tranquilizer, local anesthetic, drug or drug metabolite which might affect the performance of a horse or might interfere with the detection of forbidden substances or quantification of permitted substances; or
- ii. More than two nonsteroidal anti-inflammatory drugs are present in the plasma or urine of the horse (Section 8 does not apply); exception: salicylic acid and topical use of diclofenac (Surpass) is permitted in addition to two additional nonsteroidal anti-inflammatory drugs; or
- iii. The presence of such substance in the blood or urine sample exceeds the maximum limit or other restrictions prescribed herein below.

(d) Restrictions concerning the nonsteroidal anti-inflammatory drugs are as follows:

- i. The maximum permitted plasma concentration of diclofenac is 0.005 micrograms per milliliter.
- ii. The maximum permitted plasma concentration of phenylbutazone is 15.0 micrograms per milliliter.
- iii. The maximum permitted plasma concentration of flunixin is 1.0 micrograms per milliliter.
- iv. The maximum permitted plasma concentration of ketoprofen is 0.250 micrograms per milliliter.
- v. The maximum permitted plasma concentration of meclofenamic acid is 2.5 micrograms per milliliter.
- vi. The maximum permitted plasma concentration

of naproxen is 40.0 micrograms per milliliter.

vii. The maximum permitted plasma concentration of firocoxib is 0.240 micrograms per milliliter.

viii. Upon the approval of eltenac by the FDA, the maximum permitted plasma concentration of eltenac is 0.1 micrograms per milliliter.

ix. A maximum of two substances listed in (i) through (vii) above are permitted to be present in the same plasma or urine sample (Section 8 does not apply); exception topical use of diclofenac (Surpass) is permitted in addition to two additional nonsteroidal anti-inflammatory drugs.

x. Phenylbutazone and flunixin are not permitted to be present in the same plasma or urine sample (Section 8.a.xi. does not apply).

xi. Any nonsteroidal anti-inflammatory drug not listed in (i) through (vii) above is forbidden to be present in the plasma or urine sample (Section 8 does not apply); exception: salicylic acid.

xii. Any nonsteroidal anti-inflammatory drug that becomes approved for use in horses can be added to the list of those permitted, after the completion, review and approval of the needed research.

(e) Restrictions concerning other therapeutic substances are as follows:

i. The maximum permissible plasma concentration of methocarbamol is 4.0 micrograms per milliliter.

ii. The maximum permitted plasma concentration of dexamethasone is 0.003 micrograms per milliliter.

(f) Thresholds for substances of possible dietary origin are as follows:

i. The maximum permissible urine concentration of theobromine is 2.0 micrograms per milliliter.

Section 8. Conditions for Therapeutic

Administrations of Forbidden Substances

(a) A horse exhibiting at an NRHA approved event pursuant to the Therapeutic Substance Provisions that receives any medication which contains a forbidden substance is not eligible for competition unless all of the following requirements have been met and the facts are furnished in writing on a timely-submitted official Medications Report Form:

i. The medication must be therapeutic and necessary for the diagnosis or treatment of an existing illness or injury. Any person responsible who is uncertain about whether a particular purpose is considered to be therapeutic would be well advised to consult his/her veterinarian or testing laboratory.

ii. The horse must be withdrawn from competition for a period of not less than 24 hours after the medication is administered.

iii. The medication must be administered by a licensed veterinarian in good standing, or, if a veterinarian is unavailable, only by the trainer/person

responsible pursuant to the advice and direction of a veterinarian.

iv. Administration of a forbidden substance for non-therapeutic or optional purposes (such as, by way of example only, shipping, clipping, training, turning out, routine floating or cleaning of teeth, non-diagnostic nerve blocking, uncasting, mane pulling or non-emergency shoeing) is not considered to be therapeutic. Medications are permissible if administered prior to 24 hours prior to competition and is declared on a timely-submitted official Medications Report Form. (see Animal Welfare and Medications Policies for details on permissible therapeutic medications).

v. Identification of medication—the amount, strength and route of administration.

vi. Date and time of administration.

vii. Identification of horse, its name, age, sex, color and entry number.

viii. Diagnosis and reason for administration.

ix. Statement signed by person administering medication.

x. Medications Report Form filed with the Show Steward or Show Representative within one hour after administration or one hour after the Show Steward or Show Representative returns to duty after competition resumes if administration is at a time other than during competition hours.

xi. The Show Steward or Show Representative must sign and record the time of receipt on the Medications Report Form.

xii. Flunixin (Banamine) is a quantitatively restricted medication that may be used conditionally as a third NSAID and/or in addition to phenylbutazone to treat colic or ophthalmic emergencies only under the actual observation of event management (or designated representative) and/or official event veterinarian, either of which must sign the medication report form, to aid in instances of colic. A Medications Report Form must be filed with event management as required in this rule.

xiii. Lidocaine/Mepivacaine: Is a conditionally permitted medication that may only be used within 24 hours of competition under actual observation of event management (or designated representative) and/or the official event veterinarian, either of which must sign the medication report form, to aid in the surgical repair of minor skin lacerations which, due to their very nature, would not prevent the horse from competing following surgery. Treatments include, but are not limited to, repair of heel bulb. A Medication Report Form must be filed with the event management as required in this rule.

(b) Where all the requirements of Section 8 have been

fully complied with, the information contained in said Medications Report Form and any other relevant evidence will be considered by the NRHA in determining whether a rule violation was committed by any person(s) responsible or accountable for the condition of the horse under the provisions of this rule.

NOTE: The official Medications Report Form is available from the officiating Show Steward, Show Representative and/or Show Secretary. All required information must be included when filing a report. Failure to satisfy and follow all the requirements of this Rule and to supply all of the information required by such Medications Report Form is a violation of the rules. The Show Steward/Show Representative must report any known violations of this Rule to the NRHA for such further action as may be deemed appropriate.

SHOW RULES AND REGULATIONS

A. MEMBERSHIP

(1) All riders and owners (including business entities) of horses showing in NRHA approved competition must be members in good standing. Every member is issued a membership card with an ID#. This number must be used in all official communication with NRHA, and the card (or a photocopy) must also be shown to the entry secretary when entering NRHA approved classes. Renewals and new memberships can be applied for at any NRHA approved show. A temporary card will be issued which is good for forty five (45) days from issue. Entry forms must identify the horse with the correct competition license number, the rider with the correct and current membership number, and the owner or owners with the correct and current membership numbers to identify the ownership entity as recognized in the NRHA database. Any deviation from the above information may affect earnings for Top Ten purposes. It is the responsibility of riders and owners to be aware of and abide by all the rules and regulations set forth in this *NRHA Handbook*. Any person or entity in violation of NRHA rules may be subject to, but not limited to, fines, forfeitures, probation and/or disciplinary procedures.

(a) **Memberships:** (For countries participating in the International Affiliate Program, total membership fees may vary.)

Associate, Associate Non Pro and Associate Youth members are only eligible to show in Category 10 classes and do not receive a printed copy of the *NRHA Reiner*, do not have voting privileges, and do not fulfill the ownership requirement for licensing a horse except for Category 10 classes. Associate members may not serve as NRHA show officials (show secretary, steward, representative, judge, etc.)

NRHA memberships, Non Pro Declarations, and/or NRHA Professionals applications, including the *NRHA Reiner*, commence when the membership is received. Memberships and *NRHA Reiner* subscriptions are not retroactive.

Life Memberships When a Life member becomes deceased, the membership will end on December 31 of the current year. This will allow for any horses that may be currently shown under the membership to continue to do so for Top Ten purposes or otherwise.

NRHA memberships, Non Pro Declarations and/or NRHA Professionals Applications received with show results will be made effective the first date of the respective show.

Memberships paid at shows: If a member attends a show without proof of current membership, he/she will be required to complete an NRHA membership application and/or Non Pro Declaration and pay the membership fee before entering.

If the member previously applied through the NRHA office or at a show NRHA will refund the second membership if it is paid within thirty (30) days of the first membership. If it is paid after thirty (30) days, there will be no refund and NRHA retains the money.

Annual and Three Year memberships end December 31. The first issue of the *NRHA Reiner* will be received in 6–8 weeks after the membership is received by NRHA.

Non Pro A Non Pro Declaration and one-time fee must accompany membership application, unless already on file at the NRHA office. Non Pro Declarations can be applied for and submitted at any NRHA approved show. (If a Non Pro membership has lapsed for more than one calendar year, the applicant will be required to re-file a Non Pro Declaration, including the fee.)

Youth Non Pro A Non Pro Declaration and one-time fee must accompany membership application, unless already on file at the NRHA office. (If a Youth Non Pro membership has lapsed for more than one calendar year, the applicant will be required to re-file a Non Pro Declaration, including the fee.)

(b) NRHA Reiner Magazine Subscription and Postage Fees

USA: May elect to receive the *NRHA Reiner* (printed version), one (1) per address. Associate and youth members may purchase a *Reiner* subscription at the Member price (see NRHA Fee Schedule policy). The Digital version of the *NRHA Reiner* is available on the NRHA website, nrha.com, free of charge to all.

International: May elect to receive the *NRHA Reiner* (printed version). Associate and youth members may purchase a *Reiner* subscription at the Member price (see NRHA Fee Schedule policy). For delivery of the *NRHA Reiner* (print version) outside of the U.S.A, additional postage is required (see NRHA Fee Schedule policy).

(2) Owners must join NRHA either jointly or individually if competition licenses list dual or joint ownership using and, or, and/or, or simply commas. However, if either party intends to compete in NRHA events, they must have separate memberships since ALL RIDERS MUST HAVE INDIVIDUAL MEMBERSHIPS to track earnings. Only individual NRHA General members are eligible to vote.

(3) NRHA cannot be responsible for any payments or paperwork not received in the NRHA office. It is recommended that any time-sensitive materials be sent to the NRHA office by guaranteed delivery.

B. NON PRO CONDITIONS

(1) Eligibility:

(a) A Non Pro is defined as a person who, at the time of application, has not won in excess of \$100,000 (one hundred

thousand dollars) in Category 1, 2 and 6 in open reining competition and who has not received direct (money) or indirect (goods or services) remuneration for:

(1) training astride or showing astride in any equine discipline.

(2) giving instruction on showing or training of a performance horse (Reining, Cutting, Cow Horse).

(3) sponsorships or endorsements unless approved by the Executive Committee due to celebrity status gained outside the reining industry.

(b) Ineligible persons desiring to obtain Non Pro status may do so after meeting all Non Pro requirements for a period of time equal to the number of years they have not met the Non Pro requirements with a minimum of three (3) years and a maximum of five (5) years.

(1) During the ineligible time period, the member may show only in NRHA Open competition.

(2) After obtaining Non Pro status, the member shall be eligible for any classes based on their current eligibility.

(c) A Non Pro who gives up his/her Non Pro status, and becomes an open rider must complete and submit the Non Pro Relinquishment Form within thirty (30) days of the change. Non Pro earnings in any category/class will not be utilized in determining current eligibility, with the exception of the Category 2 or 6 Level 1 Open and Rookie Professional class.

(2) Application Process:

(a) An applicant must complete the official NRHA Non Pro Declaration, and submit it to the NRHA office with the appropriate fee.

(b) Persons applying for Non Pro status must answer all questions on the Non Pro Declaration, agree to abide by the Non Pro Code of Conduct and Ethics, and sign the Non Pro Declaration affirming the truth of all statements given as well as acceptance of the rules and regulations relating to NRHA Non Pro membership.

(c) An applicant must complete a Non Pro Declaration prior to entering a Non Pro class. Non Pro status will be granted on a temporary basis and is subject to revocation and forfeiture of earnings and prizes pending publication in the *NRHA Reiner*.

(d) Once Non Pro status is granted, the Non Pro does not have to resubmit the Non Pro Declaration unless there is a change to their eligibility or if their NRHA membership lapses for more than one calendar year.

(3) Showing:

(a) A horse shown in Non Pro competition must be solely and completely owned by one of the following:

(1) the Non Pro,

(2) a member or members of his/her immediate family

(3) a corporation, partnership, or other business entity

provided that the Non Pro and/or a member or members of his/her immediate family are the sole and only owners of that business entity and the ownership of that business entity does not change to include non immediate family members or entities. Ownership will be evidenced by the competition license. See Competition Licensing section of the *Handbook*.

(b) Definition of immediate family: spouse, partner/mate, parent, spouse's parent, partner/mate's parent, step-parent, legal guardian, child, step-child, sibling, sibling's spouse, sibling's partner/mate, half sibling, step-sibling.

(1) For Non Pro riders under the age of 19, the definition also includes aunt, uncle, grandmother and grandfather.

(2) Determination of partner/mate status will only be accepted when the civil status is legally and lawfully registered in the country/state of residence. All relationships must be current and lawful.

(c) It is the responsibility of the Non Pro to file an Immediate Family Form with the NRHA prior to showing an immediate family member's horse. The Non Pro is also responsible for updating that form with any changes. If there is no Immediate Family Form on file with the NRHA office, a Non Pro may be forfeited out of any NRHA Non Pro classes in which they have shown.

(d) Payment of entry fees and/or expenses by anyone other than the Non Pro, his/her immediate family, or a corporation, partnership or other business entity in which the Non Pro and/or a member of his/her immediate family are the sole and only owner, shall be considered remuneration and could jeopardize Non Pro status.

(e) Any transaction relating to the sale or transfer of a horse to a Non Pro other than by immediate family members must be at fair market value. The Non Pro is responsible for documenting said transaction in a satisfactory fashion in the event of any protest.

(1) If a Non Pro and/or his/her immediate family member sells a horse and then buys it back, the Non Pro and/or his/her immediate family member cannot show that horse in Non Pro classes for 180 days from the time he/she originally sold the horse.

(f) A Non Pro is prohibited from showing in after-market logoed apparel or equipment.

(4) Allowances:

(a) A Non Pro can accept payment of entry fees and/or expenses for:

(1) demonstrations, exhibitions, or international competitions where the Non Pro is representing their National Federation.

(2) competitions where the Non Pro is representing their college or school as an individual or part of a team.

(3) demonstrations pre-approved by the NRHA Executive Committee.

(4) travel expenses from an NRHA Affiliate for exhibitors qualifying for NRHA Affiliate Championship competition.

See Adequan® North American Affiliate Program Conditions.

(b) Students enrolled in college/university equine programs may accept remuneration for giving lessons or training horses astride as part of an educational curriculum (e.g., internships, exchange programs) during the term of the curriculum. A Non Pro applicant excepted under this provision must have disclosed this information to the NRHA office. Students exempted under this provision may only show in Open competition during the term of the curriculum.

(c) A Non Pro may appear in reining industry advertisements as long as no remuneration, direct or indirect is received.

(d) An NRHyA member can be selected for any approved exchange program through the NRHyA. The selected NRHyA members shall not be in jeopardy of losing his/her Non Pro status through participation in approved exchange programs.

(e) A Non Pro applicant can be a certified instructor in a national equine equitherapy program (e.g. Professional Association of Therapeutic Horsemanship International [PATH Intl]). The excepted instructor shall only teach students enrolled with an approved organization or students prescribed such rehabilitation by a licensed medical doctor. A Non Pro applicant excepted under this provision must have disclosed this information on the Non Pro Declaration that is submitted to the NRHA office.

(5) Non Pro Investigation Procedures:

(a) A Non Pro card is a privilege and not a right.

(b) The Non Pro Committee may review all applicants and make a recommendation to the NRHA Board of Directors whose decision shall be final.

(c) Should a member wish to protest the eligibility of a Non Pro, he/she may file a protest with the NRHA office in accordance with the procedures set forth in the Disciplinary Procedure section.

(d) NRHA has the right to review details of any transaction relating to the sale of a horse. Included in the review shall be methods of procurement, all transfer records, cancelled checks and deposit slips.

(6) NRHA Apprentice Program:

(a) Non Pro Apprentice Exemption: Apprentice status must be granted prior to an applicant apprenticing with an NRHA Professional. Applicants must allow ninety (90) days minimum for processing applications. Individuals that begin Apprenticeship prior to Apprentice status being granted are in violation of the Non Pro conditions and their Non Pro status will be in jeopardy. Failure to comply with the application requirements as specified in this *Handbook* may result in disciplinary action.

(b) A Non Pro may participate in the Apprentice Program

only once. The Non Pro must complete an Apprentice Program Application.

(c) An Apprentice Program applicant may be subject to a personal interview with the Non Pro Committee.

(d) Apprentice status may be granted by the NRHA Board of Directors following the recommendation of the Non Pro Committee.

(e) The applicant must apprentice with a member of the NRHA Professionals and physically work at that Professional's facility.

(f) All NRHA previous Non Pro as well as Open earnings will be used to determine the Apprentice's class eligibility. The Apprentice can only show in Open division classes during the apprenticeship period.

(g) All applicants must be at least 18 years of age.

(h) There is no earnings limit.

(i) Apprenticeship is a twelve (12) month consecutive period. At the end of that time, the apprentice may remain an open rider. In this case, previous Non Pro earnings will be backed out for eligibility purposes. If the Apprentice does not remain an Open rider, the Apprentice must then reapply for Non Pro status and is subject to the Non Pro conditions. Any monies won during the 12 consecutive month Apprenticeship shall be applied to their Non Pro eligibility.

C. COMPETITION LICENSING

(1) Horses competing in NRHA approved competition may be required to have a competition license. Owners and co-owners must be current members of the NRHA prior to the horse being shown in any class except Category 10 classes. (see Show Rules and Regulations, A. Membership).

(2) Beginning January 1, 2002 a horse's registered breed name will be used as the NRHA competition name. Owners of non-registered horses may select a name, provided the name does not appear in the NRHA database prior to the date of application.

(3) For NRHA aged shows, the age of a horse shall be determined as follows:

(a) For horses foaled in the Northern Hemisphere, age will be determined by a calendar year starting January 1 of the year foaled. The horse is a weanling during the year foaled and a yearling during the following year.

(b) For horses foaled in the Southern Hemisphere, age will be determined one of two ways:

(1) Horses foaled July 1 through December 31 will be considered a weanling during the next calendar year after which it was foaled and a yearling during the subsequent year. (For example: a horse foaled in the Southern Hemisphere July 1, 2007–December 31, 2007 will be considered a weanling in 2008 and a yearling in 2009).

(2) Horses foaled in the Southern Hemisphere January 1 through June 30 will be considered a weanling during

the calendar year in which it was foaled and yearling during the following year.

(4) Competition licenses are permanent when issued to each horse and are not renewed each year. A fee will be charged for the original license, for replaced licenses, for transfers of ownership, and licenses requested by the owner to be reprinted for any reason (examples: person or horse name changes or gelding status). A photocopy of the horse's registration papers (or photographs of the front, back and each side in the case of unregistered horses) must be submitted with each license application. Applications are available at the NRHA office.

(5) In the case of a competition license transfer, it is the responsibility of the purchaser to obtain and submit all transfer paperwork and fees prior to the horse being shown. The transfer of or application for a competition license will be effective the date it is received in the NRHA Office or at an NRHA approved event and is not retroactive.

(6) The competition license will be returned to the recorded owner. The owner will be responsible for getting photocopies of the license to any person needing them for entry in any NRHA approved event.

(7) To enter NRHA approved competition, the competition license (original or photocopy) must be shown to the show secretary taking the entries when a competition license is required. All competition license applications and transfers of ownership must be completed prior to competing.

(8) If a horse is shown without correct ownership on the competition license the show secretary will be fined \$10 and the rider will be fined \$25. A second offense may result in the rider being disqualified and forfeited from the class and a \$200 fine.

(9) **Lost Competition Licenses:** Competition licenses that have been lost for any reason such as: lost in the mail, misplaced, destroyed, or not received from the previous owner, can be replaced by completing the Affidavit process and submitting the appropriate fee.

(10) Any misrepresentation or false statement on the license application shall constitute unsportsmanlike conduct and will subject owner and/or exhibitor to disciplinary action as set forth in the *NRHA Handbook*.

(11) When a horse is gelded, such fact must be reported to the NRHA office immediately. This must be done by providing the NRHA office the horse's original competition license and a statement from the owner of record indicating the date the horse was gelded. The NRHA office will make the appropriate notation on its records and on the competition license and return the license at no charge. If the owner requests the license be reprinted, fees will apply.

D. CATEGORIES OF COMPETITION AND CLASS ELIGIBILITY

Class Eligibility is based on the rider's and/or the horse's earnings as of January 1 of the current NRHA year. Eligibility levels will be set by the Board of Directors by August 31st of the preceding year for all categories.

It is the responsibility of the owner and/or rider to be aware of the official earnings of the horse and/or rider as recorded by NRHA. When limits of eligibility are surpassed during the show year, the exhibitor can complete the year in that specific class or division. Any rider participating in a class or division in which he/she (or the horse he/she is riding) is not eligible will be fined \$25 for the first offense. After receipt of the notice, any second offense may result in a fine of \$200. When a horse/rider is found to be ineligible, the earnings will be forfeited to the NRHA. Upon receipt of the earnings, NRHA will redirect the forfeited earnings to the show committee to be redistributed. NRHA will make corrections to the class placing and earnings in the database. It is the responsibility of the ineligible exhibitor to return all forfeited earnings to the NRHA and all prizes and awards to the show secretary.

In regards to a member suspended through the protest procedures, who has attained good standing in the association, their eligibility upon return will reflect the levels of eligibility they had when they were suspended.

CATEGORY 1

(NRHA Approved Ancillary classes; World Champion and Top Ten awards to apply. Requires a General, General Non Pro, Youth or Youth Non Pro membership in order to show.)

OPEN Subject to the general conditions, any rider holding a valid NRHA membership card may show any horse in this class.

INTERMEDIATE OPEN Open to any rider holding a valid NRHA membership card and also meets the current policy requirements as set forth by the NRHA Board of Directors. For members giving up Non Pro cards please refer to the Non Pro Conditions.

LIMITED OPEN Open to any rider holding a valid NRHA membership card and also meets the current policy requirements as set forth by the NRHA Board of Directors. For members giving up Non Pro cards please refer to the Non Pro Conditions.

ROOKIE PROFESSIONAL Open to any rider holding a valid NRHA General card, and also meets the current policy requirements as set forth by the NRHA Board of Directors. Those holding a Youth and/or Non Pro card are not eligible for this class. Can run concurrent with any Category 1 Open, Intermediate Open, or Limited Open class.

NON PRO Open to any rider holding a valid NRHA Non Pro card as defined in the Non Pro section of the *NRHA Handbook*.

INTERMEDIATE NON PRO Open to any rider holding a valid

NRHA Non Pro card and also meets the current policy requirements as set forth by the NRHA Board of Directors.

LIMITED NON PRO Open to any rider holding a valid NRHA Non Pro card and also meets the current policy requirements as set forth by the NRHA Board of Directors.

PRIME TIME NON PRO For persons 50 and older as of January 1 of the NRHA year who hold a valid NRHA Non Pro card. This class may run concurrent with the Category 1 Non Pro, Intermediate Non Pro, or Limited Non Pro class.

NOVICE HORSE LEVEL 2 Subject to the general conditions and also meets the current policy requirements as set forth by the NRHA Board of Directors. Also available in the Non Pro division, however, the Non Pro division would be restricted to riders with a valid NRHA Non Pro card and would be restricted to the rules of ownership as stated in the Non Pro Conditions.

NOVICE HORSE LEVEL 1 Subject to the general conditions and also meets the current policy requirements as set forth by the NRHA Board of Directors. Also available in the Non Pro division, however, the Non Pro division would be restricted to riders with a valid NRHA Non Pro card and would be restricted to the rules of ownership as stated in the Non Pro Conditions.

CATEGORY 2

NRHA Approved Aged Shows (Futurity, Derby and other approved Aged Shows; see G. Aged Show Conditions. Requires a General, General Non Pro, Youth or Youth Non Pro membership in order to show.)

LEVEL 4 OPEN Any rider holding a valid NRHA membership card may show in this division.

LEVEL 3 OPEN Open to any rider holding a valid NRHA membership card and also meets the current policy requirements as set forth by the NRHA Board of Directors. For members giving up Non Pro cards please refer to the Non Pro Conditions.

LEVEL 2 OPEN Open to any rider holding a valid NRHA membership card and also meets the current policy requirements as set forth by the NRHA Board of Directors. For members giving up Non Pro cards please refer to the Non Pro Conditions.

LEVEL 1 OPEN Open to any rider holding a valid NRHA membership card and also meets the current policy requirements as set forth by the NRHA Board of Directors. For members giving up Non Pro cards please refer to the Non Pro Conditions.

PRIME TIME OPEN AGED SHOW Open to any rider holding a valid NRHA membership card who is 50 or older as of January 1 of the NRHA year. This class may run concurrent with the Category 2 Level 4, Level 3, Level 2 or Level 1 Open class.

LEVEL 4 NON PRO Open to any rider holding a valid NRHA Non Pro card.

LEVEL 3 NON PRO Open to any rider holding a valid NRHA

Non Pro card and also meets the current policy requirements as set forth by the NRHA Board of Directors.

LEVEL 2 NON PRO Open to any rider holding a valid NRHA Non Pro card and also meets the current policy requirements as set forth by the NRHA Board of Directors.

LEVEL 1 NON PRO Open to any rider holding a valid NRHA Non Pro card and also meets the current policy requirements as set forth by the NRHA Board of Directors.

PRIME TIME NON PRO AGED SHOW Open to any rider holding a valid NRHA Non Pro card who is 50 or older as of January 1 of the NRHA year. This class may run concurrent with the Category 2 Level 4, Level 3, Level 2 or Level 1 Non Pro class.

SNAFFLE BIT or HACKAMORE Subject to the general conditions but limited to 3, 4, and/or 5 year old horses to be shown in a smooth snaffle bit with a broken mouthpiece (conventional O ring, eggbutt or D ring) with ring no larger than 4" (102 mm) and no smaller than 2" (51 mm). One inch (25 mm) in from the cheek the mouthpiece must be a minimum $\frac{5}{16}$ " (8 mm) diameter with a gradual decrease to the center of the snaffle. Optional curb strap is acceptable, however curb chains are not acceptable. A flexible, braided rawhide, leather, or rope bosal, the core of which may be either rawhide or flexible cable, may be used in lieu of a snaffle bit, but can be no larger than $\frac{3}{4}$ " (19 mm) in diameter at the cheek; there must be a minimum of a 2 finger space (approximately $1\frac{1}{2}$ " [38 mm]) between the bosal and the horse's nose. Absolutely no rigid material will be permitted under the jaw or on the noseband in connection with the bosal, regardless of how covered or padded. Horse hair bosals are prohibited. Horses entered in this class may be ridden with one or two hands at any time during the class.

Show committees are allowed to offer the following Snaffle Bit or Hackamore classes or any combination of these classes: 3 year old; 3 and 4 year old; 4 year old and under, 5 and under; 4 and 5 year old. Open and Non Pro divisions may be offered.

7&UP: Open to any rider holding a valid NRHA card and horses that are 7 years of age or older. Refer to the competition license section of the *NRHA Handbook* to determine the age of the horse. Also available in the Non Pro division, however, the Non Pro division would be restricted to riders with a valid NRHA Non Pro card and would be restricted to the rules of ownership as stated in the Non Pro conditions.

CATEGORY 3

(See Youth Show Rules and Regulations. Requires a Youth or Youth Non Pro membership in order to show.)

YOUTH (10 & UNDER SHORT STIRRUP) Open to any Youth rider who is age 10 or under on January 1 of the current NRHA year. This class is to be run with the Short Stirrup pattern

(Pattern 12) only. Riders may use a horse without the restrictions of ownership for Youth classes as defined in the Youth Conditions. This class will not count for Top Ten standings nor toward Youth Rookie (18 & Under) or Rookie eligibility. There will be no penalty for holding the saddle with either hand. The rider may ride with standard reins, or with any type of closed reins and may ride with one or two hands on the reins at any time during the class.

YOUTH (13 & UNDER) Open to any Youth rider who is age 13 or under on January 1 of the current NRHA year. Riders must use horses with ownership as defined in the Youth Show Rules and Regulations.

YOUTH (14–18) Open to any Youth rider who is age 14 to 18 on January 1 of the current NRHA year. Riders must use horses with ownership as defined in the Youth Show Rules and Regulations.

YOUTH ROOKIE (18 & Under) Open to any youth rider and also meets the current policy requirements as set forth by the NRHA Board of Directors. Riders may use a horse without the restrictions of ownership for Youth classes as defined under Youth Conditions. Will not count toward Top Ten Standings. Youth Rookie may be run concurrent only with Youth classes.

UNRESTRICTED YOUTH Open to Youth members 18 & under. Rider may use a horse without the restrictions of ownership as defined under the Youth Conditions. This class will not count for Top Ten standings. It may be run concurrent only with Youth classes.

CATEGORY 4

(NRHA approved Breed Restricted classes (excluding aged shows) restricted by breed. NRHA rules to apply, but not for NRHA World Champion and Top Ten awards. Requires a General, General Non Pro, Youth or Youth Non Pro membership in order to show.)

- Jr. Reining
- Sr. Reining
- All Age Reining
- Amateur Reining
- Youth Reining
- Open Reining
- Non Pro Reining

CATEGORY 5

(NRHA approved Ancillary classes, NRHA rules to apply, but not for World Champion and Top Ten awards. Requires a General, General Non Pro, Youth or Youth Non Pro membership in order to show.)

ANCILLARY GELDING INCENTIVE CLASSES Any ancillary class may offer this division. Entry into this class may be made only after entry into the corresponding class. The added money of the Gelding Incentive class cannot be higher

than the added money of the corresponding class. These classes may be jackpotted or may have added money. There may or may not be a judges fee.

INTERMEDIATE HORSE LEVEL Subject to the general conditions and also meets the current policy requirements as set forth by the NRHA Board of Directors. Also available in the Non Pro division, however, the Non Pro division would be restricted to riders with a valid NRHA Non Pro card and would be restricted to the rules of ownership as stated in the Non Pro Conditions.

ROOKIE LEVEL 2 Open to any rider holding a valid NRHA Non Pro card and also meets the current policy requirements as set forth by the NRHA Board of Directors. Riders may use a horse without the restrictions of ownership for Non Pro classes as defined under Non Pro Conditions. Horses are to be shown one handed. Rookie Level 2 reining can only be run concurrent with Rookie Level 1 or Prime Time Rookie. In order to offer the Rookie Level 2, Rookie Level 1 must also be offered.

ROOKIE LEVEL 1 Open to any rider holding a valid NRHA Non Pro Card and also meets the current policy requirements as set forth by the NRHA Board of Directors. Riders may use a horse without the restrictions of ownership for Non Pro classes as defined under Non Pro Conditions. Horses are to be shown one handed. Rookie Level 1 reining can only be run concurrent with Rookie Level 2 or Prime Time Rookie.

PRIME TIME OPEN DIVISION Open to any rider holding a valid NRHA membership card who is 50 or older as of January 1. This class may run concurrent with the Category 1 Open, Intermediate Open, Limited Open or Rookie Professional class. Money won in Prime Time competition will not count towards World Champion awards and will be used for determining eligibility status for the Rookie class only.

PRIME TIME ROOKIE Open to any rider holding a valid NRHA Non Pro card who is 50 or older as of January 1. Entry in this class may be made only after entering either the Rookie Level 1 or Rookie Level 2 class. This class must run concurrent with a regular Rookie class. Money won in Prime Time Rookie competition will not count toward World Champion Awards and will be used for determining eligibility status for the Rookie class only.

MASTERS NON PRO Open to any rider holding a valid Non Pro card who is 60 or older as of January 1.

SENIOR HORSE Subject to the general conditions but restricted to horses that are 6 years of age or older and class must also be FEI approved. Refer to the competition license section of the *NRHA Handbook* to determine the age of the horse. Also available in the Non Pro division, however, the Non Pro division would be restricted to riders with a valid NRHA Non Pro card and would be restricted to the rules of ownership as stated in the Non Pro Conditions.

CATEGORY 6

(NRHA Approved Closed Aged Shows, NRHA rules to apply, but not for World Champion and Top Ten awards, see G. Aged Show Conditions. Requires a General, General Non Pro, Youth or Youth Non Pro membership in order to show.)

Competition in this category is “closed.” Closed competitions for these purposes are defined as those not open to all participants other than as described and defined in the *NRHA Handbook*. Closed aged shows require entry using specific criteria other than defined in the *NRHA Handbook*, i.e. specific breeders’ futurities and derbies that require stallion subscription, foal nomination, breed or gender restrictions, or other such requirements to enter.

The NRHA Executive Committee will act on shows applying for approval as a “closed” aged show, but not specifically described herein. The NRHA will consider the merit of any show requesting approval as a “closed” competition.

The Category 6 classes are to be patterned after the Category 2 classes.

GELDING INCENTIVE CLASSES Any Category 2 or 6 class may offer a Gelding Incentive class. Entry into this class may be made only after entry into the corresponding class. The added money of the Gelding Incentive class cannot be higher than the added money of the corresponding class. The Gelding Incentive class may be jackpotted or may have added money. There may or may not be a judges fee.

MARE INCENTIVE CLASSES Any Category 2 or 6 class may offer a Mare Incentive class. Entry into this class may be made only after entry into the corresponding class. The added money of the Mare Incentive class cannot be higher than the added money of the corresponding class. The Mare Incentive class may be jackpotted or may have added money. There may or may not be a judges fee.

CATEGORY 7

(NRHA Approved Affiliate Championship classes; requires qualification through the NRHA Affiliate Championship program to enter. Requires a General, General Non Pro, Youth or Youth Non Pro membership in order to show.)

CATEGORY 8

(NGB & FEI COMPETITIONS)

(NGB-National Governing Body, FEI-Federation Equestre Internationale; to include recognized and/or approved events such as World Equestrian Games, Pan Am Games, CRIs-Concours de Reining International, CRIOS-Concours de Reining Internationale Official, etc.)

APPROVED CATEGORY 8 events are those events that are run concurrently with NRHA classes and seek NRHA approval. (example: CRI classes that are run concurrently with NRHA Open)

RECOGNIZED CATEGORY 8 events are those events that are run separately from NRHA classes or events but seek approval from the NRHA. (example: FEI World Equestrian Games)

CATEGORY 9

(Freestyle classes only, NRHA rules to apply, but not for World Champion and Top Ten awards. See Freestyle Reining section of the *NRHA Handbook*. Requires a General, General Non Pro, Youth or Youth Non Pro membership in order to show.)

FREESTYLE OPEN Open to any rider holding a valid NRHA membership card.

FREESTYLE NON PRO Open to any rider holding a valid NRHA Non Pro card.

CATEGORY 10

(Entry level classes only. NRHA rules to apply. See show conditions section of the *Handbook*. Not for World Champion and Top Ten awards. Requires a General, General Non Pro, Youth, Youth Non Pro, Associate, Associate Youth, or Associate Non Pro membership in order to show.)

ENTRY LEVEL RIDE & SLIDE OPEN LEVEL 2 Open to any rider holding a valid NRHA membership card and also meets the current policy requirements as set forth by the NRHA Board of Directors.

ENTRY LEVEL RIDE & SLIDE NON PRO LEVEL 2 Open to any rider holding a valid NRHA membership card and also meets the current policy requirements as set forth by the NRHA Board of Directors. General members must obtain Non Pro status but Associate members do not need to have completed a Non Pro Declaration; however they must be eligible to attain NRHA Non Pro status in order to show in these classes. Rider may use a horse without the restrictions of ownership as defined under the Non Pro Conditions.

ENTRY LEVEL RIDE & SLIDE YOUTH LEVEL 2 Open to any rider who is age 18 or under on January 1 and holding a valid NRHA Youth membership card and also meets the current policy requirements as set forth by the NRHA Board of Directors. Rider may use a horse without the restrictions of ownership as defined under the Youth Conditions.

ENTRY LEVEL RIDE & SLIDE OPEN LEVEL 1 Open to any rider holding a valid NRHA membership card and also meets the current policy requirements as set forth by the NRHA Board of Directors.

ENTRY LEVEL RIDE & SLIDE NON PRO LEVEL 1 Open to any rider holding a valid NRHA membership card and also meets the current policy requirements as set forth by the NRHA Board of Directors. General members must obtain Non Pro status but Associate members do not need to have completed a Non Pro Declaration; however they must be eligible to attain NRHA Non Pro status in order to show in these classes. Rider may use a

horse without the restrictions of ownership as defined under the Non Pro Conditions.

ENTRY LEVEL RIDE & SLIDE YOUTH LEVEL 1 Open to any rider of who is age 18 or under on January 1 holding a valid NRHA Youth membership card and also meets the current policy requirements as set forth by the NRHA Board of Directors. Rider may use a horse without the restrictions of ownership as defined under the Youth Conditions.

GREEN REINER LEVEL 1 Open to any rider holding a valid NRHA membership card and also meets the current policy requirements as set forth by the NRHA Board of Directors. General members must obtain Non Pro status but Associate members do not need to have completed a Non Pro Declaration; however they must be eligible to attain NRHA Non Pro status in order to show in these classes.

GREEN REINER LEVEL 2 Open to any rider holding a valid NRHA membership card and also meets the current policy requirements as set forth by the NRHA Board of Directors. General members must obtain Non Pro status but Associate members do not need to have completed a Non Pro Declaration; however they must be eligible to attain NRHA Non Pro status in order to show in these classes.

Category 11

NRHA approved classes not corresponding to other NRHA Categories, NRHA rules to apply, but not for rider/horse eligibility, Top 20 Program or World Champion and Top Ten awards. Requires NRHA General, General Non Pro, Youth or Youth Non Pro Membership in order to show.

Category 12

NRHA Nominator Incentive earnings, not for rider/horse eligibility, Top 20 Program or World Champion and Top Ten awards.

E. UNAPPROVED CLASSES

AFFILIATE LEVEL CLASSES The NRHA recognizes the need for diversity in classes held at different levels of competition and in different geographical areas, as well as to generate promotional activity for affiliate groups. This diversity allows for growth and development of affiliate and uniqueness in show management.

Among these types of classes are: Ladies, Men's, Leadline and many additional classes with a variety of individual conditions written by the affiliate or show management. These classes often use NRHA rules with a noted variation in show conditions to accommodate the specific class.

NRHA does not sanction these classes for national competition, but does recognize and encourage their use for the growth and development of the affiliates, the interest of the exhibitors, and the overall management of the reining show.

Official NRHA trophies and plaques will not be awarded in Affiliate Level classes.

F. EVENT APPROVAL

(1) An NRHA event may contain one or multiple shows, and is defined as the entire duration of the Reining from start to finish.

(2) An NRHA show is a grouping of classes which may also be referred to as a slate of classes.

(3) Official NRHA event approval forms must be submitted to the NRHA office by the deadline as follows:

AA Level Events—not less than 180 days prior to the entry closing date of the event.

A Level Events—not less than 120 days prior to the entry closing date of the event.

BB Level Events—not less than ninety (90) days prior to the entry closing date of the event.

B Level Events—not less than sixty (60) days prior to the entry closing date of the event.

C Level Events—not less than thirty (30) days prior to the first day of the event.

D Level Events—not less than thirty (30) days prior to the first day of the event.

Any changes made to information on a submitted event approval must be done in a timely manner and is at the discretion of the NRHA as to whether or not the change can be accepted. Any event submitted for NRHA approval that is received by post, fax, or email in the NRHA office after the appropriate deadline or an approval form that is not completed in full may be subject to a \$100 late fee.

(4) Approvals are awarded on a first come basis except in the case of an established event. To preserve a preferential show date, an established event must contact the NRHA office in writing, not less than six (6) months in advance of the anticipated event date.

(5) The NRHA Executive Committee may deny approval of events scheduled during the same show week (defined Monday–Sunday) as an NRHA-owned event. NRHA Executive Committee approval will be required for any NRHA sanctioned events to be held in the same geographic region or within 500 miles of an Affiliate or Continental Finals.

(6) NRHA may approve events meeting approval criteria outlined in the *NRHA Handbook*. Any event that appears not to be in the best interest of the sport of Reining or the National Reining Horse Association may be denied approval by the NRHA Executive Committee.

(7) **Event Classifications:**

(a) **D Events:**

(A) Ride & Slide Event.

(B) Follow all NRHA guidelines as set forth in the *NRHA Handbook*.

(C) Show Secretary must be NRHA certified or pre-approved by the NRHA office and must have a current NRHA General membership.

(b) C Events:

(A) \$0–\$999 added money to the entire event.

(B) Follow all NRHA guidelines as set forth in the *NRHA Handbook*.

(C) Show secretary must be NRHA certified by the NRHA office and must have a current NRHA General membership.

(D) Must have show representative who is a current NRHA General member.

(c) B Events:

(A) \$1,000–\$14,999 added money to entire event.

(B) Follow all NRHA guidelines as set forth in the *NRHA Handbook*.

(C) Must have a show secretary, show manager and show representative/steward. All three must have current NRHA General memberships at the time the show approvals are submitted to the NRHA Office.

(D) Show Secretary or show manager must be certified by the NRHA.

(E) Show Representative/Steward, Show Secretary, and Show Manager must be three separate individuals and the Show Representative/Steward cannot be an immediate family member (as defined in the Non Pro conditions) of the Show Secretary and/or the Show Manager.

(d) BB Events:

(A) \$15,000–\$49,999 added money to the entire event.

(B) Follow all NRHA guidelines as set forth in the *NRHA Handbook*.

(C) Must have a show secretary, show manager and show representative /steward. All three must have current NRHA General memberships at the time the show approvals are submitted to the NRHA Office.

(D) Show Secretary or show manager must be certified by the NRHA.

(E) Show Representative/Steward, Show Secretary, and Show Manager must be three separate individuals and the Show Representative/Steward cannot be an immediate family member (as defined in the Non Pro conditions) of the Show Secretary and/or the Show Manager.

(F) Videographer for all classes is strongly recommended.

(e) A Events:

(A) \$50,000–\$99,999 added money to entire event.

(B) Follow all NRHA guidelines as set forth in the *NRHA Handbook*.

(C) Must have a show secretary, show manager and show representative/steward. All three must have current NRHA General memberships at the time the show approvals are submitted to the NRHA Office.

(D) Show Secretary or show manager must be certified by the NRHA.

(E) Show Representative/Steward, Show Secretary, and Show Manager must be three separate individuals and Show Representative/Steward cannot be an immediate family member (as defined in the Non Pro conditions) of the Show Secretary and/or the Show Manager.

(F) Judges not to judge over 12 hours per day, actual judging, not including breaks. If a judge judges over the 12 hour limit, the event may be fined \$500 for the first hour and \$100 for each additional hour over. The Show Representative/Steward (s) will be required to report this to NRHA. Fines that are incurred due to conditions that are unforeseen may be waived following an appeal to the Executive Committee.

(G) Videographer for all classes.

(f) AA Events:

(A) \$100,000 or more added money to entire event.

(B) Follow all NRHA guidelines as set forth in the *NRHA Handbook*.

(C) Must have a Show Secretary, Show Manager and Show Steward. All three must have current NRHA General memberships at the time the show approvals are submitted to the NRHA Office.

(D) Show Secretary or Show Manager must be certified by the NRHA.

(E) Show Steward, Show Secretary and Show Manager must be three separate individuals and cannot be immediate family members (as defined in the Non Pro Conditions).

(F) Judges not to judge over twelve (12) hours per day, actual judging, not including breaks. If a judge judges over the twelve (12) hour limit, the event may be fined \$500 for the first hour and \$100 for each additional hour over. The Show Steward(s) will be required to report this to NRHA. Fines that are incurred due to conditions that are unforeseen may be waived following an appeal to the Executive Committee.

(G) An NRHA Show Steward must officiate for the entire duration of the show.

(H) Professional videographer for all classes. At all shows where there is an official videographer, exhibitors by entering are giving permission to NRHA to use any and all video for educational purposes. Permission must also be obtained from the show's management.

(8) All trophy and/or plaque payments must be submitted with the approval form if NRHA official trophies are ordered.

(9) Any authorized board, club or show committee member who is not showing at said show can contract the services of NRHA approved judge(s). The person(s) hiring the judge(s)

will not hire a member of their immediate family (immediate family as defined per the *NRHA Handbook*) to be the (or one of the) official judge(s) of an NRHA approved show. (Except for Category 10 classes.)

(10) Show Manager

(a) Any reputable person may act in the capacity of show manager who can furnish proof that he/she is capable through ability or experience. A show manager must have a current year general NRHA membership recorded solely in their name.

(b) One of the individuals designated on the show approval application as show manager or show secretary must have attended an NRHA Show Secretary Seminar and become certified within five (5) years preceding the date of the scheduled show.

(c) The show manager shall:

(i) be the person in charge of the National Reining Horse Association division of the show, but may not serve as show secretary or rep/steward at a show for which they are manager.

(ii) have authority to enforce all rules referring to the show and he/she may excuse any horse or exhibitor from the show prior to, during or after the judging.

(iii) have jurisdiction over preparing and mailing all entry blanks, premium lists, catalogs, etc.

(iv) be present on the show grounds for the duration of the show. In the event an emergency arises and the show manager is unable to fulfill his/her duties, an acting manager should be appointed. The show manager must submit a written explanation to NRHA for his/her absence. The acting show manager must then remain at the show grounds for the duration of the show and must meet the requirements as set forth in the *NRHA Handbook*

(v) at all times extend every effort to satisfy the comfort of the horses, exhibitors, spectators and officials and will be held responsible for maintaining clean and orderly conditions throughout the show. The show manager, along with the show rep/steward, shall also be responsible for ensuring humane treatment of horses is adhered to on show grounds through policing of stalling areas and practice pens at various times throughout the show.

(vi) receive written or verbal complaints from exhibitors trainers, owners, show participants and other NRHA members of incidents of cruel, abusive or inhumane treatment of horses on show grounds or any other complaints or incidents of rule violations and shall forward such to NRHA.

(vii) upon a report or discovery of inhumane treatment

immediately investigate the incident and report it to NRHA. Show Management shall make every effort to obtain the concurrence of any NRHA-approved judge/steward or NRHA Professional on the grounds if available. Any verbal or written warning performed by the show manager at a show for inhumane treatment is to be reported in writing to NRHA. If an incident is later reported to NRHA and knowledge is gained that the show manager was present but did not report the incident, this could jeopardize their ability to manager an NRHA-approved show in the future.

(viii) Shows should not run more than 12 consecutive hours from the scheduled starting time to the conclusion of the show, excluding all breaks. Show management could be subject to a review and a possible fine for every hour or portion thereof past the 12-hour limit. Fines that are incurred due to conditions that are unforeseen may be waived following an appeal to the Executive Committee.

(ix) be responsible for upholding all NRHA rules and regulations as set forth in the NRHA Handbook.

(x) It is show management's responsibility to ensure that the show classification requirements are met for their event and that proper documentation is kept in the event of a protest. Failure to do so may result in a review and possible disciplinary action.

(11) Show Secretary

(a) Any reputable person may act in the capacity of show secretary who can furnish proof that he/she is capable through ability or experience. A show secretary must have a current year general NRHA membership recorded solely in their name.

(b) One of the individuals designated on the show approval application as show manager or show secretary must have attended an NRHA Show Secretary Seminar and become certified within five (5) years preceding the date of the scheduled show.

(c) The show secretary shall:

(i) accurately maintain and record both entries and show results, including aiding exhibitors in determining their eligibility.

(ii) keep a complete set of results and copies of judges' score sheets on file for at least one year from the date of the show

(iii) be responsible to oversee any and all show related fees (e.g. entry fees, judges fees, stall fee, etc), NRHA 5% payment, trophy/plaque fees, office charges, etc. (when applicable) and for any fees collected for membership on behalf of NRHA and NRHyA.

(iv) be responsible for checking entries to ensure the exhibitor and owner/co-owner are current members of the NRHA. The secretary is also responsible for checking entries

to ensure the horse has a competition license reflecting the current ownership.

(v) be present on the show grounds for the duration of the show. In the event an emergency arises and the show secretary is unable to fulfill his/her duties, an acting secretary should be appointed. The show secretary must submit a written explanation to NRHA for his/her absence. The acting show secretary must then remain at the show grounds for the duration of the show and must meet the requirements as set forth in the *NRHA Handbook*.

(vi) be responsible for upholding all NRHA rules and regulations as set forth in the *NRHA Handbook*.

(vii) It is show management's responsibility to ensure that the show classification requirements are met for their event and that proper documentation is kept in the event of a protest. Failure to do so may result in a review and possible disciplinary action.

(12) It is mandatory that all approved shows utilize judges from the NRHA Judges List.

(13) The Show Representative must have been an NRHA General member in good standing for at least one full calendar year. It is recommended by the Board of Directors that the representative be a current NRHA Judge or NRHA Steward. The representative will be responsible for representing the interests of the contestants to the judge(s) and show management, and will be required to submit to NRHA a representative report not more than fifteen (15) days after the show. Should the representative leave the show grounds for any reason, he/she will be responsible to appoint an alternate representative. The representative must represent all contestants with the show management and judge/judges and will be the sole liaison with said management or judge/judges. Contestants and owners should direct any and all concerns with respect to judging to the appointed Show Representative and limit interactions with Judges to the polite exchange of pleasantries until the conclusion of the event. The representative must report if he observes any horse being abused or if there are actions by any contestant detrimental to the best interest of the Association such as: loud and profane language, drunkenness or being under the influence of intoxicants; use of devices not permitted by NRHA rules; any unsportsmanlike conduct toward judges, show management, or other exhibitors; or any other infraction of NRHA rules.

(14) An NRHA show steward who is a current NRHA General member must serve as an Official at AA events. They are to be employed by the show management and the Steward's name is to be listed on the show approval application. The Steward will be responsible to carry out all current stated responsibilities of an NRHA Show Representative/Steward, including represent

the interests of the contestants to the judge(s) and show management; as well as being available to aid judges and show management with Association rules and will investigate any situation where NRHA rules as listed in this *NRHA Handbook* are not upheld.

(15) An NRHA approved event that intends to cancel must have approval from the Executive Committee prior to cancellation. Special consideration will be given in the event of emergency cancellations due to circumstances that would jeopardize the safety of participants. The show management must notify the NRHA office by fax, phone, or email. The request will be submitted to the NRHA Executive Committee for review and approval to cancel. The NRHA will determine if materials, including trophies and/or plaques are to be returned to the NRHA office at the show's expense. Failure to follow procedures may result in a \$250 fine and may jeopardize future show approvals.

G. ANCILLARY SHOW CONDITIONS

A full slate of ancillary classes is defined as those offering the following classes: Open, Limited Open, Non Pro, Limited Non Pro, Youth 13 & Under, Youth 14–18 and Rookie Level 2.

(1) Ancillary events cannot be restricted by any means other than the requirements set forth.

(2) Ancillary events must have a minimum of one (1) open class, one (1) Youth 13 & Under class and one (1) Youth 14–18 class. Any other classes from Category 1, 3, 5 and 9 can be held in an ancillary show.

(3) In NRHA approved ancillary events, a minimum of one (1) Open reining must be offered. However, events with multiple ancillary shows, multiple show applications, a minimum of one (1) Open class must be offered. Example: a three day reining with two slates of classes would be required to hold only one Open class to meet approval provided other criteria are met.

(4) All riders, owners and co-owners must be NRHA General members prior to showing in an Ancillary show. If the rider wishes to show in any Non Pro classes, they must apply for Non Pro status prior to showing.

(5) All horses must have an NRHA Competition License prior to showing in an Ancillary show.

(6) **Added Money:** Ancillary shows must have a minimum of \$500 Added Money.

(a) The following Category 1 classes may not be jackpotted: Open, Intermediate Open, Limited Open, and Non Pro; other classes may be approved as a jackpot.

(b) Open added money must be equal to or greater than the added money in any other Category 1 class when the added money in any other Category 1 class equals or exceeds \$500.

(c) Limited Open added money may not exceed \$500 and

cannot exceed the added money in the Open or Intermediate Open class at a specific show.

(d) Intermediate Non Pro added money may not exceed the added money in the Non Pro.

(e) Limited Non Pro added money may not exceed \$500.

(f) Novice Horse Level 1 may not exceed \$1,000 in added money. Novice Horse Level 2 may not exceed \$2,500 in added money. The added money of Novice Horse Level 1 cannot exceed that of Level 2.

(g) The added money of Novice Horse Level 2 cannot exceed that of Intermediate Horse.

(h) Rookie Level 1 class must be a jackpot.

(i) Rookie Level 2 class added money may not exceed \$100.

(j) Youth class added money may not exceed \$100.

(7) Entry Fees: Entry fees can be no more than ten percent (10%) of the added money for the respective division. For jackpot classes, entry fees can be no more than \$50. (Exception: Rookie Level 2)

(a) Rookie Level 1 and Level 2 entry fees may not exceed that of the Limited Non Pro.

(b) Rookie Level 1 entry fees may not exceed that of the Rookie Level 2.

(c) Rookie Level 2 class entry fee may be no more than \$20.

(d) Gelding and Mare Incentive classes entry fees may not exceed fifty percent (50%) of the fees in the classes that they complement.

(e) In regular NRHA youth reinings, the entry fee may not exceed \$10. For added money youth reinings, the entry fee may not exceed ten percent (10%) of the added money.

(8) Judges fees may not exceed the entry fee.

(a) Rookie judge's fee may not exceed that of the Limited Non Pro.

(b) A judge's fee may not be charged in youth classes.

(9) Show management retains and remits to the NRHA the standard five percent (5%) show fee.

(10) Show management must retain between thirty (30%) and fifty percent (50%) of the entry fees after deducting the NRHA trophy fee (if an official NRHA trophy is ordered) and the NRHA show fee of five percent (5%). All classes within the show must have the same retainage.

(11) To qualify for an NRHA Lawson Trophy, a class must offer \$2,000 or more added.

(12) Only one (1) Ancillary event with a Lawson Trophy reining may be held within 350 miles or 550 Kilometers driving distance (one way) on the same day.

(13) A single judge may be used for NRHA approved classes not qualifying for a Lawson Trophy. At least two (2) chair judges must be used in all NRHA approved classes with added money of \$2,000 up to \$9,999. At least three (3) chair judges are recom-

mended, but a minimum of two (2) chair judges are required for all NRHA approved classes with added money of \$10,000 up to \$49,999. Five (5) chair judges are recommended, but a minimum of three (3) chair judges are required for all NRHA approved classes with added money of \$50,000 or more.

(14) Category 1 classes will be limited to one run and entries cannot be restricted by number.

(15) Any event wishing to hold an elimination run prior to a finals for a Category 1 class, must request such in writing through the NRHA office. Eliminations will be allowed if meeting the following criteria:

(a) The show has a large spectator audience and needs to hold a class with a controlled number of entries for a special evening or afternoon performance.

(b) The show has a large number of entries, history of large numbers of entries, or can offer proof that the show expects a large number of entries.

(c) The show management has a history of responsible reporting of monies earned and proper paybacks to the NRHA office.

(d) An elimination round will be used to determine a set number of finalists only—with no payback figured for this round. The number of finalists to be determined by the total number of horses entered in the class with a minimum of two (2) more than percentages require in the appropriate NRHA payback schedule, with the maximum to be determined by show management. Judge's score card for the elimination round and finals will accompany the results.

(16) In order to place in a Lawson Trophy Reining, a horse must be shown in the final round of that class.

(17) All standards of Judging will apply. (See Rules for Judging)

(18) Must use NRHA patterns 1–12. Pattern 12 is to only be used for the Youth 10 & Under Short Stirrup class.

H. AGED SHOW AND CLOSED AGED SHOW CONDITIONS

(1) Aged shows are restricted by the horse's age only. Closed Aged shows are restricted by the horse's age and some other provision (ie. Foal enrollment program, breeders incentive, etc).

(2) NRHA Aged Shows must offer a minimum of one (1) Level 4 Open and one (1) Level 4 Non Pro class. Any other class in Categories 2 and 6 can be held in an aged show.

(3) Added Money:

(a) An Aged Show must have a minimum of \$2000 added money.

(b) Level 2 Non Pro may not exceed the added money in the Level 4 Non Pro or Level 3 Non Pro in Category 2 or Category 6 classes.

(4) All riders, owners and co owners must be NRHA General Members prior to showing in an Aged Show. If the rider wishes to show in any Non Pro classes, they must apply for Non Pro status prior to showing.

- (5) All horses must have an NRHA Competition License prior to showing in an Aged or Closed Aged show.
- (6) Show management retains and remits to the NRHA the standard five percent (5%) show fee.
- (7) Show management retains no more than fifty percent (50%) of the entry fees after deducting the NRHA trophy fee (if an official NRHA trophy is ordered) and the NRHA show fee of five percent (5%).
- (8) In order to place in a class, a horse must be shown in the final round of that class.
- (9) It is recommended that show management submit complete Terms & Conditions of the show with the approval.
- (10) A single chair judge may be used for NRHA approved classes not qualifying for a Lawson Trophy. At least two (2) chair judges must be used in all NRHA approved classes with added money of \$2,000 up to \$9,999. At least three (3) chair judges are recommended, but a minimum of two (2) chair judges are required for all NRHA approved classes with added money of \$10,000 up to \$49,999. Five (5) chair judges are recommended, but a minimum of three (3) chair judges are required for all NRHA approved classes with added money of \$50,000 or more.
- (11) The NRHA Board of Directors determines, after notice to and consideration of the concerns of other NRHA sponsored or sanctioned aged shows, that the show requesting sanction will not adversely impact the other sponsored or sanctioned aged shows.
- (12) The show requesting sanction is deemed to have show management, facilities, and scheduling that will bring credit to the NRHA.
- (13) *NRHA Handbook* rules must be followed unless specifically altered by the NRHA Board of Directors.
- (14) NRHA will make the appropriate official trophy available to these approved aged shows for the posted costs. Trophies will be consistent with added money levels in Ancillary shows (see H. Trophies) with the exception that Lawson Trophy are available to all Category 2 divisions with \$2,000 or more in added money.
- (15) All standards of Judging will apply. (See Rules for Judging)
- (16) Must use NRHA patterns 1–11.

I. BREED RESTRICTED SHOW CONDITIONS

- (1) Breed Restricted shows are restricted by the breed of the horse.
- (2) Breed Restricted Shows can offer any class in Category 4.
- (3) There is no minimum requirement for added money.
- (4) All riders, owners and co-owners must be NRHA General Members prior to showing in a Breed Restricted Show. If the rider wishes to show in any Non Pro classes, they must apply for Non Pro status prior to showing.

- (5) All horses must have an NRHA Competition License prior to showing in a Breed Restricted show.
- (6) Show management retains and remits to the NRHA the standard five percent (5%) show fee.
- (7) Show management retains no more than fifty percent (50%) of the entry fees after deducting the NRHA trophy fee (if an official NRHA trophy is ordered) and the NRHA show fee of five percent (5%).
- (8) In order to place in a class, a horse must be shown in the final round of that class.
- (9) Show management must submit a complete Terms & Conditions of the event with the approval.
- (10) A single chair judge may be used for NRHA approved classes not qualifying for a Lawson Trophy. At least two (2) chair judges must be used in all NRHA approved classes with added money of \$2,000 up to \$9,999. At least three (3) chair judges are recommended, but a minimum of two (2) chair judges are required for all NRHA approved classes with added money of \$10,000 up to \$49,999. Five (5) chair judges are recommended, but a minimum of three (3) chair judges are required for all NRHA approved classes with added money of \$50,000 or more.
- (11) NRHA will make the appropriate official trophy available to these approved Breed Restricted Shows for the posted costs. Trophies will be consistent with added money levels in Ancillary shows. (see H. Trophies).
- (12) All standards of Judging will apply. (See Rules for Judging)
- (13) Must use NRHA patterns 1–11.

J. JACKPOT AFFILIATE SHOW CONDITIONS

- (1) Jackpot Affiliate shows must be held by an established NRHA Affiliate and cannot be restricted by any means other than the requirements set forth.
- (2) A \$50 show application fee must be submitted with the show approvals for all affiliate shows.
- (3) Any class from Category 1, 3, 5 and 9 can be held in a Jackpot Affiliate show.
- (4) Jackpot Affiliate Shows can be jackpot only or may have less than \$500 added money to their entire show.
- (5) All riders, owners and co-owners must be an NRHA General member prior to showing in an Jackpot Affiliate show. If the rider wishes to show in any Non Pro classes, they must apply for Non Pro status prior to showing.
- (6) All horses must have an NRHA Competition License prior to showing in an Jackpot Affiliate show.
- (7) Entry fees can be no more than 10% of the added money in the class. For jackpot classes entry fees can be no more than \$50.
- (8) Judges fees cannot exceed the entry fee.
- (9) Show management does not remit the NRHA five percent (5%) retainage fee.
- (10) Show management can retain any percentage of the entry fees.

(11) Category 1 classes will be limited to one run and entries cannot be restricted by number.

(12) All standards of Judging will apply. (See Rules for Judging)

(13) Must use NRHA patterns 1–12. Pattern 12 is to only be used for the Youth 10 & Under Short Stirrup class.

K. ENTRY LEVEL RIDE & SLIDE LEVEL 2 SHOW CONDITIONS

(1) Entry Level Ride & Slide Level 2 shows cannot be restricted by any means other than the requirements set forth.

(2) A \$50 show application fee must be submitted with the show approvals for all Entry Level Ride & Slide Level 2 shows

(3) Any Entry Level Ride & Slide Level 2 class from Category 10 can be held in an Entry Level Ride & Slide Level 2 show.

(4) Entry Level Ride & Slide Level 2 shows can be jackpot only or may have up to \$500 added money in the entire show.

(5) All riders must be an NRHA member prior to showing in an Entry Level Ride & Slide Level 2 show. Non Pro status is not required to show in the Non Pro class.

(6) Horses do not have to have an NRHA Competition License prior to showing in an Entry Level Ride & Slide Level 2 show.

(7) Entry fees are to be determined by show management.

(8) Judges fees cannot exceed the entry fee.

(9) Show management does not remit the NRHA five percent (5%) retainage fee.

(10) Show management can retain any percentage of the entry fees.

(11) All standards of Judging will apply. (See Rules for Judging)

(12) Must use NRHA patterns 1–11.

L. ENTRY LEVEL RIDE & SLIDE LEVEL 1 SHOW CONDITIONS

(1) Entry Level Ride & Slide Level 1 shows cannot be restricted by any means other than the requirements set forth.

(2) A \$30 show application fee must be submitted with the show approvals for all Entry Level Ride & Slide Level 1 shows

(3) Any Entry Level Ride & Slide Level 1 class from Category 10 can be held in an Entry Level Ride & Slide Level 1 show.

(4) Entry Level Ride & Slide Level 1 shows must be jackpot.

(5) All riders must be an NRHA member prior to showing in an Entry Level Ride & Slide Level 1 show. Non Pro status is not required to show in the Non Pro class.

(6) Horses do not have to have an NRHA Competition License prior to showing in an Entry Level Ride & Slide Level 1 show.

(7) Entry fees are to be determined by show management.

(8) Judges fees cannot exceed the entry fee.

(9) Show management does not remit the NRHA five percent (5%) retainage fee.

(10) Show management can retain any percentage of the entry fees.

(11) See NRHA Rules for Judging for allowable usage of two hands and simple lead changes.

(12) May use relaxed patterns. Must submit a pattern diagram with show approval forms. It is the responsibility of the show management to inform the judge of the relaxed pattern prior to horses being shown. The required maneuvers are at least two (2) sliding stops, two (2) circles in each direction, four (4) spins to the left and four (4) spins to the right.

M. GREEN LEVEL SHOW CONDITIONS

(1) Green Level shows cannot be restricted by any means other than the requirements set forth.

(2) A Green Level show must be held in conjunction with an NRHA Ancillary show.

(3) Any green class from Category 10 can be held in a green show.

(4) Green Level shows can be jackpot only and will award Green points.

(5) When exhibitors reach the point levels to earn out of the class they will receive an award.

(6) All riders must be an NRHA member prior to showing in a Green Level show.

(7) Entry fees are to be determined by show management.

(8) Show management cannot charge exhibitors a judge's fee.

(9) Show management does not remit the NRHA five percent (5%) retainage fee.

(10) Show management can retain any percentage of the entry fees.

(11) See NRHA Rules for Judging for allowable usage of two hands and simple lead changes.

(12) Must use NRHA patterns 1–11. However, simple lead changes are allowed.

(13) Green Reiner points will be awarded according to the NRHA Youth Point Scale (See Youth Rules and Regulations).

N. Adaptive Reining Show Conditions

Open to riders with physical or mental disabilities to provide the opportunity to safely and effectively show a reining horse. Not for World Champion and Top Ten Awards. Will not count toward NRHA eligibility.

(1) Adaptive Reining shows cannot be restricted by any means other than the requirements set forth.

(2) Any Adaptive Reining class can be held in an Adaptive Reining Show.

(3) Adaptive Reining classes may not have added money.

(4) All riders must be an NRHA member and must submit NRHA Adaptive Reining Physician Statement to show secretary prior to showing in an Adaptive Reining show.

(5) Horses do not have to have an NRHA Competition License prior to showing in an Adaptive Reining show.

- (6) Entry fees are to be determined by the show management.
- (7) Judges fees cannot exceed the entry fee.
- (8) Show management does not remit the NRHA five percent (5%) retainage fee.
- (9) Show management can retain any percentage of the entry fees.
- (10) See NRHA Rules for Judging for allowable use of two hands and simple lead changes
- (11) May use NRHA Pattern 12 or other relaxed pattern meeting the following guidelines. The required maneuvers are at least one (1) sliding stop, one (1) circle in each direction, a minimum of two (2) spins to the left and a minimum of two (2) spins to the right. Gaits may include a walk, trot and/or lope. It is the responsibility of the show management to inform the judge of the relaxed pattern prior to horses being shown.

O. TROPHIES

- (1) NRHA approved ancillary classes may provide the official trophy or award designated for the class or division. The awards may be purchased from NRHA at the published trophy price plus applicable shipping, taxes, etc. If a show does not offer NRHA trophies, the class winners may elect to purchase the trophy by paying the appropriate trophy fee plus applicable shipping, taxes, etc. Only official NRHA trophies can be deducted from payouts.
- (2) Classes or divisions may present one trophy at the highest qualifying level.
- (3) If ordered, the Lawson Trophy must be presented to the Open and Non Pro class when \$2,000 or more in added money is offered and other special Lawson Trophy qualifications are met. Open and Non Pro are the only classes in Ancillary shows that are allowed presentation of the Lawson Trophy.
- (4) If ordered, the Morrison Trophy is mandatory for classes with \$1,000 added or more, but not qualifying for the Lawson Trophy.
- (5) If ordered, the Pewter Trophy is mandatory for classes with \$500 added or more, but not qualifying for the Lawson Trophy or Morrison Trophy.
- (6) If ordered, the Pewter Trophy is mandatory for the \$200-\$500 added Limited Non Pro class.
- (7) If ordered, the Morrison Freestyle Trophy must be and can only be presented for a \$1,000 or more added Freestyle class.
- (8) First through tenth place awards are mandatory for Youth classes except for Category 10 shows.
- (9) If ordered, plaques are mandatory for Rookie and other approved classes not meeting the added money levels outlined in this section.
- (10) For Category 2 Aged Show awards, refer to G. Aged Show Conditions.

(11) If ordered, the plaque or Pewter Trophy may be used for the Adaptive Reining class.

P. GENERAL SHOW CONDITIONS

(1) All entry forms must accurately and truthfully identify horses, owner (based on records in NRHA database) and rider when the information is asked for from the exhibitor. Any misrepresentation or false statement on the entry form shall constitute unsportsmanlike conduct and will subject owner and/or exhibitor to disciplinary action as set forth in the *NRHA Handbook*, as well as affect the counting of earnings for Top Ten purposes.

(2) All exhibitors and owners/co-owners must be current members of NRHA. All NRHA members may renew or purchase their memberships at the show. Non Pro members may renew at a show if they present their previous year's non pro card to the show secretary. New Non Pro applicants must complete a Non Pro declaration and submit it with the Non Pro fee, a completed membership application and membership dues. If a horse is shown without current NRHA membership for the owner/co-owner and/or rider and it is required, the show will be fined \$10 per offense. The non-current member will be fined \$25 in addition to the cost of his/her membership. Failure to pay could result in suspension and all privileges of membership could be denied. Refer to *NRHA Handbook*, GENERAL RULES AND REGULATIONS, H. FAILURE TO PAY.

(3) All horses in a class must be drawn for position and must run as drawn, except in the case of an event that is running multiple arenas simultaneously. In this case priority is given to one arena and that arena will maintain the draw, while the other arena will allow for flexibility in the draw to assist riders with conflicts between arenas. All horses must have a correct exhibitor number displayed.

(4) The draw must be available to exhibitors at least one hour prior to the first horse entering the arena. In a case where the entries of a class close the night before a class is to be held the draw must be posted by 10:00 p.m. the day the class entries close.

(5) If an entry is made after the draw is posted, it is the decision of the show management as to whether that entry runs first or last. It must be consistent for all entries in that class (except in the case of an exhibitor with multiple horses).

(6) Exhibitors that enter and scratch a class for any reason after the draw has been posted will be liable for any and all fees incurred in connection to entering that class.

(7) Failure to display exhibitor number or displaying incorrect exhibitor number will result in the rider receiving a \$25 fine per offense.

(8) If an entrant misses his/her turn as determined by the draw, he/she will be disqualified from that go round (except for cases where unusual and truly unavoidable circumstances

exist). Each case will be judged on its own merit by the judge(s).

(9) Substitution of riders will not be permitted except by agreement of the show management and NRHA Representative/Steward in case of injury or other extenuating circumstances.

(10) A rider may not show more than three (3) horses in an NRHA class. If a rider rides more than one horse, there should be a spread of at least eight (8) horses between his/her runs. In cases where this minimum spread is not possible due to the number of entries, the spread should be the maximum possible. A horse may be entered only once per class. In the instance where classes are run concurrent, a rider may show three horses per class and a horse may only be shown once. In Adaptive Reining classes a rider cannot show more than one horse in the same class and a horse may be shown a maximum of two (2) times in the same class.

(11) No event may run two separate shows of the same class concurrently as a double judged event.

(12) If a horse is shown without correct ownership on the competition license, when ownership records are required, the rider will each be fined \$25. If a show secretary reports an incorrect owner on show results they will be fined \$10. A second offense may result in the rider being disqualified and forfeited from the class and a \$200 fine.

(13) All horses must be ridden astride.

(14) It is mandatory for all riders to use appropriate western tack and western attire while showing; this would include a long sleeve shirt, western hat or safety helmet, boots, western saddle, and western bridle. (Freestyle reining being exempt based on conditions.) Failure to use appropriate attire will result in a score of 0. The use of a helmet is mandatory in all Adaptive Reining classes.

(15) The Affiliate, Show Committee and all participants, spectators and others, acknowledge that because these rules have been established on the basis of experience and fairness to all who are interested in the betterment of reining horse competition, the NRHA assumes no liability for any injuries, damages or claims of whatever nature from any Affiliate, Show Committee, participant or spectator arising out of performance conducted under the NRHA General Rules and Requirements.

(16) Any person or entity in violation of NRHA rules may be subject to, but not limited to, fines, forfeitures, exclusion from Top Ten standings, probation, and/or disciplinary procedures.

(17) At all shows where there is an official videographer, exhibitors by entering are giving permission to NRHA to use any and all video for educational purposes. Permission must also be obtained from the show's management.

(18) No horse may be shown before its 3-year-old year in NRHA events.

Q. TIES

(1) All ties for 1st place will be worked off if the tied exhibitors agree to participate in a run-off. Tied exhibitors have the alternate option of agreeing not to run-off and to be named co-champions but must determine the winner of the awards by a flip of a coin. If they do not agree, the exhibitor(s) who does not want to run-off will forfeit first place to the other(s). (Exceptions: Freestyle reining—see Freestyle Reining conditions to determine winner or co-champions.)

(2) Ties that are worked off will use the same pattern and order of go as was used during the event; however, there will not be more than one run-off.

(3) If a tie occurs after the run-off, the entrants will be named co-champions; will evenly split 1st and 2nd prize money, but must determine the winner of the awards by a flip of a coin.

(4) In the event of a co-championship, the participant that loses the coin toss does have the option of purchasing a second trophy.

(5) A horse not returning for a run-off without such an agreement will forfeit 1st place prize money regardless of the added money. (If three or more exhibitors have tied for 1st place, the exhibitor(s) not returning for the run-off will be placed in the lowest position for which he/she was tied, i.e., in a three way tie for first, the exhibitor not returning would receive 3rd place.)

(6) In the case of a run-off, the contestant(s) not winning the run-off cannot be placed lower than the lowest position for which he/she was tied, i.e., 2nd/3rd.

(7) All other ties are not worked off and will involve as many places as there are horses tied, i.e., 4th, 5th, 6th, 7th. The prize money in the previously mentioned example is added together and split equally four ways.

R. SHOW RESULTS

(1) The manager and/or secretary will postmark official documents (show results, original judge's score card, membership applications and other NRHA documents) to the NRHA office within ten (10) days after the last day of the show as required by the rules herein. Show manager and /or secretary will also maintain a copy of show results and maintain the official show entry forms for a period of at least twelve (12) months. Prior to returning to the NRHA office within the ten (10) day requirement, the original judge's sheets must remain in the custody of show secretary for supervision, control, and safekeeping.

(2) Ancillary, Breed Restricted, Affiliate, Entry Level Ride & Slide, Green Level and Adaptive Reining show results must record all riders and horses shown, including scratches, zeros and no scores in the proper placing and be properly labeled. Show results must include membership numbers for all riders and owners/co-owners. Show results must include competition license

numbers for every horse when it is required by show conditions.

Aged Show results must record all money earners in the proper placing. Show results must include membership numbers for all riders and owners/co owners. Show results must include competition license numbers for every horse. Original judges score cards must accompany show results. If show results are submitted incomplete, they will not be accepted and are subject to late fines if complete show results are not submitted within the specified time limit (see section N.4.).

Category 10 show results must record all money and/or point earners in the proper placing. Show results must include membership numbers for all riders. Original judges score cards must accompany show results. If show results are submitted incomplete, they will not be accepted and are subject to late fines if complete show results are not submitted within the specified time limit.

(3) Calculation of the NRHA five percent (5%) retainage shall be the total entry fees, minus the NRHA trophy cost (if an NRHA official trophy is ordered) multiplied by five percent (5%). Shows that require NRHA five percent (5%) retainage to be paid, must submit payment of the five percent (5%) fees with their show results within the timeline stated in this *handbook*.

(4) Shows failing to postmark show results by ten (10) business days following the completion of an NRHA event will be assessed a penalty of \$100. Submitting late show results may jeopardize future NRHA show approvals as determined by the NRHA Executive Committee. An additional penalty of \$500 will be assessed if postmarked after twenty (20) business days. Any results not received by the completion of the NRHA Futurity will not be recognized by the NRHA office.

(5) NRHA approved events will pay back to the current rider, agent, or owner of the horse as recorded with the NRHA the total of the net entry fees, less the show committee's retainage plus the total added money (the full amount of added money must be paid out). Round to the nearest penny when calculating prize money. The contestants will be paid from this pool on a percentage basis depending on placement and number of entries. The payback in all NRHA events (including jackpot classes) will use the appropriate percentage payback schedule provided in the *NRHA Handbook*. Refer to NRHA Worksheet For Paybacks.

(6) Payout to current recorded rider, agent, owner, or responsible party must be made within forty-five (45) days following the completion of the NRHA event. Failure to comply may jeopardize future NRHA approval as determined by the Executive Committee. For events that have been approved for medications testing, NRHA may approve a request, submitted along with show approval, for show management to withhold distribution of purse money earned by horses selected for testing. Pending determination of medications testing, show management of these approved events will receive notification

from NRHA when purse money can be distributed. Show management must distribute purse money within ten (10) days of NRHA's notification. NRHA reserves the right to require an event to withhold distribution of purse money earned by horses selected for testing pending determination of medications testing. Failure to comply may jeopardize future NRHA approval as determined by the Executive Committee.

(7) Youth Class Results: The top 10 youth in each class must be placed and reported on the official show results form. Prize money for added money and jackpot NRHA youth reining classes must be calculated using NRHA Payback Schedule A. The prize money and points must be represented on the show results forms. When calculating youth money, the NRHA plaque cost may not be deducted and the NRHA five percent (5%) office fee is not deducted and is not paid to NRHA. No other type of office fee may be charged to NRHA approved youth classes.

(8) Neither a no score nor a 0 are eligible to place in a go round or single go round class. Neither a no score nor a 0 may advance in a multi-go event. In multi-go events, finals qualifying horses that get a 0 or scratch will still be eligible for payouts, with a 0 placing higher than a scratch. In the event not enough horses qualify for total purse distribution, the undistributed portion of the purse will be retained by show management.

(9) When copying is available, posting judge's score cards is mandatory for NRHA approved classes. Score cards should be posted within one hour of class completion. In the event copies are not an option, judge's score cards must be made available for supervised inspection. Original judge's score cards must remain in the custody of the show secretary for supervision, control, and safekeeping until they are returned to the NRHA office with the show results. Original judge's score cards must be returned to the NRHA office with show results.

(10) A reining will be complete and the posted scores will be considered official thirty minutes following the last horse of the day. Scores must be posted or made available to exhibitors prior to the judge leaving the grounds for the day. Corrections to score cards may not be made at any time after the judge(s) has left the grounds. Corrections to results due to inputting error by show management and/or show program may be made any time.

S. YEAR-END AWARDS

(1) The owners and riders of horses competing in NRHA competition must comply with NRHA membership requirements, being current members in good standing for money earned to count toward year end Top Ten awards.

(2) The earnings are not counted retroactively, only from the day the membership is received in the NRHA office to the end of the award year. All entry information represented on entry forms must accurately state the competition license number for the horse, the current membership number for the rider,

and the current membership number(s) for the owner(s) for Top Ten earnings to count.

(3) A Top Ten record will be kept for each of the following classes:

- | | |
|---------------------------------|---|
| a. Open; | h. Prime Time Non Pro; |
| b. Intermediate Open; | i. Novice Horse Open Level 1; |
| c. Limited Open; | j. Novice Horse Open Level 2; |
| d. Rookie Professional; | k. Novice Horse Non Pro Level 1; |
| e. Non Pro; | l. Novice Horse Non Pro Level 2; |
| f. Intermediate Non Pro; | m. Youth 13 & Under; |
| g. Limited Non Pro; | n. Youth 14–18. |

A Lawson trophy will be awarded to the year-end champion of each class. A Morrison trophy will be awarded to the year-end reserve champion of each class. A pewter trophy will be awarded to top ten places 3–10. Year end awards for the Top Ten standings will be titled NRHA World Champion for the high money earners and youth point earners, NRHA Reserve World Champion for the second high money earners and youth point earners, and NRHA Top Ten for the 3rd–10th top money earners and youth point earners.

(4) The earnings will be awarded on a “one horse—one rider” combination in the Non Pro, Intermediate Non Pro, Limited Non Pro, Novice Horse Non Pro Level 1, Novice Horse Non Pro Level 2, Prime Time Non Pro, and Youth classes.

(5) The earnings will be awarded to the horse in the Open, Intermediate Open, Limited Open, Rookie Professional, Novice Horse Open Level 1, and Novice Horse Open Level 2 classes. The award will be presented to the owner(s) of record at the completion of the NRHA competition year or at the last show at which earnings were recorded for the horse (Open) or horse and rider combination (Non Pro and Youth). (Award and competition year are the same: January 1–December 31.)

(6) NRHA World Champions and Reserve World Champions and Top Ten (3rd–10th) placing horses must have earned money in at least seven (7) NRHA approved shows, in that respective class, to qualify for the title.

(7) The NRHA will also award Certificates of Achievement for all qualifying horses at the end of each year based on cumulative earnings in Category 1. The levels of achievement are:

- | | |
|--------------------------------|----------|
| Certificate of Merit | \$ 2,500 |
| Silver Certificate | 5,000 |
| Gold Certificate | 10,000 |
| Platinum Certificate | 20,000 |

(8) All Top Ten placings and qualifications for year-end awards will be final and not subject to change as of December 31 of that year unless due to disciplinary action as decided on by the Executive Committee.

(9) Affiliates can grant year end trophies in all classes providing those classes were offered in at least 3 shows. Awards will be granted for a combination of one horse/one rider. Champions will be awarded with a pewter trophy and reserve champions with a plaque.

WORKSHEET FOR NRHA PAYBACKS

*In the case of negative net entry fees there is no 5% paid to the NRHA and no show committee retainage. The entire amount of advertised added money will then be paid according to the appropriate payback schedule.

Round to the nearest penny when calculating prize money*

ENTRY FEES X NUMBER OF ENTRIES = GROSS ENTRY FEES (A)

_____ X _____ = _____ (B)

GROSS ENTRY – NRHA TROPHY
FEES OR NRHA PLAQUE FEE
(0 FOR YOUTH)
_____ (A) – _____ = _____ (B)

NRHA FEE OF 5%
(0 FOR YOUTH)
_____ (B) X _____ .05 = _____ (C)
DOLLARS OWED TO
NRHA FOR 5% FEE

DOLLARS PAID TO NRHA = NET ENTRY FEE
FOR 5% FEE (0 FOR YOUTH)
_____ (B) – _____ (C) = _____ (D)

NET ENTRY X % SHOW RETAINAGE = DOLLARS TO
FEE (0 FOR YOUTH) BE RETAINED BY
SHOW COMMITTEE
_____ (D) X _____ = _____ (E)

NET ENTRY – DOLLARS TO BE = FINAL NET ENTRY FEE
FEE RETAINED BY SHOW
_____ (D) – _____ (E) = _____ (F)

FINAL NET + ADDED MONEY = PURSE FROM
ENTRY FEE WHICH PAYBACKS
ARE FIGURED
_____ (F) + _____ = _____

NATIONAL REINING HORSE YOUTH ASSOCIATION BYLAWS

ARTICLE I. NRHyA MISSION STATEMENT

To provide a character and leadership building program that will enable youth to become better citizens and future leaders of the reining horse industry.

ARTICLE II. TITLE, OBJECTIVES, LOCATION

Section 1. Title. This organization shall be called the National Reining Horse Youth Association (NRHyA) and will serve as a division of the National Reining Horse Association, and shall operate within *NRHA Handbook* Bylaws, Rules and Regulations.

Section 2. Objectives. The objectives and purposes of the NRHyA shall be as follows:

- (a) To promote the sport of Reining.
- (b) To improve and develop the capabilities of youth members, both individually and through group participation.
- (c) To develop leadership skills, scholarship opportunities, and participation in the sport of Reining.
- (d) To establish a means whereby youth members may work in conjunction with the NRHA Board of Directors.
- (e) To acquaint youth members and affiliates with the structures and functions of the NRHyA.

Section 3. Place of Business. The place of business of the association shall be the NRHA headquarters in Oklahoma City, Oklahoma.

ARTICLE III. NRHyA EXECUTIVE COMMITTEE

Section 1. The officers of the organization shall be the President, Corresponding Vice President, Secretary, Treasurer, and Historian, who shall be elected at the annual meeting from those selected as regional delegates or existing Officers. Such officers shall hold office for a period of one year and/or their successors are elected or qualified. Officers and Delegates must be eighteen (18) years of age or younger as of January 1 of the year they are elected to serve.

ARTICLE IV. ELECTION OF OFFICERS

Section 1. Regional Elections: Two (2) Regional Delegates: a minimum of one (1) 14–18 will be voted in from each region based on a majority vote. All candidates must meet the minimum officer/delegate eligibility requirements set forth yearly by the NRHyA Executive Committee and approved by the NRHA Youth Committee. Existing NRHyA Officers will not be considered Regional Delegates.

Section 2. Officer Elections: NRHyA Executive Committee members must have served as a current or past Regional Delegate or Officer. All candidates must meet the minimum officer/delegate eligibility requirements set forth yearly by the NRHyA Executive Committee and approved by the NRHA Youth Committee. Additionally, all candidates must be a min-

imum of fourteen (14) years of age and no older than eighteen (18) years of age on January 1 of the year they are elected to serve. Youth members will vote for Officers through the ballot process. The election of officers shall be held at a general membership meeting of the Association at the time and place designated by the NRHA Executive Committee. Any youth wishing to serve as President or Vice President must have served a minimum of one year on the NRHyA Executive Committee prior to being elected for President or Vice President.

Section 3. The remaining Regional Delegates will serve in an advisory capacity to the NRHyA Executive Committee.

ARTICLE V. DUTIES OF OFFICERS

Section 1. President: The President shall be the Chief Executive Officer of the association and shall have general supervision of the affairs of the association, subject to the direction of the NRHyA Youth Executive Committee, and shall preside at all meetings of the members and of the NRHyA Executive Committee. The President shall appoint all committees of the association subject to the approval of the Youth Executive Committee. The President shall submit to the members of the meeting a report of the status of the association and its activities during the preceding year. No President may serve two terms unless there is not an eligible candidate. The President shall have other duties and authority as may be prescribed elsewhere in the Bylaws or by the NRHA Youth Committee.

Section 2. Vice President: The Vice President shall have the responsibility of reporting on the activities of the NRHA Youth Executive Committee to the *NRHA Reiner* magazine. The Vice President shall have the responsibility of maintaining order at all meetings of the NRHyA Executive Committee and the membership meetings in accordance with parliamentary procedure, in addition to preparing meeting rooms and facilities for the meeting of the NRHyA Executive Committee. In addition the Vice President shall, in the absence, disability or inability of the President to act, perform the duties and activities of the President.

Section 3. Secretary: The Secretary shall attend all meetings of the NRHyA Executive Committee and shall record all votes taken and the minutes of all proceedings in a secretary's notebook. He or she shall perform like duties for all the committees when requested to do so. The Secretary shall have the principal responsibility to give notice of all meetings of the NRHyA Executive Committee and the members, but this shall not lessen the authority of others to give such notice as provided by the Bylaws. The Secretary shall maintain communication between the NRHyA Executive Committee and the NRHA Youth Program Supervisor, and in the event the Vice President is unable to fulfill his or her duties, in relation to monthly reports to the *NRHA Reiner*, the Secretary will assume those duties.

Section 4. Treasurer: The Treasurer shall be responsible for examining the financial need of projects and the financial needs of the NRHyA and reporting these costs to the NRHyA Executive Committee.

Section 5. Historian: The Historian shall have the responsibility of developing and maintaining a historical record of the NRHyA. The Historian may also be required to fill those duties that may from time to time be assigned by the President.

Section 6. Vacancy: All vacant Offices of the organization shall be filled by the NRHyA Executive Committee from the Regional Delegates for the unexpired term, and those so appointed shall serve until the election and acceptance of their duly qualified successors.

If the office of any regional delegate, one or more, becomes vacant for any reason, the NRHyA Executive Committee may choose a successor or successors as needed, who shall hold office for the unexpired time in respect of which such vacancy occurred. The successors should be nominated by an NRHyA Executive Committee member, NRHA Youth Committee member or apply by submitting a letter of intent to the NRHA Youth Programs Office.

ARTICLE VI. GENERAL GOVERNANCE

Section 1. Powers of the NRHyA Executive Committee. The NRHyA Executive Committee shall have the power and authority to direct the affairs of the organization as they may deem expedient concerning the conduct, management, and activities. Removal of officers, expenditure of money and other details relating to the general purposes of the organization, are subject to the approval of the NRHA Youth Committee and NRHA Executive Committee.

Section 2. The NRHA Youth Committee shall work in conjunction with the NRHA Executive Committee to oversee the affairs of the NRHyA.

Section 3. The NRHyA Executive Committee shall meet whenever and wherever called by direction of the President, NRHA Youth Committee Chairperson, the NRHA Youth Program Supervisor, or four (4) members of the Committee acting jointly, of which meeting the Secretary shall give two (2) days notice, which may be written or electronic, but such notice may be waived by any member. During the interim between annual meetings, or special meetings, the NRHyA Executive Committee is empowered to direct the affairs of the organization.

Section 4. A majority of the NRHyA Executive Committee shall constitute a quorum for the transaction of business, but if at any meeting the NRHyA Executive Committee has less than a quorum present, a majority of those present may adjourn the meeting.

ARTICLE VII. MEMBERSHIP MEETING

Section 1. The annual meeting shall take place as designated

by the NRHA Executive Committee of Directors for the purpose of such business as may be brought before the meeting. Special meetings of the NRHyA Executive Committee may be held at such time and place as may be designated in the notice, whenever called in writing by the direction of the President or by a majority of the NRHyA Executive Committee.

ARTICLE VIII. MEMBERSHIP AND REGIONS

Section 1. Individual Members: Any Youth eighteen (18) years of age or younger as of January 1 who holds a valid NRHA membership card is automatically considered a member of the NRHyA Program.

Section 2. Voting Rights: Any NRHyA member in good standing has the opportunity to vote in NRHyA elections.

Section 3. Membership Fees: (See *NRHA Handbook* Youth Membership and Show Conditions, Section 2)

ARTICLE IX. REMOVAL OF OFFICERS

Section 1. Membership and election to the office of the NRHyA Youth Executive Committee is a privilege, not a right, which may be terminated or refused for cause detrimental to the interest of the organization.

ARTICLE X. AMENDMENTS

The Bylaws of the organization may be amended by following the rules found in Article XV of the *NRHA Bylaws*.

YOUTH SHOW RULES AND REGULATIONS

A. MEMBERSHIP AND SHOW CONDITIONS

(1) Any youth eighteen (18) years of age or younger as of January 1 may become a member of the National Reining Horse Association Youth Program.

(2) Youth membership is available. (See SHOW RULES AND REGULATIONS, A. MEMBERSHIP, (1), (a) Memberships for the current fee.)

(3) Youth membership entitles a youth to show in any NRHA class for which they are eligible. To show in an NRHA Non Pro class, they must obtain an NRHA Youth Non Pro card. Youth may not show in Rookie Professional.

(4) Youth Associate membership entitles a youth to show in Category 10 classes.

(5) All horses shown the Youth 13 & Under and Youth 14–18 classes must be solely and completely owned by one of the following (a) the youth, (b) a member of his or her immediate family (Refer to definition of immediate family as stated in Section B. Non Pro Conditions), or (c) a corporation, partnership or other business entity provided the Youth and/or a member or members of his or her immediate family are the sole and only owners of that business entity and the ownership of that business entity does not change to include non-immediate family members or entities. Ownership will be evidenced by the competition license.

(6) No stallions, monorchid or cryptorchid horses, regardless of age, will be permitted in any youth classes. If the competition license indicates “stallion” for a horse that has been gelded, entry into an NRHA approved youth class requires that a gelding statement form be filed with the show results and the original competition license be submitted to the NRHA office within 30 days of the show date for modification. Failure to comply will result in the forfeiture of earnings and awards. See General Rules and Regulations Section E-Forfeitures.

B. APPROVED YOUTH REININGS

(1) Anyone wishing to sponsor NRHA youth reinings must follow the NRHA show approval procedure as outlined in this *Handbook*. Approval will be awarded on a first come-first serve basis.

(2) There will be no show approval fee for youth reinings held in conjunction with a regular NRHA approved reining. Anyone wishing to host only a youth reining, a \$20 fee will apply as an approval fee.

(3) There will be two classes offered at all Ancillary approved shows, Youth 13 & Under and Youth 14–18. Other available classes that may be offered are Youth 10 & Under Short Stirrup, Unrestricted Youth, and Youth Rookie.

(4) The show committee may purchase the official NRHA plaque through the NRHA office for both classes and must offer a minimum of 1st through 10th place awards in both classes.

Provide for the future of Reining.

Make your donation today!



CORE PROGRAMS

- **Hall Of Fame**

Always remember how far we've come

- **International Development**

There are no boundaries in Reining

- **Youth Development**

Educating the future of Reining

- **Dale Wilkinson Memorial Crisis Fund**

Taking care of our own

- **Research, Development & Education**

Strengthening the sport of Reining

The Reining Horse Sports Foundation (RHSF) is a non-profit organization dedicated to developing and enhancing the sport of Reining worldwide.

Contact: Reining Horse Sports Foundation • 3000 NW 10th St. • Oklahoma City, Oklahoma 73107-5302
Ph. 405-946-7400 • Fax 405-946-8425 • e-mail: rhsf@nrha.com

rhsf.com

(5) Regular youth reinings are those offering a minimum of 10 awards and points only. There will be an entry fee of no more than \$10 in all regular youth reinings for Ancillary shows.

(6) The top ten youth in each class must be placed and reported on the official show results form. Show committees will use the Youth Point Scale provided in the *NRHA Handbook* to compute the number of points issued in a NRHA youth class. Horses entered but not competing (scratched from the class) will not be placed or used in the computation of youth points, but will be used when computing payback.

(7) There will be no judges' fee or office fee in any NRHA youth reinings.

(8) An NRHA youth class may offer no more than \$100 in added money. No show retainage may be taken in jackpotted or added money classes in Ancillary shows.

(9) For added money youth reinings, the entry fee may be no more than ten percent (10%) of the added money per division in Ancillary shows, Aged shows, Closed Aged shows and Breed Restricted shows.

(10) When calculating youth money, the NRHA plaque cost may not be deducted and the NRHA 5% fee is not deducted and is not paid to NRHA.

(11) Prize money for added money and jackpot NRHA youth reining classes must be calculated using NRHA Payback Schedule A. The prize money and points must be represented on the show results forms.

(12) Any of the eleven NRHA patterns will be used in approved youth reinings. Pattern 12 is to be used only with the Youth 10 & Under Short Stirrup class. The Entry Level Ride & Slide Youth Level 1 class may use relaxed patterns. See Entry Level Ride & Slide Level 1 Show Conditions as set forth in the *NRHA Handbook*.

(13) All rules not covered in this section will be covered in the *NRHA Handbook* under Show Rules And Regulations.

C. INCENTIVE AWARDS

(1) The Youth Incentive Program awards will be determined by the number of points a Youth 13 & Under or Youth 14–18 rider earns in Youth classes (excluding Youth 10 & Under Short Stirrup).

(a) These Youth Incentive Program awards will be issued when a youth contestant reaches the following levels: fifty (50) points, two hundred (200) points, four hundred (400) points, six hundred (600) points, eight hundred (800) points, one thousand (1000) points and fifteen hundred (1500) points.

(2) The Short Stirrup Program awards will be determined by the number of points a youth rider earns in the Youth 10 & Under Short Stirrup reining competition. These points will not count toward the Youth Incentive Program.

(a) These Short Stirrup Program awards will be issued when a youth contestant reaches the following levels in NRHA Youth 10 & Under Short Stirrup reining competition: twen-

ty-five (25) points, fifty (50) points, one hundred (100) points, and two hundred (200) points.

D. YEAR-END AWARDS

(1) Year-end awards will be issued in Youth 13 & Under and Youth 14–18.

(2) Awards will be determined by points earned by a “one horse- one rider combination” in that year in NRHA approved youth reinings.

(3) A Lawson Trophy will be awarded to the year-end champion of each class. A Morrison Trophy will be awarded to the year-end reserve champion of each class. A pewter trophy will be awarded to top ten places 3–10.

(4) NRHA Aged Events reinings (Category 2 Reinings) with a youth section involved will not count towards year-end awards.

NRHA YOUTH POINT SCALE

NUMBER OF HORSES SHOWN # OF PLACES

	1	2	3	4	5	6	7	8	9	10+
1	1	2	3	4	5	6	7	8	9	10
2		1	2	3	4	5	6	7	8	9
3			1	2	3	4	5	6	7	8
4				1	2	3	4	5	6	7
5					1	2	3	4	5	6
6						1	2	3	4	5
7							1	2	3	4
8								1	2	3
9									1	2
10										1

Number of horses to be used for computation shall be those horses actually competing; excluding the number of horses entered but scratched from competition.

Neither a no score nor a 0 are eligible to receive points in an NRHA youth class; however, this does not alter the above scale of points for placing.

NATIONAL FEDERATION

A. Category 8 National Federation Approval

(1) The National Reining Horse Association wishes to promote the sport of reining with the approval of FEI/National Federation reining events.

(a) Owners and riders competing in NRHA/NF Dual Approved competition will be required to be members in good standing of the NRHA.

(b) An event must declare its intent to seek approval or recognition to the NRHA by supplying to NRHA the completed Show Approval Form and following the same guidelines as regular NRHA Events. See Show Rules and Regulations.

(c) The NRHA Executive Committee will examine the merits of events requesting approval or recognition. See Show Rules and Regulations.

(d) Monies earned in Approved or Recognized Events will count towards NRHA lifetime earnings.

NRHA SHOW STEWARD

A. STEWARDING PRIVILEGES

(1) Designation as an NRHA approved Steward is a privilege not a right, bestowed by the NRHA Board of Directors, according to procedures formulated by the NRHA. The privilege shall be open to individuals whose experience and expertise, as well as personal character, merits the honor. An individual's conduct as a member, exhibitor and steward and his/her ability must be exemplary. An individual's conduct will be subjected to continuous review.

(2) Approval and Testing:

(a) Applicant must be at least twenty five (25) years of age and must have been an NRHA General member in good standing for at least one calendar year immediately preceding application before he/she can be considered for approval.

(b) Must submit a complete application to NRHA office at least thirty (30) days prior to the school.

(c) New Applicants must submit five (5) letters of recommendations with application from NRHA Certified Show Secretaries, NRHA Judges and/or NRHA Licensed Show Stewards.

(d) Prospective Stewards must attend an NRHA Steward School and upon passing the testing requirements as set forth by NRHA those persons will then have their names submitted to the Board of Directors for consideration for Steward Privileges.

(e) Prospective stewards who have at least one year's previous stewarding experience with an NRHA Alliance organization, National Federation or FEI, may be exempt from the membership and/or letters of recommendation requirements and will be handled on a case by case basis.

(f) All licensed NRHA Stewards must submit to re-testing every two (2) years.

(g) NRHA Judges and National Federation/FEI Reining Stewards are allowed to continue to serve as an NRHA Show Steward for all NRHA approved shows until January 1, 2011. After January 1, 2011, NRHA Judges and National Federation/FEI Reining Stewards will have to become a licensed NRHA Show Steward according to the graduated licensing dates.

(h) Level AA shows will be required to have a licensed Show Steward.

B. GUIDELINES:

(1) Stewards should remain available to judges, exhibitors and management at all times to clarify the application of NRHA rules and investigate any situation where the rules are not upheld.

(2) Stewards are to be available to consult with show management and judges concerning NRHA Rules, but do not have the authority to override decisions made by show management or judges.

(3) Stewards shall conduct themselves in a manner fitting and proper to one afforded the honor of officiating at an NRHA

approved or sponsored event. Any misconduct on the part of the Steward at any NRHA event such as drinking while on duty, the use of abusive language, or any other action unbecoming to one in his/her position either on the grounds or elsewhere during the duration of the show will make him/her subject to a complete and impartial hearing on the cause of the complaint before the appropriate committee or body.

(4) A Steward who undertakes the obligation to officiate at an NRHA sanctioned event is responsible to fulfill that commitment. Should he/she be unable to officiate for any reason, he/she is required to arrange for a suitable, qualified replacement. Stewards are also required to notify the NRHA Office of said change, failure to do so for any reason may result in immediate suspension of Stewarding License.

(5) If an emergency should arise that requires the Show Steward to leave the grounds he/she should appoint a qualified substitute to fulfill the Show Steward duties in his/her absence. Qualified persons include Licensed Show Stewards, NRHA Judges or Certified Show Secretaries not employed at that show.

(6) An NRHA Show Steward should clearly understand that he/she has no authority in connection with the management or the judging of a competition but should be consulted when interpretation of NRHA rules are in question. He/she should immediately report to the appropriate officials any violations of the rules which might impact the show.

(7) Stewards shall not be an exhibitor at any approved event or combination of events at which he/she is the officiating steward or member of the officiating team.

(8) Stewards must always act in the best interest of the NRHA avoiding any circumstances which create a conflict of interest while officiating at any NRHA approved event. Conflicts of interest are subject to review by the NRHA. In the event it is determined that a steward has acted in an official capacity with a conflict of interest, the steward may be removed from the NRHA Licensed Steward list and may be subject to further disciplinary action for unsportsmanlike conduct.

(9) Stewards shall keep in mind that while officiating they are representing the NRHA. It is strongly recommended that stewards dress appropriately so as to favorably represent their position.

(10) Stewards cannot steward the same show more than two (2) years in a row.

(11) Stewards cannot be immediate family of the exhibitors, show management, show secretary or judges at the same competition and may not judge or be a member of show management at the show they are stewarding.

C. DUTIES OF THE SHOW STEWARD INCLUDE BUT ARE NOT LIMITED TO:

(1) Protect the interests of the exhibitors, judges and show management.

- (2) The show Steward must represent all contestants with the show management and judge(s) and will be the sole liaison with said management or judge(s).
- (3) To immediately investigate and act upon any alleged rule violations.
- (4) To immediately report to the show management any misrepresentation or substitution of entry.
- (5) To verify that NRHA rules are followed when changes to the draw are allowed by show management or judges.
- (6) To report to the show management and NRHA any offense or violation of the rules and prefer charges against violators if the violation is not properly handled by the show management.
- (7) To furnish the NRHA with a complete written report as to the conduct of the competition including any offenses or violations of the rules by the competition or any exhibitors within fifteen (15) days after the last recognized day of the competition, on the form furnished by the NRHA. If NRHA does not receive the completed report and/or attachments postmarked or electronically submitted within fifteen (15) days of the close of competition the Steward may receive a letter of reprimand upon the first offense, a second offense in the same competition year may result in a fine of \$100 and a third offense in the same competition year may result in automatic revocation of Steward License until said Steward reapplies and completes the testing requirements for Steward School. If the Steward disputes that the report was not timely filed he/she may appeal in writing to the NRHA within thirty (30) days of receipt of notification letter from the NRHA.
- (8) To make routine inspections of the arena and stable areas and to insure that these areas are maintained in a safe manner for the horses, exhibitors and spectators.
- (9) To insure that the Protest Forms are available for NRHA members during the entire competition.
- (10) To insure that the Show Steward's contact information is made available to spectators during the competition.
- (11) The Show Steward should be knowledgeable of accepted reining schooling practices and should take necessary action should he/she witness or be made aware of misconduct or abuse on the show grounds. The Show Steward must report if he/she observes any horse being abused or if there are actions by the contestant detrimental to the best interest of the NRHA; loud profane language, drunkenness or being under the influence of intoxicants; any unsportsmanlike conduct toward judges, show management or other exhibitors; or any other infraction of NRHA rules.
- (12) Report to the NRHA details of accidents and/or injuries relating to both humans and horses on the official Accident/Injury Report Form provided by the NRHA. In the event of a fatality the NRHA should be notified as soon as possible no later than

the next NRHA business day.

(13) Stewards are required to report no score situations and details of the no score in the official Show Steward Report.

(14) Stewards must report to the NRHA any rider who shows without an exhibitor number or uses the incorrect exhibitor number.

(15) Stewards must retain copies of steward report forms and supporting documentation for a period of one year.

(16) If more than twelve (12) hours per day of stewarding will be required, show management should hire multiple Show Stewards and the Show Steward will be required to report any work over twelve (12) hours to the NRHA.



Sire & Dam



NATIONAL REINING HORSE ASSOCIATION

MARE OWNER/
OFFSPRING BENEFITS
(For NRHA North American Futurity & Derby)

- ★ Reduced Entry Fees
- ★ Delayed Entry for the Futurity

STALLION OWNER BENEFITS

- ★ Cash Awards
- ★ Free Promotion of Your Stallion

For more information, visit nrha.com
or call (405) 946-7400.

Nominate your future champion today!

\$150,000 in Nominator Incentives available each year.



**Nominate weanlings
by December 31**

Save \$1,700 by nominating before December 31 and give your foals the opportunity to win their share of \$2.5 million each year. For more information go to nrha.com.



Learn about North American and European options at nrha.com.

PHOTOGRAPHY BY DAWN BAXSTROM

FREESTYLE REINING

A. GENERAL RULES

- (1) Reining maneuvers originated from moves that a cow horse must use in performing its duties and have been refined to the high level of competition existing today. Freestyle Reining not only provides an opportunity to use these maneuvers creatively, but also to expand them to music by means of choreography. Riders are encouraged to use musical scores which permit them to show the athletic ability of the horse in a crowd appealing way.
- (2) NRHA rules will apply except where the following rules preempt same.
- (3) Required Maneuvers. Will be defined as follows:
 - (a) A minimum of four (4) consecutive spins to the right
 - (b) A minimum of four (4) consecutive spins to the left
 - (c) A minimum of three (3) stops
 - (d) A minimum of one (1) lead change at the canter from right to left
 - (e) A minimum of one (1) lead change at the canter from left to right
- (4) Exhibitors will only be judged astride.
- (5) Exhibitors are allowed to use two (2) hands (as well as one or no hands) and any bit approved by the *NRHA Handbook*, including snaffle bits and bosals approved for use in the Snaffle Bit or Hackamore classes.
- (6) Failure to perform all the required maneuvers or failure to complete the performance within the time limit will result in a score of zero (0).
- (7) Additional maneuvers such as rollbacks, backups, speed variations, and non-classical reining maneuvers such as half pass and side pass are appropriate in Freestyle and shall be given appropriate credit. Additional repetitions of required maneuvers are appropriate, but will only add or subtract from the existing scores already given for the required maneuvers, not as additional scores.
- (8) Equipment used in Freestyle must adhere to the following standards:
 - (a) All equipment must be non-abusive and humane based on NRHA Rules and Guidelines.
 - (b) Any equipment not specifically covered by or in conflict with standard equipment guidelines must be non-abusive to the horse.
- (9) **Time Limit.** A maximum of four (4) minutes including any introductions. The time limit will be from the beginning of the music or from the beginning of the introduction (whichever is first) and will end with the music.
- (10) **Costumes.** Permitted but not required. Emphasis is placed on performing the reining maneuvers to music.

(11) Props. Permitted but at no time may hinder the judges' view of the horse. The use of props will not add to the score.

B. JUDGING OF FREESTYLE REINING

(1) Required maneuvers in Freestyle will receive a score based on technical merit from the technical judges utilizing judges score cards specifically designed for the Freestyle. Transitional maneuvers and other maneuvers not specified as reining maneuvers will be evaluated and scored accordingly in a specified box and counted as a single maneuver score. If an artistic impression judge is used, they must use the score sheet provided by NRHA and are encouraged to include remarks regarding performance. In the event an artistic judge is not used, the technical judges will assess an artistic impression score in the box specified using a -2 (two) to a +2 (two) evaluation. (See Figure #9.)

(2) Number of Judges. Two or more NRHA approved judges must be used in any Freestyle class that offers \$2,000 or more in added money.

(3) In the case of one or two (2) judges being used, they would be required to be NRHA approved. They would judge the technical merit of the ride. As part of the overall score, each judge would weigh the artistic impression of the ride as 10 percent of the overall ride.

(4) Tie Breaker Judge. One (1) judge (not to be an artistic impression judge) shall be designated as the tiebreaker prior to the Freestyle class. In the event a tie still occurs (or the tie occurs with one judge), the technical merit scores will be tallied to break the tie. In the event a tie remains, the exhibitors tied will be declared co-champions.

(5) Validating required maneuvers will be the responsibility of the judges. However, at least one scribe will be used to assist in verifying the required maneuvers for each horse as they are completed in the pattern.

(6) All five (5) point penalties may apply except holding the saddle or saddle horn with either hand, which is allowed.

(7) Eliminations are to be used at the discretion of show management and must use NRHA patterns, NRHA judging rules as applied to Category 1 classes, and NRHA judges. Eliminations may be held without music or costuming, but must allow the use of either one (1) or two (2) hands. The emphasis in the design of any elimination should be on quality of competition.

(8) Artistic impression judge or applause meter should not represent more than twenty percent (20%) of the combined score and should only be used in conjunction with (minimum) two NRHA approved judges. When used in scoring, the following formulas should be applied to properly weigh the scores according to the above percentage and still produce a comparable numerical score as when three judges are used.

(a) Score for Judge 1 should be multiplied by 1.2

(b) Score for Judge 2 should be multiplied by 1.2

(c) Score for the Applause Meter should be multiplied by .6.

All three scores should then be added to determine the final score for placing.

(9) Freestyle Reining may offer both an Open and a Non Pro Freestyle class. Show management will reserve the right to run them concurrently or separately.

(10) Show management will reserve the right to rule on music or dress which may be inappropriate or offensive to the spirit and nature of the show. Show management may also determine the use of special lighting.



DALE WILKINSON

MEMORIAL CRISIS FUND

The NRHA Hall of Fame's first inductee and without question one of Reining's most well-respected iconic legends, Dale Wilkinson was often referred to as the "Father of Modern-Day Reining." Sadly, Dale passed away in 2010. His wisdom, passion and knowledge for the sport of Reining will be greatly missed.

Help us grow the Dale Wilkinson
Memorial Crisis Fund today.

Your donation can help provide financial support for Reiners who have experienced catastrophic events. The RHSF and Dale Wilkinson's family thank you for your loving support.

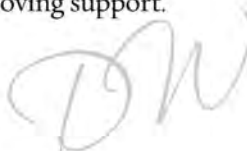

For more information contact the
Reining Horse Sports Foundation at
rhsf@nrha.com or 405-946-7400 • rhsf.com

JUDGES

A. JUDGING PRIVILEGES

(1) Designation as an NRHA approved judge is a privilege, not a right, bestowed by the NRHA Board of Directors, according to procedures formulated by the Judges Committee. This privilege shall be open to individuals whose equine experience and expertise, as well as personal character, merits the honor. An individual's conduct as a member, exhibitor, and judge, and his or her ability must be exemplary. An individual's conduct will be subjected to continuous committee review.

(2) Approval and Testing:

(a) A prospective judge must attend an NRHA Applicant Seminar and upon passing the testing requirements as set forth by the Judges Committee will be eligible to attend an NRHA Judges School. Upon passing the testing requirements of an NRHA Judges School as set forth by the Judges Committee, those persons will then have their names submitted to the Board of Directors for consideration for judging privileges.

(b) The applicant must be at least twenty-five (25) years of age and must have been an NRHA General member in good standing for 24 months prior to the date of application before he or she can be considered for approval as an NRHA judge.

(c) Approved judges and prospective judges must be current NRHA members.

(d) All approved NRHA judges must submit to re-testing every two (2) years.

(e) The NRHA Judges Committee may, on reasonable notice, require any current judge to submit to a Judges School and re-test. Failure to comply or failure to pass the test will result in the immediate suspension of judging privileges.

B. JUDGES COMMITTEE

(1) The NRHA President will appoint a Judges Committee Chairperson. The Chairperson will then appoint the committee members. It shall be the duty of the Judges Committee to administer judges' tests, conduct seminars, may review any and all judging after NRHA sponsored events or approved events, and review judging performances on recommendation of show representatives or by official protest. The Committee shall be empowered to take all action necessary to improve the quality, integrity and performance of the judging system.

(2) The Judges Committee, upon receipt of information which adversely affects a person's ability to be a judge, may temporarily suspend a judge's privileges pending a hearing before the NRHA Executive Committee. The Board of Directors shall have the authority, with or without the recommendation of the Judges Committee, to discipline, penalize, and/or remove a judge's name from the approved judges list.

(3) Performance reviews may be requested through the Judges

Evaluation and Education Program (JEEP). All reviews performed through the JEEP system are non punitive in nature and will be used for the education and improvement of NRHA judges. Reviews will be contingent upon the availability of official show video. Non approved classes or events will not be evaluated and the Judges Committee has the right to deny a request for review. Parties requesting the review do not receive the results of the review unless it is a review of one's own judging performance.

C. GUIDELINES

(1) A horse may not be shown under a judge if that judge has been owner, exhibitor, trainer, or agent of that horse within the previous ninety (90) days or if said horse is ridden by a member of his/her immediate family or by an employee/employer of said judge. A judge may not show to another judge whom he/she has judged or judged with within five days nor may a judge judge another judge to whom he/she has shown or judged with within five days. Volunteer NRHA judges utilized for equipment inspection are excluded from the five day requirement. A judge is responsible for disclosing an agency relationship as soon as he/she becomes aware of the problem to the show representative/steward if a horse is exhibited not in compliance with this rule. The judge should notify the show representative/steward or show management of the non-compliance at the next break, drag, or prior to the class being placed. The exhibitor should not be counted as an entry, and the horse shall not be scored in the class. All parties involved including but not limited to the owner, exhibitor, and judge will be held responsible in the event non-compliance occurs. The Judges Committee will investigate the matter and handle in accordance with its findings and consistent with NRHA disciplinary rules.

(2) Individuals who have an ongoing (regular, continuous, or contractual) business relationship within ninety (90) days in which services are provided and fees and costs are incurred shall not judge or be judged by each other. This applies to both exhibitor and owner.

(3) A judge shall not be an exhibitor at any NRHA approved event or combinations of events at which he or she is the officiating judge or member of the officiating team. Volunteer NRHA judges utilized for equipment inspection are excluded.

(4) Judges must always act in the best interest of the National Reining Horse Association avoiding any circumstances which create a conflict of interest while officiating at any NRHA approved event. Conflicts of interest are subject to review by the Judges Committee. In the event it is determined that a judge has acted in an official capacity with a conflict of interest, the judge may be removed from the NRHA Judges list and may be subject to further disciplinary action for unsportsmanlike conduct.

(5) Judges shall keep in mind that while judging they are representing the NRHA. It is strongly recommended that judges

- dress appropriately so as to favorably represent their position.
- (6) It is recommended that a judge shall not appear on the show grounds more than one hour prior to the scheduled start of the show unless as directed or requested by show management. Judges shall not visit with owners, trainers, exhibitors or agents before or during an NRHA approved event. The judges shall talk only with representatives of show management, beyond the exchange of normal greetings, until the entire show or contest is completed. (An exception occurs for Category 10 classes where judges are allowed to talk to exhibitors in an open forum prior to and/or following the event. After each class or event judges may provide feedback to exhibitors on an individual basis. These discussions with exhibitors should be monitored by someone appointed by show officials).
- (7) A judge (or judges) must present in writing any grievance within ten (10) days of the incident that he/she may have against contestants or shows to an Official Officer, Director, or duly elected or appointed contestant's representative of the NRHA at the time of the grievance. The judge is not required to post the \$100 grievance fee. His/her case will be reviewed by the appropriate committee and dealt with in accordance with the disciplinary procedures section of the handbook. If any of the above named officials witness a grievance against a judge, he or she must report this immediately to the NRHA office. Said report must be in writing and must be accompanied by the \$100 protest fee. Any grievance concerning a judge's conduct must be filed within ten (10) days of having gained knowledge of the incident. All grievances will be dealt with in accordance with the disciplinary procedure of the *handbook*.
- (8) A judge shall conduct himself/herself in a manner fitting and proper to one afforded the honor of officiating at any NRHA approved or sponsored event. Any misconduct on the part of the judge at any NRHA contest such as drinking immediately prior to or during the contest, the use of abusive language, or any other action unbecoming to one in his/her position either on the grounds or elsewhere during the duration of the show will make him/her subject to a complete and impartial hearing on the cause of the complaint before the appropriate committee.
- (9) A judge who undertakes the obligation to officiate at an NRHA sanctioned event is responsible to fulfill that commitment. Should he/she be unable to officiate for any reason, he/she is required to arrange for a suitable, qualified replacement. Judges are also required to notify the NRHA office of said change. Failure to do so, for any reason, will result in immediate suspension of judging privileges.
- (10) NRHA judges who judge unapproved reining classes will be subject to an Investigative Judge Review. The following exceptions exist where judge(s) may judge unapproved reining classes:
- (a) classes that do not coincide with NRHA classes and therefore cannot be approved by NRHA

- (b)** beginner or green classes
- (c)** affiliate level classes that are held concurrent with NRHA approved classes
- (d)** shows with less than \$500-added money
- (e)** breed association classes [Jr., Sr., Amateur, and Youth breed classes]
- (f)** National Federation or FEI events
- (g)** shows held by an NRHA breed association affiliate and/or affiliated discipline association



DIGITAL REINER MAGAZINE

Now everyone can read the
NRHA Reiner magazine
online at NRHA.com—**FREE!**

WITH EMAIL AND WEBSITE LINKS,
AND MORE.

PROMOTING
YOUR BUSINESS TO REINERS,
JUST GOT EASIER!

CALL TODAY FOR ADVERTISING INFORMATION AND OPPORTUNITIES.

Sharon Barr • 419-628-3711

Chris Maedche • 505-865-7050

—Or in Europe—

Simona Diale • +39-340 5354629 or
+39-0143849139

REINER
YOUR WORLDWIDE
SOURCE FOR REINING

Notes

RULES FOR JUDGING

A. GENERAL

To rein a horse is not only to guide him, but also to control his every movement. The best reined horse should be willingly guided or controlled with little or no apparent resistance and dictated to completely. Any movement on his own must be considered a lack of control. All deviations from the exact written pattern must be considered a lack of/or temporary loss of control and therefore a fault that must be marked down according to severity of deviation. After deducting all faults, set here within, against execution of the pattern and the horse's overall performance, credit should be given for smoothness, finesse, attitude, quickness and authority of performing various maneuvers, while using controlled speed which raises the difficulty level and makes him more exciting and pleasing to watch to an audience. The official guideline for the application for the rules for judging shall be as specified in the NRHA Judges Guide.

B. SCORING

(1) The scoring will be on a basis of zero (0) to Infinity, with seventy (70) denoting an average performance. The individual maneuvers are scored in one-half ($\frac{1}{2}$) point increments from a low of $-1\frac{1}{2}$ (one and one-half) to a high of $+1\frac{1}{2}$ (one and one-half) with a score of zero (0) denoting a maneuver that is correct with no degree of difficulty. Scores will be announced after each horse works.

(2) **TIES** All ties for 1st place will be worked off if the tied exhibitors agree to participate in a run-off. Tied exhibitors have the alternate option of agreeing not to run-off and to be named co-champions but must determine the winner of the awards by a flip of a coin. If they do not agree, the exhibitor(s) who does not want to run-off will forfeit first place to the other. (Exceptions: Freestyle reining. See Freestyle Reining conditions to determine winner or co-champions; Category 2 Snaffle Bit or Hackamore classes—a run-off is not required for 1st place.)

If a tie occurs after the run-off, the entrants will be named co-champions; will evenly split 1st and 2nd prize money, but must determine the winner of the awards by a flip of a coin. A horse not returning for a run-off without such an agreement will forfeit 1st place prize money regardless of the added money. In the case of a run-off, the contestant(s) not winning the run-off cannot be placed lower than the lowest position for which he/she was tied, i.e., 2nd/3rd. All other ties are not worked off and will involve as many places as there are horses tied, i.e., 4th, 5th, 6th, 7th. The prize money in the previously mentioned example is added together and split equally-four ways.

(3) Equipment:

(a) References to hackamore mean the use of a flexible, braided, rawhide, leather, or rope bosal, the core of which

may be either rawhide or flexible cable with a maximum diameter of 3/4" at the cheek. Absolutely no rigid material will be permitted under the jaws or on the noseband in connection with the bosal, regardless of how padded or covered. Horsehair bosals are prohibited. This rule does not refer to the so-called mechanical hackamore which is illegal.

(b) References to snaffle bits mean conventional O-ring, egg-butt, or D-ring with a ring no larger than 4" and no smaller than 2". The inside circumference of the ring must be free of rein, curb or headstall attachments which would provide leverage. The mouthpiece should be round, oval or egg-shaped, smooth and free of wire. It may be inlaid, but smooth and/or latex wrapped. The bars must be a minimum of 5/16" in diameter, measured 1" in from the cheek with a gradual decrease to center of the snaffle. Optional curb strap is acceptable however curb chains are not acceptable. These requirements remain the same for all classes in which a rider may use a snaffle bit.

(c) References to a bit means the use of a curb bit that has a solid or broken mouthpiece, has shanks and acts with leverage. All curb bits must be free of mechanical device and should be considered a standard western bit. A standard western bit includes:

1. 8½" maximum length shank to be measured as indicated in the judge's guide. Shanks may be fixed or loose.
2. Concerning mouthpieces, bars must be round, oval or egg-shaped, smooth and free of wire of 5/16" to 3/4" in diameter, measured 1" from the cheek. They may be inlaid, but must be smooth or latex wrapped. Nothing may protrude more than 1/8" below the mouthpiece (bar).
3. The port must be no higher than 3½" maximum, with rollers and covers acceptable. Broken mouthpieces, half-breeds, and spades are standard.
4. Slip or gag bits, donuts or flat polo mouthpieces are not acceptable.

(d) Only one hand may be used on the reins and the hand must not be changed, except in the Snaffle Bit, Freestyle, Green and Entry Level Ride & Slide Level 1 classes which allow the use of two hands. Index finger only between split reins is permitted. Violation of this rule results in a penalty score of zero (0).

(e) When a curb bit is used, a curb strap or curb chain is required, which must be at least ½" in width, lie flat against the jaw, and be free of barbs, wire, and/or twists.

(4) The following will result in no score:

(a) infraction of any state or federal law which exists pertaining to the exhibition, care, and custody of horses within the state or country where an NRHA Reining is being held;

(b) abuse of an animal in the show arena and/or evidence that an act of abuse has occurred prior to or during the exhibition of a horse in competition;

(i) if the judge(s) determines paint or other substance has been applied to a horse to disguise abuse he/she may call a no score. Excessive use of paint or color substance may result in a no score.

(c) use of illegal equipment, including wire on bits, bosals or curb chains;

(d) use of illegal bits, bosals or curb chains;

(e) use of tack collars, tie downs or nose bands;

(f) use of whips or bats;

(g) use of any attachment which alters the movement of or circulation to the tail;

(h) failure to dismount and/or present horse and equipment to the appropriate judge for inspection;

(i) In any approved class, the judge shall have the authority to require the removal or alteration of any piece of equipment or accoutrement which is unsafe, or in his/her opinion, would tend to give a horse an unfair advantage or which he/she believes to be inhumane;

(j) disrespect or misconduct by the exhibitor;

(k) the judge(s) may excuse a horse at any time while in the arena for unsafe conditions or improper exhibition pertaining to both the horse and/or rider;

(l) closed reins are not allowed except as standard romal reins and mecates on snaffle bits and bosals in classes where the use of two hands is allowed and in the Youth 10 & Under Short Stirrup class where closed reins are allowed.

(5) Excess rein may be straightened at any place a horse is allowed to be completely stopped during a pattern. When using a romal, the rider's hand shall be around the reins with the wrist kept straight and relaxed, the thumb on top and the hand closed around the reins; no fingers between the reins are allowed. The free hand may be used to hold the romal provided it is held in a relaxed position and there is at least 16" of romal from the free hand to the reining hand. Use of the free hand while holding the romal to alter the tension or length of the reins from the bridle to the reining hand is considered to be the use of two hands, and a score of zero (0) will be applied with the exception of any place a horse is allowed to be completely stopped during a pattern.

(6) The following will result in a \$25 fine:

(a) Failure to display exhibitor number or displaying incorrect exhibitor number

(7) The following will result in a score of zero (0):

(a) use of more than index or first finger between reins;

(b) use of two (2) hands (exception in Snaffle Bit, Hackamore, NRHA Green or Ride & Slide Level 1 classes designated for two hands) or changing hands;

- (c) use of romal other than as outlined in #5;
- (d) failure to complete pattern as written;
- (e) performing the maneuvers other than in specified order;
- (f) the inclusion of maneuvers not specified, including, but not limited to

1. backing more than two (2) strides
2. turning more than ninety (90) degrees
3. On run in patterns, once beginning a canter a complete stop prior to reaching the first marker.

(Exception: a complete stop in the 1st quarter ($\frac{1}{4}$) of a circle after a canter departure is not to be considered an inclusion of maneuver; a two (2) point break of gait penalty will apply.) (See Figure #3B)

- (g) equipment failure that delays completion of pattern;
- (h) balking or refusal of command where performance is delayed;
- (i) running away or failing to guide where it becomes impossible to discern whether the entry is on pattern;
- (j) jogging in excess of one-half ($\frac{1}{2}$) circle or one-half ($\frac{1}{2}$) the length of the arena;
- (k) over spins of more than one quarter ($\frac{1}{4}$) turn;
- (l) fall to the ground by horse or rider. A horse is deemed to have fallen when its shoulder and/or hip and/or underline touches the ground;
- (m) dropping a rein that contacts the ground while the horse is in motion;
- (n) failure to wear appropriate western attire as outlined in the *NRHA Handbook*, General Show Conditions.

NOTE: Neither a no score nor a zero (0) is eligible to place in a go round nor single go round class. Neither a no score nor a zero (0) may advance in a multi-go event. In multi-go events, finals qualifying horses that get a zero (0) or scratch will still be eligible for payouts, with a zero (0) placing higher than a scratch. In the event not enough horses qualify for total purse distribution, the undistributed portion of the purse will be retained by show management.

(8) The following will result in a penalty of five (5) points:

- (a) spurring in front of cinch;
- (b) use of either hand to instill fear or praise;
- (c) holding saddle with either hand, except in the Youth 10 & Under Short Stirrup class where holding the saddle is allowed;
- (d) blatant disobedience including kicking, biting, bucking, rearing and striking.

(9) The following will result in a two (2) point penalty:

- (a) break of gait; Note: Simple lead changes are allowed in NRHA Green classes, no break of gait penalty should be applied during the lead change. NRHA Ride & Slide Level 1 classes may use altered patterns and if simple lead changes are specified, no break of gait penalty

should be applied during the lead changes.

(b) freezing up in spins or rollbacks;

(c) on walk in patterns, cantering prior to reaching the center of the arena and/or failure to stop or walk before executing a canter departure;

(d) on run in patterns, failure to be in a canter prior to reaching the first marker or break of gait prior to the first marker.

(e) if a horse does not completely pass the specified marker before initiating a stop position.

(10) Starting or performing circles or eights out of lead will be judged as follows:

(a) Each time a horse is out of lead, a judge is required to penalize by one (1) point. The penalty for being out of lead is cumulative, and the judge will add one (1) penalty point for each one quarter ($\frac{1}{4}$) of the circumference of a circle or any part thereof that a horse is out of lead.

(b) A judge is required to penalize a horse one half ($\frac{1}{2}$) of a point for a delayed change of lead by one (1) stride where the lead change is required by the pattern description.

(11) Deduct one half ($\frac{1}{2}$) point for starting circle at a jog or exiting rollbacks at a jog up to two (2) strides. Jogging beyond two (2) strides but less than one half ($\frac{1}{2}$) circle or one half ($\frac{1}{2}$) the length of the arena, deduct two (2) points.

(12) Deduct one half ($\frac{1}{2}$) point for over or under spinning up to one eighth ($\frac{1}{8}$) of a turn; deduct one (1) point for over or under spinning up to one quarter ($\frac{1}{4}$) of a turn.

(13) In patterns requiring a run-around, failure to be on the correct lead when rounding the end of the arena will be penalized as follows: for one half ($\frac{1}{2}$) the turn or less, 1 point; for more than one half ($\frac{1}{2}$) turn, two (2) points.

(14) There will be a one half ($\frac{1}{2}$) point penalty for failure to remain a minimum of twenty (20) feet from the side of the arena when approaching a stop and/or rollback.

(15) Judges may not confer on any penalty or maneuver score prior to submitting a score. If a major penalty (a penalty which results in a no score, a zero (0), or a five (5) point penalty) is unclear, a judge will submit his/her score and ask that the score be held, pending a conference or review of the official video at the next drag or as soon as practical. Should the judges determine via conference or video replay that a penalty was incurred, it should be applied. If, however, no penalty occurred, the score will be announced as originally submitted. No judge shall be required to change his/her score following a conference or video replay. Each judge's decision is an individual call and based on individual decision from a conference or video replay. The use of video equipment by the judges is only permissible if the judge has reason to believe that all entries have been videotaped.

(16) The judge shall have the authority to remove any

contestant from a show he is judging, should said contestant show any disrespect or misconduct so as to render himself or the show in an unprofessional manner.

(17) All riders must dismount and the horse must be presented and the bridle dropped by the rider or a designated representative. The horse and equipment must be checked by the designated judge in the arena or in close proximity to the arena during a pre- or post-check. Should the equipment judge detect cause for a no score the exhibitor or his/her representative, trainer or guardian may at that time accept the no score and allow the equipment judge to cause the appropriate changes to all score cards or request the other judges confer on the appropriate call. In the case of a youth exhibitor, should a parent, trainer or guardian not be present, it will be assumed that all parties are aware of this rule and agree to abide by the exhibitor's decision. If requested, the equipment judge will confer with the other judges as soon as practical. Failure to comply with this rule shall result in a no score.

(18) Judges shall be the sole persons responsible to determine if a rider has correctly completed the pattern as written.

(19) An exhibitor or owner in the respective class may request a review of a major penalty (penalty score zero (0) and five (5) point penalty). The judge(s) has the right to deny or honor the request. If honored by the judge(s) he/she must believe the entire class was videotaped by an official videographer. The request must be made no later than thirty (30) minutes after the last run of the day and before the judge(s) has left the grounds for the day. Exhibitors or owners may not have direct contact with the judge(s) during the entire process of requesting a review. The request must be submitted to the Show Steward, Show Representative, or if need be Show management who will take the request to the judge(s).

(20) NRHA permits the judge the option of awarding a re-ride if an unavoidable circumstance disrupts a horse and rider's pattern. In the instance where a re-ride is warranted in the judge's opinion, the judge should advise the NRHA Representative, Steward, and/or horse show management of such as soon as possible. In the case where a horse was able to complete the pattern, but a re-ride is warranted, the score should be held until the rider decides whether to exercise the re-ride option.

(21) The NRHA Judges Committee will evaluate individual requests from challenged riders regarding the use of aids when exhibiting. In the event an individual is granted special privileges, he or she will be presented said privileges in writing and must provide a copy to the show committee each time he or she exhibits. The Show Committee is required to present said privileges to the Judge(s) as well as the individual's draw number and exhibitor number prior to the class in which he or she will be competing.

PATTERNS

1. The following patterns are to be worked as stated, not as drawn. The drawn pattern is just to give the general idea of what the pattern will look like in the arena.
2. Markers will be placed on the wall or fence of the arena as follows:
 - (i) at the center of the arena
 - (ii) at least 50' (15 meters) from each end wall
3. Where designated in the pattern for stops to be beyond a marker, the horse should begin his stop after he passes the specified marker.
4. Each pattern is drawn so that the bottom of the page represents the end of the arena entered by contestants and must be run as such. In the event that an arena has only one gate and it is in the exact middle of the side, that side shall represent the right side of the page the pattern is drawn on.
5. All horses will be judged immediately upon entering the arena and judging will cease after the last maneuver. Any fault incurred prior to the commencement of a pattern will be scored according to the rules for judging.
6. All judges' decisions are final.
7. With the exception of Entry Level Ride & Slide Level 1 classes, the following patterns are the only patterns to be used at NRHA events. NRHA Green classes should use NRHA patterns but simple lead changes are allowed.

PATTERNS TO FOLLOW, INDICATES MARKERS

Pattern 1

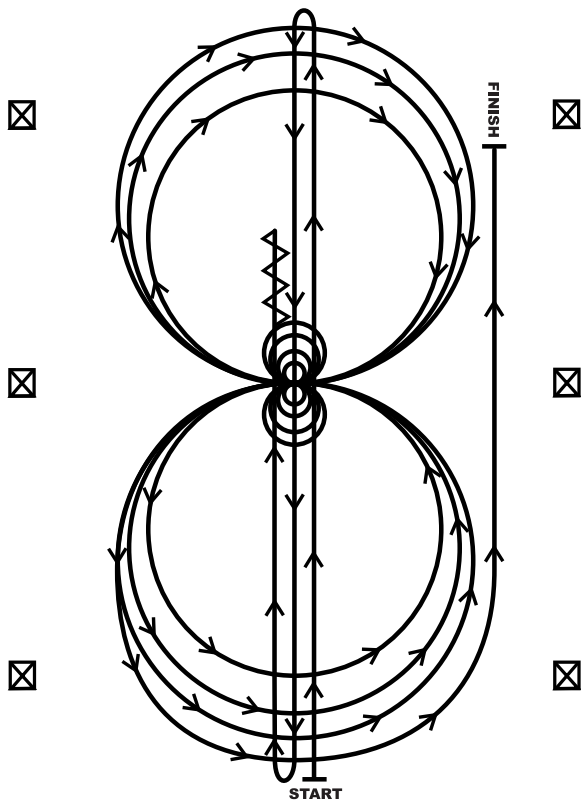

Pattern 1

- 1.** Run at speed to the far end of the arena past the end marker and do a left rollback—no hesitation.
- 2.** Run to the opposite end of the arena past the end marker and do a right rollback—no hesitation.
- 3.** Run past the center marker and do a sliding stop. Back up to center of the arena or at least ten feet (three meters). Hesitate.
- 4.** Complete four spins to the right. Hesitate.
- 5.** Complete four and one-quarter spins to the left so that horse is facing left wall or fence. Hesitate.
- 6.** Beginning on the left lead, complete three circles to the left: the first circle large and fast; the second circle small and slow; the third circle large and fast. Change leads at the center of the arena.
- 7.** Complete three circles to the right: the first circle large and fast; the second circle small and slow; the third circle large and fast. Change leads at the center of the arena.
- 8.** Begin a large fast circle to the left but do not close this circle. Run straight up the right side of the arena past the center marker and do a sliding stop at least twenty feet (six meters) from wall or fence. Hesitate to demonstrate the completion of the pattern.

Pattern 2

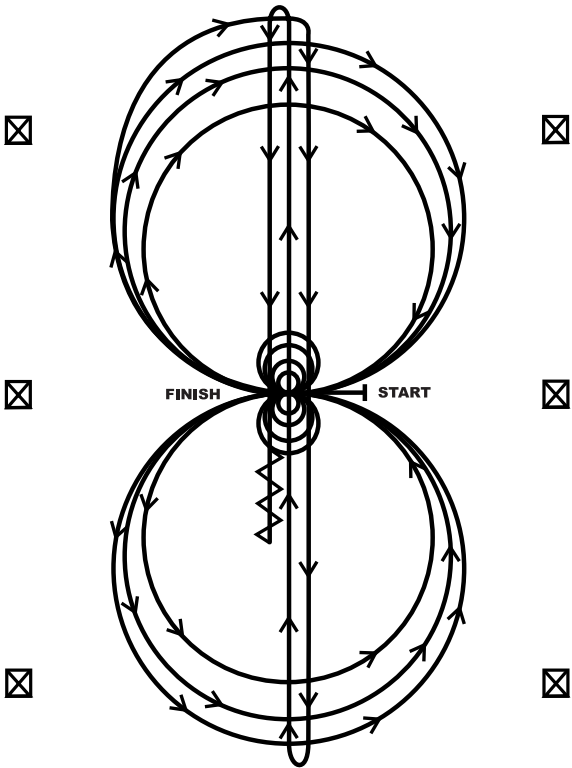

Pattern 2

Horses may walk or trot to the center of arena. Horses must walk or stop prior to starting pattern. Beginning at the center of the arena facing the left wall or fence.

1. Beginning on the right lead, complete three circles to the right: the first circle small and slow; the next two circles large and fast. Change leads at the center of the arena.
2. Complete three circles to the left: the first circle small and slow; the next two circles large and fast. Change leads at the center of the arena.
3. Continue around previous circle to the right. At the top of the circle, run down the middle to the far end of the arena past the end marker and do a right rollback—no hesitation.
4. Run up the middle to the opposite end of the arena past the end marker and do a left rollback—no hesitation.
5. Run past the center marker and do a sliding stop. Back up to the center of the arena or at least ten feet (three meters). Hesitate.
6. Complete four spins to the right. Hesitate.
7. Complete four spins to the left. Hesitate to demonstrate the completion of the pattern.

Pattern 3

- 1.** Beginning, lope straight up the left side of the arena, circle the top end of the arena, and staying at least twenty feet (six meters) from the walls or fence, run straight down the opposite or right side of the arena past the center marker and do a left rollback—no hesitation.
- 2.** Continue straight up the right side of the arena circle back around the top of the arena, and staying at least twenty feet (six meters) from the walls or fence, run straight down the left side of the arena past the center marker and do a right rollback—no hesitation.
- 3.** Continue up the left side of the arena to the center marker. At the center marker, the horse should be on the right lead. Guide the horse to the center of the arena on the right lead and complete three circles to the right: the first two circles large and fast; the third circle small and slow. Change leads at the center of the arena.
- 4.** Complete three circles to the left: the first two circles large and fast; the third circle small and slow. Change leads in the center of the arena.
- 5.** Begin a large fast circle to the right but do not close this circle. Continue up the left side of the arena, circle the top of the arena, and staying at least twenty feet (six meters) from the walls or fence, run straight down the opposite or right side of the arena past the center marker and do a sliding stop. Back up at least ten feet (three meters). Hesitate.
- 6.** Complete four spins to the right. Hesitate.
- 7.** Complete four spins to the left. Hesitate to demonstrate completion of the pattern.

Pattern 4

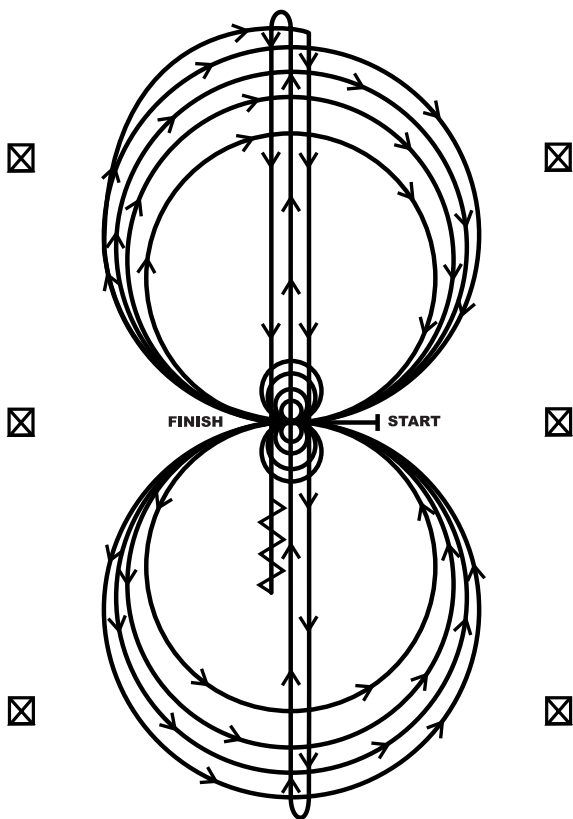

Pattern 4

Horses may walk or trot to the center of the arena. Horses must walk or stop prior to starting pattern. Beginning at the center of the arena facing the left wall or fence.

1. Beginning on the right lead, complete three circles to the right: the first two large and fast; the third circle small and slow. Stop at the center of the arena. Hesitate.
2. Complete four spins to the right. Hesitate.
3. Beginning on the left lead, complete three circles to the left: the first two circles large and fast; the third circle small and slow. Stop at the center of the arena. Hesitate.
4. Complete four spins to the left. Hesitate.
5. Beginning on the right lead, run a large fast circle to the right, change leads at the center of the arena, run a large fast circle to the left, and change leads at the center of the arena. (Figure 8)
6. Continue around previous circle to the right. At the top of the circle, run down the middle to the far end of the arena past the end marker and do a right rollback—no hesitation.
7. Run up the middle to the opposite end of the arena past the end marker and do a left rollback—no hesitation.
8. Run past the center marker and do a sliding stop. Back up to the center of the arena or at least ten feet (three meters). Hesitate to demonstrate completion of the pattern.

Pattern 5

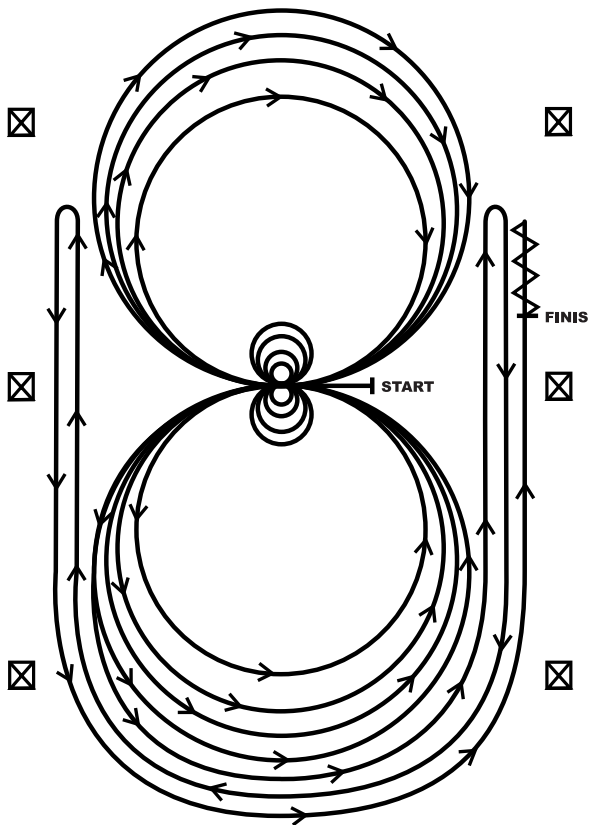

Pattern 5

Horses may walk or trot to the center of arena. Horses must walk or stop prior to starting pattern. Beginning at the center of the arena facing the left wall or fence.

1. Beginning on the left lead, complete three circles to the left: the first two circles large and fast; the third circle small and slow. Stop at the center of the arena. Hesitate.
2. Complete four spins to the left. Hesitate.
3. Beginning on the right lead, complete three circles to the right: the first two circles large and fast; the third circle small and slow. Stop at the center of the arena. Hesitate.
4. Complete four spins to the right. Hesitate.
5. Beginning on the left lead, run a large fast circle to the left, change leads at the center of the arena, run a large fast circle to the right, and change leads at the center of the arena. (Figure 8)
6. Continue around previous circle to the left but do not close this circle. Run up the right side of the arena past the center marker and do a right rollback at least twenty feet (six meters) from the wall or fence—no hesitation.
7. Continue around previous circle but do not close this circle. Run up the left side of the arena past the center marker and do a left rollback at least twenty feet (six meters) from the wall or fence—no hesitation.
8. Continue back around previous circle but do not close this circle. Run up the right side of the arena past the center marker and do a sliding stop at least twenty feet (six meters) from the wall or fence. Back up at least ten feet (three meters). Hesitate to demonstrate completion of the pattern.

Pattern 6

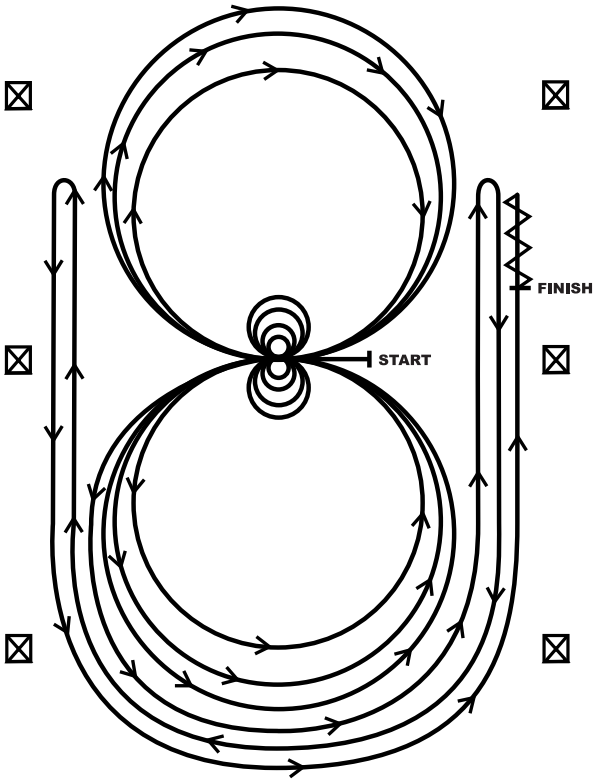

Pattern 6

Horses may walk or trot to the center of arena. Horses must walk or stop prior to starting pattern. Beginning at the center of the arena facing the left wall or fence.

1. Complete four spins to the right. Hesitate.
2. Complete four spins to the left. Hesitate.
3. Beginning on the left lead, complete three circles to the left: the first two circles large and fast; the third circle small and slow. Change leads at the center of the arena.
4. Complete three circles to the right: the first two circles large and fast; the third circle small and slow. Change leads at the center of the arena.
5. Begin a large fast circle to the left but do not close this circle. Run up the right side of the arena past the center marker and do a right rollback at least twenty feet (six meters) from the wall or fence—no hesitation.
6. Continue back around previous circle but do not close this circle. Run up the left side of the arena past the center marker and do a left rollback at least twenty feet (six meters) from the wall or fence—no hesitation.
7. Continue back around previous circle but do not close this circle. Run up the right side of the arena past the center marker and do a sliding stop at least twenty feet (six meters) from the wall or fence. Back up at least ten feet (three meters). Hesitate to demonstrate the completion of the pattern.

Pattern 7

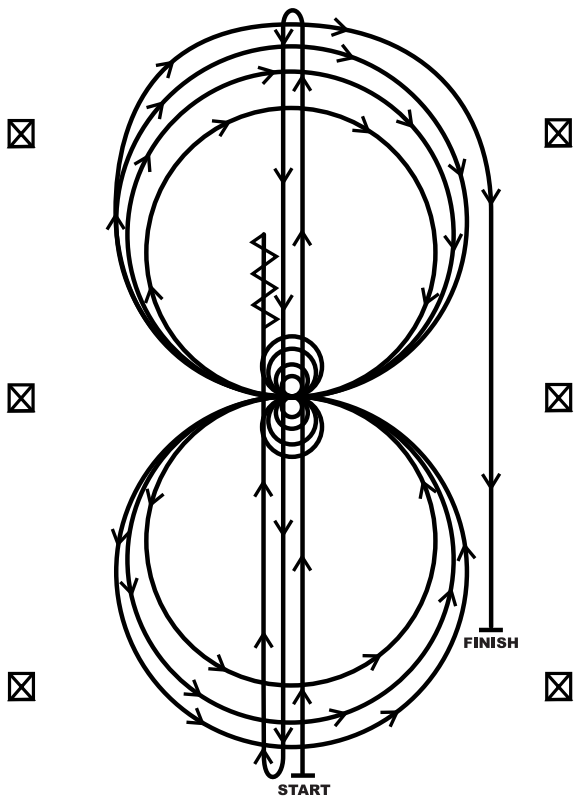

Pattern 7

- 1.** Run at speed to the far end of the arena past the end marker and do a left rollback—no hesitation.
- 2.** Run to the opposite end of the arena past the end marker and do a right rollback—no hesitation.
- 3.** Run past the center marker and do a sliding stop. Back up to the center of the arena or at least ten feet (three meters). Hesitate.
- 4.** Complete four spins to the right. Hesitate.
- 5.** Complete four and one-quarter spins to the left so that horse is facing left wall or fence. Hesitate.
- 6.** Beginning on the right lead, complete three circles to the right: the first two circles large fast; the third circle small and slow. Change leads at the center of the arena.
- 7.** Complete three circles to the left: the first two circles large fast; the third circle small and slow. Change leads at the center of the arena.
- 8.** Begin a large fast circle to the right but do not close this circle. Run straight down the right side of the arena past the center marker and do a sliding stop at least twenty feet (six meters) from the wall or fence. Hesitate to demonstrate completion of the pattern.

Pattern 8

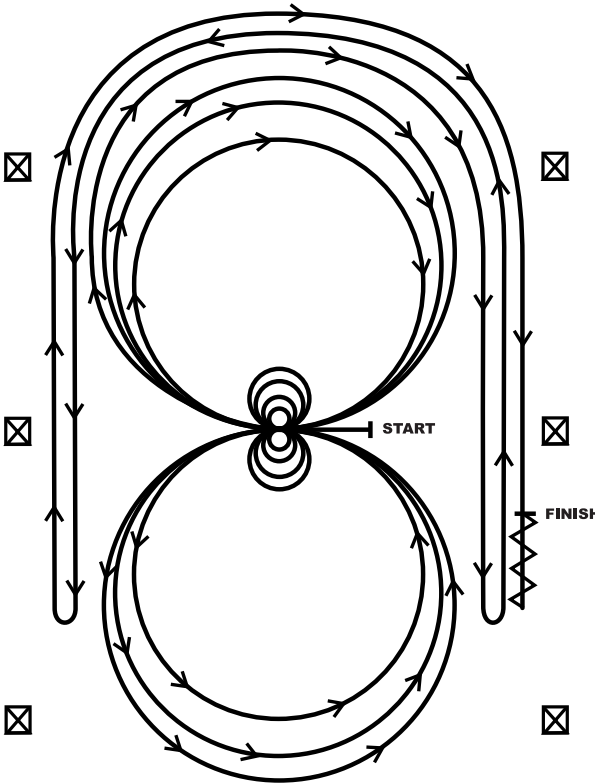

Pattern 8

Horses may walk or trot to the center of arena. Horses must walk or stop prior to starting pattern. Beginning at the center of arena facing the left wall or fence.

- 1.** Complete four spins to the left. Hesitate.
- 2.** Complete four spins to the right. Hesitate.
- 3.** Beginning on the right lead, complete three circles to the right: the first circle large and fast; the second circle small and slow; the third circle large and fast. Change leads at the center of the arena.
- 4.** Complete three circles to the left: the first circle large and fast; the second circle small and slow; the third circle large and fast. Change leads at the center of the arena.
- 5.** Begin a large fast circle to the right but do not close this circle. Run straight down the right side of the arena past the center marker and do a left rollback at least twenty feet (six meters) from the wall or fence—no hesitation.
- 6.** Continue back around the previous circle but do not close this circle. Run down the left side of the arena past the center marker and do a right rollback at least twenty feet (six meters) from the wall or fence—no hesitation.
- 7.** Continue back around the previous circle but do not close this circle. Run down the right side of the arena past the center marker and do a sliding stop at least twenty feet (six meters) from the wall or fence. Back up at least ten feet (three meters). Hesitate to demonstrate completion of the pattern.

Pattern 9

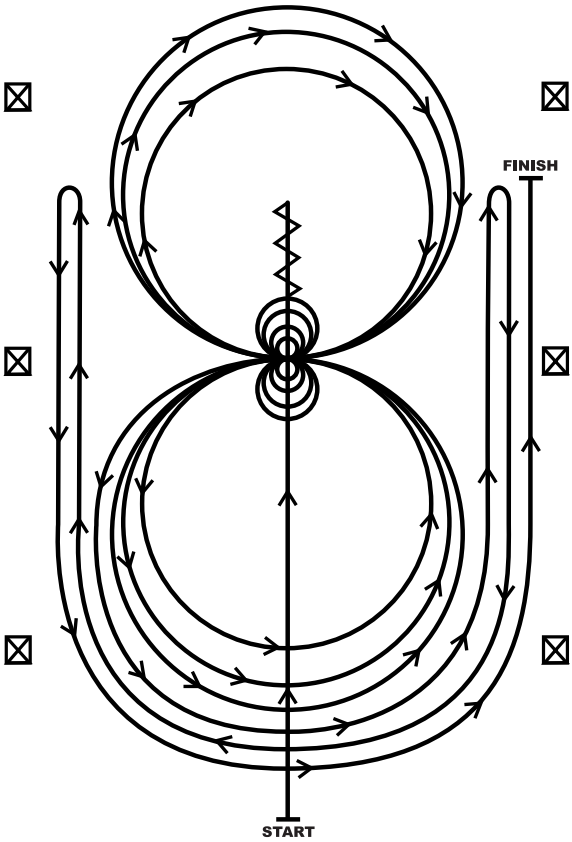

Pattern 9

1. Run past the center marker and do a sliding stop. Back up to the center of the arena or at least ten feet (three meters). Hesitate.
2. Complete four spins to the right. Hesitate.
3. Complete four and one-quarter spins to the left so that horse is facing the left wall or fence. Hesitate.
4. Beginning on the left lead, complete three circles to the left: the first circle small and slow; the next two circles large and fast. Change leads at the center of the arena.
5. Complete three circles to the right: the first circle small and slow; the next two circles large and fast. Change leads at the center of the arena.
6. Begin a large fast circle to the left but do not close this circle. Run up the right side of the arena past the center marker and do a right rollback at least twenty feet (six meters) from the wall or fence—no hesitation.
7. Continue back around the previous circle but do not close this circle. Run up the left side of the arena past the center marker and do a left rollback at least twenty feet (six meters) from the wall or fence—no hesitation.
8. Continue back around previous circle but do not close this circle. Run up right side of the arena past the center marker and do a sliding stop at least twenty feet (six meters) from the wall or fence. Hesitate to demonstrate completion of the pattern.

Pattern 10

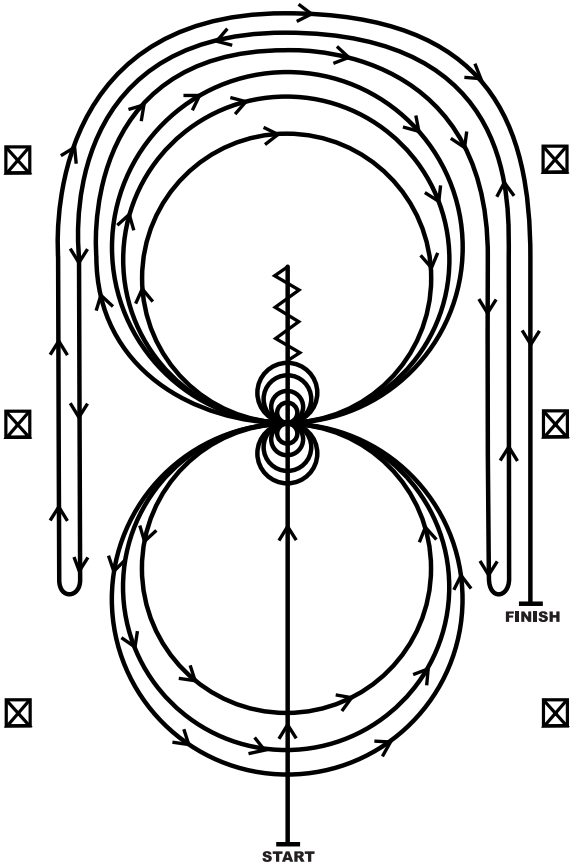

Pattern 10

1. Run past the center marker and do a sliding stop. Back up to the center of the arena or at least ten feet (three meters). Hesitate.
2. Complete four spins to the right. Hesitate.
3. Complete four and one-quarter spins to the left so that the horse is facing the left wall or fence. Hesitate.
4. Beginning on the right lead, complete three circles to the right: the first two circles large and fast, the third circle small and slow. Change leads at the center of the arena.
5. Complete three circles to the left: the first circle small and slow, the next two circles large and fast. Change leads at the center of the arena.
6. Begin a large fast circle to the right but do not close this circle. Run down the right side of the arena past the center marker and do a left rollback at least twenty feet (six meters) from the wall or fence—no hesitation.
7. Continue back around the previous circle but do not close this circle. Run down the left side of the arena past the center and do a right rollback at least twenty feet (six meters) from the wall or fence—no hesitation.
8. Continue back around previous circle but do not close this circle. Run down the right side of the arena past the center marker and do a sliding stop at least twenty feet (six meters) from the wall or fence. Hesitate to demonstrate completion of the pattern.

Pattern 11

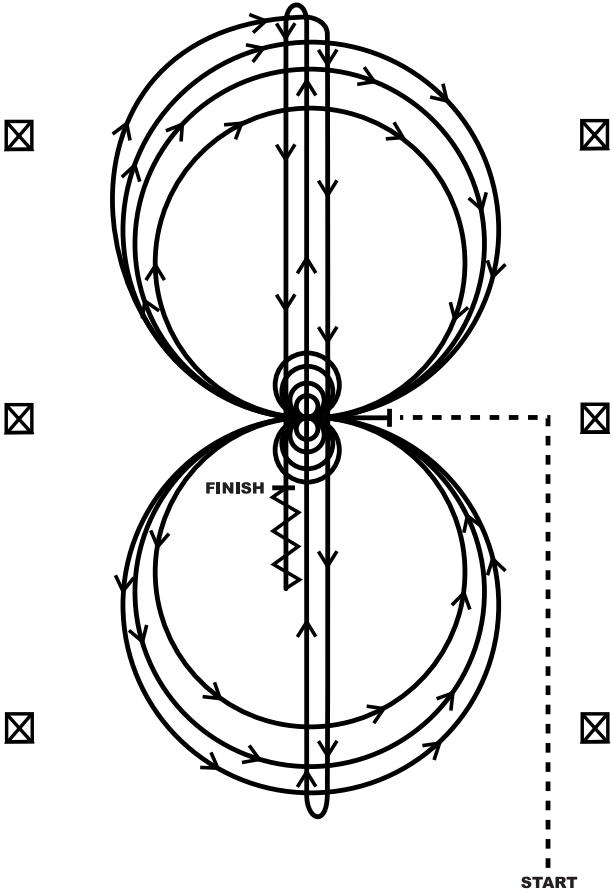

Pattern 11

Horses must trot to the center of the arena. Horses must walk or stop prior to starting the pattern. Beginning at the center of the arena facing the left wall or fence.

- 1.** Complete four spins to the left. Hesitate.
- 2.** Complete four spins to the right. Hesitate
- 3.** Beginning on the right lead complete three circles to the right; the first circle small and slow; the next two circles large and fast. Change leads at the center of the arena.
- 4.** Complete three circles to the left; the first circle small and slow; the next two circles large and fast. Change leads at the center of the arena.
- 5.** Begin a large circle to the right, but do not close this circle. Run down the center of the arena past the end marker and do a right rollback—no hesitation.
- 6.** Run up the middle to the opposite end of the arena past the end marker and do a left rollback—no hesitation.
- 7.** Run past the center marker and do a sliding stop. Back up to the center of the arena or at least ten feet (three meters). Hesitate to demonstrate completion of the pattern.

Pattern 12 Short Stirrup Pattern

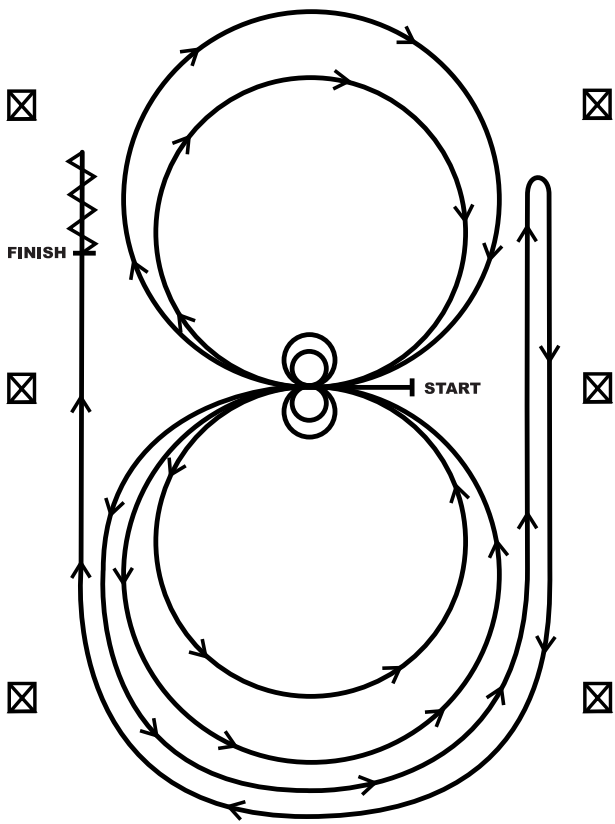

Pattern 12

To be used for the Youth 10 & Under Short Stirrup class only.

Horses may walk or trot to the center of the arena. Horses must walk or stop prior to starting the pattern. Beginning at the center of the arena facing the left wall or fence.

1. Beginning on the left lead, complete two circles to the left. Stop at the center of the arena. Hesitate.
2. Complete two spins to the left. Hesitate.
3. Beginning on the right lead complete two circles to the right. Stop at the center of the arena. Hesitate.
4. Complete two spins to the right. Hesitate.
5. Beginning on the left lead, go around the end of the arena, run down the right side of the arena past center marker, stop and roll back right.
6. Continue around the end of the arena to run down the left side of the arena past the center marker. Stop. Back up.

See the Judges' Guide for a summary of other allowances made in the *Handbook*.

Pattern 13

Short Stirrup Pattern

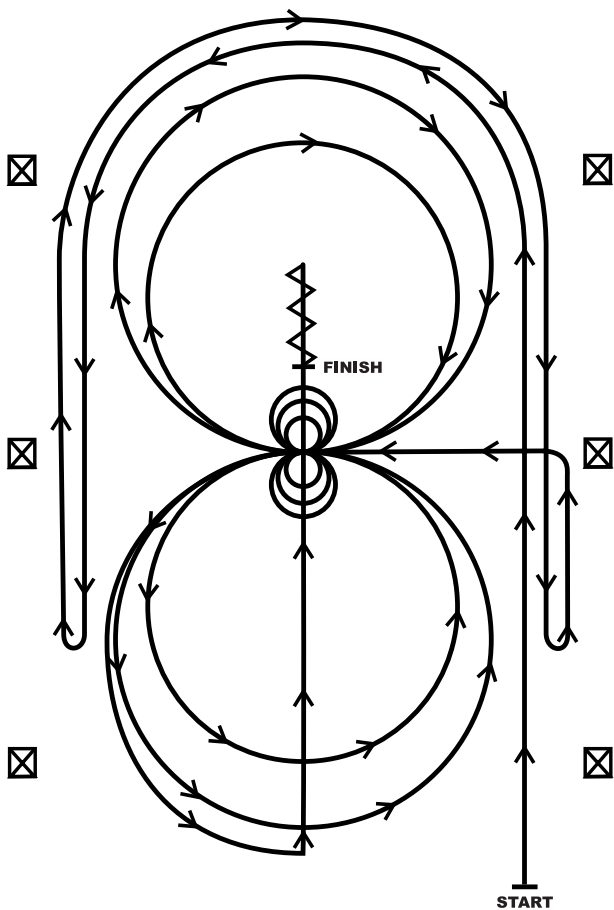

Pattern 13

To be used for the Youth 10 & Under Short Stirrup class only.

1. Beginning, lope straight up the right side of the arena, circle the top of the arena run straight down the opposite or left side of the arena past the center mark and do a right rollback—no hesitation.
2. Continue straight up the left side of the arena circle back around the top of the arena run straight down the right side of the arena past the center marker and do a left rollback—no hesitation.
3. Continue up the right side of the arena to the center marker, at the center marker the horse should be on the left lead and complete two circles to the left, one large fast and one small slow. Stop at center
4. Complete three spins to the left. Hesitate.
5. Complete two circles to the right, one large fast and one small slow. Stop at center.
6. Complete three spins to the right. Hesitate.
7. Begin a large fast circle to the left, do not close the circle. Continue up the center of the arena past the center marker and do a sliding stop.
8. Back up at least ten feet. Hesitate to demonstrate completion of the pattern.

See the Judges' Guide for a summary of other allowances made in the *Handbook*.

Notes

NRHA JUDGES' GUIDE

GENERAL JUDGING AND SCORING GUIDELINES

Section 1. As stated in the National Reining Horse Association Bylaws, one of the objectives of the Association is "The development of suitable and proper standards of performance and judging." The *NRHA Handbook* specifies the rules under which all NRHA Reinings will be conducted and the rules by which reining horses will be judged. The following is intended as a guideline for the application of the rules for the judging as specified in the *NRHA Handbook*:

Section 2. The *NRHA Handbook* includes specific patterns which the reining horse must execute exactly, and it also contains certain specific rules involving the penalties which are applied if a horse fails to perform these specific patterns as required. The *NRHA Handbook* also, under Rules for Judging, Section A, describes in detail the standard by which a reining should be judged. This description remains unchanged throughout the evolution of the NRHA, and because of its importance in evaluating a reining horse, is reprinted in full herein. This paragraph clearly defines the quality required of a reining horse and is our strongest tool in providing clear and consistent evaluations of quality.

Section 3. "To rein a horse is not only to guide him, but also to control his every movement. The best reined horse should be willingly guided or controlled with little or no apparent resistance and dictated to completely. Any movement on his own must be considered a lack of control. All deviations from the exact written pattern must be considered a lack of or temporary loss of control; and therefore, a fault that must be marked down according to severity of deviation. After deducting all faults set here within, against execution of the pattern and the horse's overall performance, credit should be given for smoothness, finesse, attitude, quickness and authority of performing various maneuvers, while using controlled speed which raises the difficulty level and makes him more exciting and pleasing to watch to an audience."

Section 4. The scoring of reining horses is on a positive numeric scale with 70 denoting an average performance. NRHA patterns are comprised of several distinct maneuver groups which judges are asked to evaluate on an individual basis dependent on execution as dictated by the pattern description and the rules for judging, and against the quality standard described in Section A. The individual maneuvers are scored in $\frac{1}{2}$ point increments from a low of $-1\frac{1}{2}$ (extremely poor quality) to a high of $+1\frac{1}{2}$ (excellent quality) with a score of 0 denoting a maneuver that is correct with no degree of difficulty. The total of the scores applied to the maneuver groups is combined with the starting score of 70 and from this gross maneuver score, any penalties are deducted to cal-

culate the horse's final score, which is announced after each horse works.

Section 5. An important non penalty consideration for judges is a horse stumbling. If the stumble is severe enough to significantly detract from the quality of the maneuver, NRHA requires a judge to reduce the score $\frac{1}{2}$ point for that maneuver (i.e., very good circles with a plus one evaluation would then become plus $\frac{1}{2}$).

Section 6. Failure to display the correct exhibitor number will result in a \$25 fine. When the judge determines that either the incorrect number is displayed or that no number is displayed, the scribe should note this fact on the score sheet and report the infraction to the Show Representative or Show Steward. The Show Representative/Steward should then note the incident on their Show Report.

Section 7. NRHA believes in the importance of providing challenged riders with the opportunity to compete on a fair basis. The NRHA Judges Committee will evaluate individual requests from challenged riders regarding the use of aids while they exhibit. If an individual is granted special privileges, then he/she will be presented said privileges in writing and must provide a copy of the letter to the show management each time he/she exhibits. The show management is required to present this copy to the judge(s) as well as the individual's draw number and exhibitor number prior to each class in which he/she will be competing. While allowing for the use of the approved aid(s), judge(s) are required to apply penalties and evaluate maneuvers in accordance to NRHA guidelines. If there is any failure in communicating the approval of a rider's aid(s), then the judge should contact the NRHA office immediately.

PENALTY APPLICATION

Section 1. The above describes the manner in which a judge evaluates and scores a horse's execution of the NRHA maneuvers. In addition to this evaluation process, the *NRHA Handbook* specifies certain penalties which are applied should a horse fail to execute a precise maneuver or deviate from performing the exact, written pattern. These penalties, as mentioned above, are subtracted from the score which the judge has awarded the horse, and thus have a negative impact on the final score the horse receives. No NRHA judge is empowered to change or alter the specific penalties listed in the *NRHA Handbook*. The judge's function is to determine whether a penalty has occurred and to apply the appropriate penalty in each instance. The NRHA has specified that in every instance, the horse should receive the benefit of any doubt when these penalties are applied. Therefore, if a judge is uncertain as to whether a horse has incurred a specific penalty, the penalty should not be applied. The application of all penalties is not a

qualitative determination (i.e., there is no good or bad way to incur an over spin). Maneuver evaluations and penalty applications are always to be determined independently.

Section 2. The penalties specified in the *NRHA Handbook* are reviewed annually by the NRHA Board of Directors and Judges Committee. It is the intention of the NRHA that these penalties be applied evenly and without amendment by every judge. It is equally imperative that every judge gives benefit of any doubt he/she may have to the exhibitor when assessing whether in fact a penalty has occurred.

PRE/POST CHECK

Section 1. NRHA requires riders to dismount and drop their bridles for inspection before or after showing, either in the arena for a judge or in close proximity to the arena for the designated judge in multiple judge situations. Failure to comply with this rule shall result in a no score. Judges are required to call all occurrences of illegal equipment, unsportsmanlike conduct, and evidences of abuse, without fail. As with any penalty application within NRHA, judges are advised that should there be any doubt as to whether or not there has been a violation, benefit of this doubt shall always go to the contestant. Also, judges are advised not to drop or assist in dropping bridles for contestants, this is to be done by the contestant or his/her designated assistant.

Section 2. Should the judge responsible for examining horses and equipment determine that a rule violation has occurred, that results in a no score the exhibitor or his/her representative, trainer or guardian may at that time accept the no score and allow the equipment judge to cause the appropriate changes to all score cards or request the other judges confer on the appropriate call. If contested, the equipment judge should so indicate to the other judges immediately, and detain the horse and equipment until it is possible for the other judges to complete an inspection of said violation. In a multiple judge situation where the equipment judge is located outside the arena, any infraction detected by the equipment judge should be examined by all other judges as soon as is practical if contested by the exhibitor.

Section 3.

(a) Show committees have the option of using a pre-check or a post-check. When a pre-check is used, there shall be no routine post-check. A pre-check system should not be used in a single judged event. When a pre-check is used, it is strongly recommended that there be a designated area in close proximity to the pre-check judge for the checked horses to remain until they enter the arena.

(b) When a pre-check is used, the presence of fresh blood or any other evidence that any act of abuse has occurred prior to the check will result in a no score (see Rules for

Judging, B. Scoring [4]). If illegal equipment is presented at the pre-check, the exhibitor will not receive a no-score, if he/she is able to correct the problem without delaying the class. If a checked horse leaves the field of vision of the pre-check judge prior to showing, the pre-check judge is to recheck the horse before allowing it to enter the arena.

(c) In this system the first two horses should be pre-checked 8-10 minutes before the class begins, with all remaining horses checked when they are in-the-hole. It is suggested that the pre-check judge, as soon as the first three horses have been checked, develop the routine of checking each horse as it becomes the in-the-hole horse. This requires the judge to keep track of only two horses at any one time, the already examined on-deck and in-the-hole horses. In addition, this allows each exhibitor time to regain composure and focus following the check, and it gives an exhibitor time to correct an equipment problem should one occur. Before entering the arena each horse will have a final walk around inspection.

(d) When a pre-check system is used, all officiating judges, including the pre-check judge, are compelled to call any acts of abuse to a horse while in the arena. If the situation arises where a chair judge calls a no score, the judge making the call should request that the exhibitor present his/her horse to the pre-check judge for inspection. If a no score is called, the exhibitor can accept or contest the call. If contested, the other judge(s) shall be called as soon as is practical to examine the horse and confer.

NO SCORES

Section 1. The *NRHA Handbook* specifies that horses are to be disqualified and receive a no score if the infractions of “abuse of a horse or misconduct by the rider” are incurred. Misconduct may include failure to present the horse and equipment for inspection before or after completing the pattern and/or any disrespectful or unprofessional conduct by the exhibitor. This includes not dismounting prior to dropping the bridle.

Section 2. While the application of a penalty for abuse requires the discretion of the judge, this judge must make his/her determination based on NRHA guidelines. The NRHA has determined that the exhibition of a horse that is obviously lame or is otherwise in an unhealthy condition must be considered abuse. The exhibition of a horse that has a cut or abrasion showing clear evidence of fresh blood in the mouth, nose, chin, shoulder, barrel, flank or hip area (those areas reasonable to believe the injury may have been caused by the rider or equipment) must be considered abuse regardless of how the injury was caused.

Section 3. Included in the infraction of abuse is the use of

illegal equipment. The *NRHA Handbook* specifies the following as illegal equipment:

- (a) bits and snaffle bits with mechanical devices;
- (b) leveraged bits and snaffle bits having mouthpieces constructed from anything other than smooth rounded material, (Note: Twisted wire mouthpieces are illegal);
- (c) Leveraged bits with mouthpiece bar spaces less than $\frac{5}{16}$ " or greater than $\frac{3}{4}$ " diameter;
- (d) nothing may protrude more than $\frac{1}{8}$ " below the mouthpiece (bar);
- (e) *bits with ports exceeding $3\frac{1}{2}$ " in height;
- (f) *snaffle bits with rings smaller than 2" or larger than 4" in diameter;
- (g) *snaffle bits with mouthpieces smaller than $\frac{5}{16}$ ", measured 1" from the cheek. (Note: It should be noted that a conventional snaffle can only be broken in one place. A conventional snaffle may have loose rings. An optional curb strap is acceptable provided it is loose, however curb chains are not acceptable. No minimum or maximum width is required, decorative knots and round material are acceptable.)
- (h) rope or leather bosals with wire, iron or mechanical devices;
- (i) *bosal larger than $\frac{3}{4}$ " diameter on the cheek;
- (j) twisted curb chains or curb chains with barbs and/or wire;
- (k) *wire on bits (Note: Spade bits may have wire wrap on spacer bar only);
- (l) use of tack collars, tie downs, nose bands, electric shocks, whips or bats;
- (m) use of any attachment which alters the movement of or circulation of the tail.

(*See Figures #1 & #2.)

Section 4. Abuse as defined in the *NRHA Handbook* is "That which a reasonable person informed and experienced in generally accepted equine training and exhibition procedures, would determine to be cruel, abusive and inhumane." A judge is thus compelled to disqualify any horse that he/she feels is being exhibited in a manner which is cruel, abusive and inhumane. This may include the exhibition of an animal which is clearly not in a fit or sound condition, the use of abusive equipment, and/or the use of abusive showing techniques by the rider. A judge(s) may excuse a horse at anytime while in the arena for unsafe conditions or improper exhibition caused by the horse and/or the rider. While each judge is required to disqualify any horse exhibited in the manners described above, it should be noted that in every case the exhibitor should be given the benefit of any doubt, should any doubt exist.

Section 5. Judges are required to report no score situations to the NRHA Representative or Steward with instructions to include the details of said no score in the official show representative's report. Further, a judge (or judges) must present in

writing any grievance that he/she may have against contestants or shows to an official officer, director, or duly elected or appointed contestant's representative of the NRHA at the time of the grievance. It should be noted that a judge is not required to post a \$100.00 grievance fee.

PENALTY SCORE ZERO

Section 1. The *NRHA Handbook* specifies certain situations in which a horse will receive a score of 0 regardless of its execution of the pattern. These situations shall be reported by a judge to a scribe as "penalty score zero." This is extremely important to avoid confusion in the scribe's recording. The *NRHA Handbook* prohibits the use of more than the index finger between the reins, the changing of hands on the reins, or use of two hands on the reins; however, it specifically outlines situations in which the rider's free hand may be used to untangle excess rein (any place the horse is allowed to be completely stopped during the pattern). The *NRHA Handbook* also permits the rider to use his/her free hand to hold a romal in the normal fashion; the definition of which is contained hereunder: Exceptions occur in the Snaffle Bit & Hackamore, Freestyle, Youth 10 & Under, NRHA Green and Ride classes. See rules for each class.

Section 2. When using a romal, the rider's hand shall be around the reins with the wrist kept straight and relaxed, the thumb on top and the hand closed around the reins; no fingers between the reins are allowed. The free hand may be used to hold the romal provided it is held in a relaxed position and there are at least 16 inches of romal from the free hand to the reining hand. Use of the free hand while holding the romal to alter the tension or length of the reins from the bridle to the reining hand is considered to be the use of two hands and a score of 0 will be applied. Consistent with NRHA rules regarding split reins, a rider using a romal may untangle excess rein (romal) any place a horse is allowed to be completely stopped during the pattern.

Section 3. A penalty score 0 shall also be incurred if a horse fails to complete the pattern as written, performs the maneuvers in other than the specified order, and/or includes maneuvers not specified. Included as maneuvers in other than the specified order, is the situation wherein a horse runs circles out of order (i.e., when a small slow and large fast circles are required, and the horse runs a large fast and small slow and large fast set of circles) and on run in patterns, once beginning a canter a complete stop prior to reaching the first marker. In the instance where a horse backs up where a backup is not specified, the penalty score of 0 will be incurred should the horse back more than 2 full strides. It is important to note one stride is defined as the complete movement or steps of all four legs, one time. In this particular situation it is very helpful

for a judge to watch and count the steps of the front feet. Up to and including four steps of the front feet in the non required backup receives no penalty. The horse must complete 5 or more consecutive steps backward without stepping forward to be considered an inclusion of a maneuver. Whenever a horse deviates from the exact written pattern by turning more than $\frac{1}{4}$ of the geographical circumference of the arena (i.e., an over spin, a turn during a backup, etc.), the penalty score of 0 will be applied. When a horse stops (completely losing forward motion) where a stop is not required, an inclusion of maneuver has occurred and a penalty score of 0 will be applied. NRHA rules provide for an exception to this rule; a complete stop in the first $\frac{1}{4}$ circumference of a circle after a canter departure is not to be considered an inclusion of maneuver. This allows for a rider to correct a missed lead. It is important to be sure that all other penalties incurred during this situation are applied, including jogging, missed leads, and always a break of gait in lieu of the inclusion of maneuver. (See Figure #3B.)

Section 4. The *NRHA Handbook* further specifies that the refusal of a command (balk) will incur a penalty score of 0. In this instance the judge must determine that the horse blatantly and continuously refused a rider's command. In the case of a spin or a rollback, the judge must differentiate between freeze up (as discussed below) and refusal of command. The *NRHA Handbook* further states that a penalty score of 0 will be applied if a horse jogs in excess of $\frac{1}{2}$ of the circumference of a circle, or $\frac{1}{2}$ the length of the arena. (See Figure #5.) The *NRHA Handbook* also requires judges to apply a penalty score of 0 in the event that a horse or rider falls to the ground or the rider is dislodged. A horse is deemed to have fallen when its shoulder and/or hip and/or underline touches the ground. The *NRHA Handbook* also specifies that each entry must run in order drawn. Note: In multi-go events, finals qualifying horses that get a 0 or scratch will still be eligible for payouts, with a 0 placing higher than a scratch. In the event not enough horses qualify for total purse distribution, the undistributed portion of the purse will be retained by show management.

5 POINT PENALTIES

Section 1. There are four situations that require a judge to apply a five (5) point penalty. These situations are: spurring in front of the cinch, use of either hand to instill fear or praise, holding the saddle with either hand (except in the Youth 10 & Under Short Stirrup class) or blatant disobedience. The application of the spurring rule requires the judge to ensure that contact with the horse was made. The holding the saddle rule does not include incidental, brief contact (i.e., brushing the saddle with the free hand). A rider must be allowed to

straighten the latigo any place a horse may be completely stopped during the pattern. The same is true of untangling the horse's mane from the reins. Judges must allow riders to straighten reins at an appropriate place without incurring a holding the saddle or instilling praise penalty. Blatant disobedience includes kicking, biting, bucking, rearing and striking. It should be noted that judge(s) may confer and/or review the video on five (5) point penalties in accordance with NRHA rules. Therefore, it is helpful for judges in multiple judged events to require scribes to acknowledge the existence of a five (5) point penalty when reporting the score. If a lack of concurrence exists, then show management would be alerted and scores would be held pending video review or conference.

2 POINT PENALTIES

Section 1. A judge is required to apply a two (2) point penalty should a horse break gait during the execution of a pattern. The requirement here is to determine gait has been broken, not what gait or if actually a gait was reached by transition. An important consideration is a horse which, while executing a required downward speed transition, has its rear feet briefly slip on the ground without loss of the overall cadence and stride of the lope should not receive a 2 point break of gait penalty. If gait is clearly broken, it should receive the appropriate 2 point penalty. Further, should the horse stop during the downward speed transition (completely lose forward motion) an inclusion of maneuver will have occurred resulting in a penalty score of 0.

Section 2. If a horse freezes up in a spin or rollback, a 2 point penalty will be applied. The NRHA defines a freeze up as a brief but obvious refusal to start a spin or rollback or any complete stoppage of a horse's lateral shoulder movement which delays the execution of a spin or rollback. (See Figure #3A.) A judge thus must determine whether there was a momentary complete stoppage of lateral shoulder movement in a spin or rollback. It is not necessary to determine if the freeze up was caused by the horse or rider (i.e. a rider who spins 3 times, stops his/her horse and realizes the error and immediately completes the 4th spin, shall receive a freeze up penalty).

Section 3. It is required in patterns that begin in the center of the arena with a canter departure, the departure be executed from a walk or stopped position; failure to do so shall result in a judge applying a 2 point penalty. It should be noted that patterns beginning with spins at the center of the arena, failure to complete spins in the prescribed area would result in a reduction of the maneuver evaluation. On all run-in patterns, a judge is required to apply a 2 point penalty for failing to be in a canter prior to reaching the first marker or for a break of gait prior to the first marker. (See Figure #5.)

Section 4. NRHA patterns require a horse to run past a

marker placed in the arena prior to stopping. If the horse does not completely pass the specified marker before assuming a stop position, a penalty of 2 points is to be applied. It is important to note that this penalty is to be applied if the horse assumes a stop position (rear legs up underneath, setting up) whether or not this stop is completed. Further, the judge, by applying this penalty, is only reflecting the fact it happened, and should not be concerned with whether it was caused by the horse or by the rider. Judges should note that it is their responsibility to insure that these markers are placed correctly, and in such a fashion that a horse could reasonably be expected to go past them before executing a stop or rollback maneuver. The NRHA has specified that the end markers be no less than 50' from the end wall or fence of the arena.

LEAD PENALTIES

Section 1. Each time a horse is out of lead, a judge is required to penalize it by 1 point. The penalty for being out of a lead is cumulative, and the judge will add 1 penalty point for each $\frac{1}{4}$ of the circumference of a circle or any part thereof that a horse is out of lead. (See Figure #4.) A judge is further required to penalize a horse $\frac{1}{2}$ of a point for a change of lead delayed by one stride where a change of lead is required by the pattern. It should be noted that a gait is specified, but no lead is specified in the instance of run downs either on the side of the arena or through the middle of the arena, and no penalty is incurred for a horse changing leads in these areas. (See Figures #6 & #7.)

Section 2. In patterns where a horse is required to make a run around the end of the arena, the horse must be on a specific lead while rounding the end of the arena. The horse is required to be on the specified lead as soon as it completes the 1st straight portion of the run-around and begins to turn the corner of the arena. Failure to be in the correct lead beyond this point will result in the following penalties being assigned:

- (a) From the turn to the halfway position at the end wall -1 point.
- (b) Beyond the halfway point up to the beginning of the run down -2 points.
- (c) It should be noted NRHA has determined there to be no correct lead on a straight line. Therefore, changing leads in a straight line is not to be penalized, though it may or may not demonstrate resistance to being dictated to completely which must be dealt with in maneuver evaluation. (See Figures #6 & #7.)

Section 3. In the instance where a pattern requires a $\frac{1}{2}$ circle prior to beginning a run down to the other end of the arena (i.e., patterns #2 & 4), failure to be on a specified lead should be penalized as follows:

- (a) 1 point: beyond one stride up to $\frac{1}{4}$ circumference of circle

- (b) 2 points: beyond $\frac{1}{4}$ circumference of circle up to the entire half circle. (See Figure #6.)

JOG PENALTIES

Section 1. Inasmuch as a horse is required to be in a lope or a canter throughout the reining pattern, a penalty must be applied for starting a circle or exiting a rollback at a jog. Jogging up to two strides incurs a $\frac{1}{2}$ point penalty. Jogging beyond two strides will incur a 2 point penalty. (See Figure #5.) In determining whether a $\frac{1}{2}$ or 2 point penalty has been incurred it is useful for a judge to consider the distance traveled and to count the steps of the rear legs. Four steps and under would represent two or less strides and require a $\frac{1}{2}$ point penalty; five steps and more, therefore, require a 2 point penalty.

SIMPLE LEAD CHANGE PENALTIES

Section 1. In classes which allow simple lead changes, the ideal change is to jog for one stride to change leads. Any deviation from the ideal change that takes place in the lead change area as described by the *Handbook* would not incur a penalty but deserves less credit. In order of decreasing difficulty would be jogging more than one stride, walking rather than jogging, stopping during the change and finally more than one attempt to execute the change. Penalties would apply if the lead change was early or late just as they would for a flying lead change.

Section 2. Judges should allow one-quarter circle coming into the change and one-quarter circle going past the change as an allowable simple change area (safe zone), with only the out of lead penalties applying. For example, a horse that comes across and takes 3 strides past “center” to complete the simple change, but before the end of the first quarter, would not get a break of gait penalty but would incur a one point out of lead penalty. The same logic would apply for changes before reaching center. All penalty applications would apply out of that “safe zone.”

SPIN PENALTIES

Section 1. When performing the spin maneuver, horses are required to stop and start in a precise direction within the arena. Failure to stop a spin with some portion of the horse’s shoulder and hip aligned with the proper position will result in a penalty. A horse can only be assessed one over or under spin penalty per maneuver. The penalties assigned to over and under spinning are as follows:

- (a) Over or under spinning beyond a shoulder width and up to $\frac{1}{8}$ of the circumference of the spin- $\frac{1}{2}$ point penalty.
- (b) Over or under spinning up to $\frac{1}{4}$ of the circumference of the spin 1 point penalty.
- (c) If a horse over spins by more than $\frac{1}{4}$ of the circumference

of a spin, an additional maneuver is deemed to have been included and a score of 0 will be applied. It should be noted that the shoulder width tolerance applied when determining the first $\frac{1}{8}$ over or under spin should not be applied when determining the severity of the deviation (i.e. the determination of a $\frac{1}{2}$ or a 1 point penalty or the determination of a 1 point penalty or a 0 score).

(d) In the instance where a horse under spins by more than $\frac{1}{4}$ of the circumference of a spin and is properly realigned before starting the next maneuver, it shall be considered a freeze up in the spin and a 2 point penalty will be assigned. (See Figure #3A.)

WALL PENALTY

Section 1. In NRHA patterns that require a horse to run around the end of the arena, it is specified the horse must remain a minimum of 20 feet from the side of the arena when approaching a stop and/or rollback. Failure to do so will result in a $\frac{1}{2}$ point penalty.

REVIEWS

Section 1. If the judge is unsure as to whether a major penalty has occurred (i.e., no score, a 0 score, or a 5 point penalty) the judge will submit his/her score and ask that the score be held pending a conference or a review of the video at the next drag. Further, it must be remembered that the *NRHA Handbook* does not allow judges to confer as to any penalty or maneuver score prior to submitting a score. Video reviews may only be utilized in the instance where the judge believes that all entrants have been videotaped by an official videographer. A judge shall not be required to change his/her score following a conference or video review, each judge's decision is an individual call.

Section 2. Judges must continue to score no scores and 0 scores in a multiple judged or videotaped event. This allows for video review and/or conference with the other judge(s) without the potential bias that could exist if a judge should need to reverse his/her original decision or rely on memory to score the run. Whether or not a class is videotaped or multiple judged, it is suggested that NRHA judges continue to mark all runs whenever possible, as a service to our members.

Section 3. An exhibitor or owner in the respective class may request a review of a major penalty (penalty score zero and 5 point penalty). The judge(s) has the right to deny or honor the request. If honored by the judge(s) he/she must believe the entire class was videotaped by an official videographer. The request must be made no later than 30 minutes after the last run of the day and before the judge(s) has left the grounds for the day. In cases where a class is run in sections over multiple days, each day's scores will be official thirty minutes after the

last run of each section. Exhibitors or owners may not have direct contact with the judge(s) during the entire process of requesting a review. The request must be submitted to the Show Steward, Show Representative, or if need, Show Management who will take the request to the judge(s)

MANEUVERS

As mentioned earlier, judges are required to score a reining horse based on its execution of the maneuver groups required in each pattern. All NRHA patterns are divided into seven or eight maneuver groups. Descriptions of ideal maneuvers required of a reining horse are as follows:

Walk-in

The walk-in brings the horse from the gate to the center of the arena to begin its pattern. The horse should appear relaxed and confident. Any action which may create the appearance of intimidation including starting and stopping, or checking is a fault which shall be marked down according to the severity in the first maneuver score.

Trot-in

Horses must jog the majority of the way to the center. Failure to jog the majority of the way to the center will result in a 0 for failure to complete the pattern as written.

Stops

Stops are the act of slowing the horse from a lope to a stop position by bringing the hind legs under the horse in a locked position sliding on the hind feet. The horse should enter the stop position by bending the back, bringing the hind legs further under the body while maintaining forward motion and ground contact and cadence with front legs. Throughout the stop, the horse should continue in a straight line while maintaining ground contact with the hind feet.

Spins

Spins are a series of 360-degree turns, executed over a stationary (inside) hind leg. Propulsion for the spin is supplied by the outside rear leg and front legs, and contact should be made with the ground and a front leg. The location of hindquarters should be fixed at the start of the spin and maintained throughout the spins. It is helpful for a judge to watch for the horse to remain in the same location, rather than watching for a stationary inside leg. This allows for easier focus on other elements of the spin (i.e., cadence, attitude, smoothness, finesse, and speed).

Rollbacks

Rollbacks are the 180 degree reversal of forward motion completed by running to a stop, rolling (turning) the shoulders back to the opposite direction over the hocks and departing

in a canter, as one continuous motion. The *NRHA Handbook* states no hesitation; however, a slight pause to regain footing or balance should not be deemed hesitation. The horse should not step ahead or backup prior to rolling back.

Circles

Circles are maneuvers at the lope, of designated size and speed, which demonstrate control, willingness to guide, and degree of difficulty in speed and speed changes. Circles must at all times be run in the geographical area of the arena specified in the pattern description and must have a common center point. There must be a clearly defined difference in the speed and size of a small, slow circle, and a large, fast circle; also, the speed and size of small, slow right circles should be similar to the small, slow left circles; and the speed and size of the large, fast right circles should be similar to the large, fast left circles.

Backups

A backup is a maneuver requiring the horse to be moved in a reverse motion in a straight line a required distance; at least 10 feet.

Hesitate

To hesitate is the act of demonstrating the horse's ability to pause in a relaxed manner, at a designated time in the pattern. All NRHA patterns require a hesitation at the end of the final maneuver to indicate to the judge(s) the completion of the pattern.

Lead Changes

Lead changes are the act of changing the leading legs of the front and rear pairs of legs, at a lope, when changing the direction traveled. The lead change must be executed at a lope with no change of gait or speed and be performed in the exact geographical position in the arena specified in the pattern description. The change of front and rear leads must take place within the same stride to avoid penalty.

Run Downs and Run-arounds

Run downs are runs through the middle of the arena, and runs along the side and ends of the arena. Run downs and run-arounds should demonstrate control and gradual increase in speed to the stop.

PATTERN DESCRIPTIONS

The NRHA has divided its patterns into sets of seven or eight maneuver groups, which are scored as described earlier. These patterns break down as follows:

PATTERN 1

Maneuver 1

Run down the middle, past the end marker, left rollback

Maneuver 2

Run down the middle, past the opposite end marker, right rollback

Maneuver 3

Run down the middle, past the center marker, stop, backup, hesitate

Maneuver 4

4 right spins, hesitate

Maneuver 5

4 1/4 left spins, hesitate

Maneuver 6

Left circles departure, large fast, small slow, large fast, lead change

Maneuver 7

Right circles large fast, small slow, large fast, lead change

Maneuver 8

Complete 3/4's of a large fast left circle, run down side past center marker, stop, hesitate

PATTERN 2

Maneuver 1

Right circles departure, small slow, two large fast, change leads

Maneuver 2

Left circles small slow, two large fast, change leads

Maneuver 3

Continue around previous circle to the right. At the top of the circle, run down the middle past end marker, right rollback

Maneuver 4

Run down middle past the opposite end marker, left rollback

Maneuver 5

Run down middle past the center marker, stop, backup, hesitate

Maneuver 6

4 right spins, hesitate

Maneuver 7

4 left spins, hesitate

PATTERN 3

Maneuver 1

Run around the end of arena, run down side past center marker, left rollback

Maneuver 2

Run around end of arena, run down side past center marker, right rollback

Maneuver 3

Right circles two large fast, one small slow, change leads

Maneuver 4

Left circles two large fast, one small slow, change leads

Maneuver 5

Run $\frac{3}{4}$'s of a large fast circle, run completely around the arena, past center marker, stop, back up, hesitate

Maneuver 6

4 right spins, hesitate

Maneuver 7

4 left spins, hesitate

PATTERN 4**Maneuver 1**

Right circles departure, two large fast, small slow, stop, hesitate

Maneuver 2

4 right spins, hesitate

Maneuver 3

Left circles departure, two large fast, small slow, stop, hesitate

Maneuver 4

4 left spins, hesitate

Maneuver 5

Depart right lead, figure eight, lead change

Maneuver 6

Continue around previous circle to the right. At the top of the circle, run down the middle past end marker, right rollback

Maneuver 7

Run down middle past opposite end marker, left rollback

Maneuver 8

Run down middle past center marker, stop, backup, hesitate

PATTERN 5**Maneuver 1**

Left circles departure, two large fast, small slow, stop, hesitate

Maneuver 2

4 left spins, hesitate

Maneuver 3

Right circles departure, two large fast, small slow, stop, hesitate

Maneuver 4

4 right spins, hesitate

Maneuver 5

Depart left lead, figure eight, change leads

Maneuver 6

Run $\frac{3}{4}$'s of a large fast left circle, run down side past center marker, right rollback

Maneuver 7

Run around end of arena, run down side past center marker, left rollback

Now Available!
NRHA INSIDE REINING'S

Training Secrets Volume VII

Featuring the NRHA stars of today and tomorrow,

★ Jordan Larson ★ Todd Crawford ★ Josh Visser

★ Mark Rafacz ★ Dave Moore



Only \$19.95

(Plus shipping & handling)

Any 2 Volumes: \$35⁹⁹ (Plus S&H)

Any 3 Volumes: \$49⁹⁹ (Plus S&H)

Any 4 Volumes: \$63⁹⁹ (Plus S&H)

Any 5 Volumes: \$76⁹⁹ (Plus S&H)

Any 6 Volumes: \$89⁹⁹ (Plus S&H)

Order All 7 Volumes & Save!

\$99⁹⁹ (Plus S&H)

To order your copy today, go to
InsideReining.com or call 405-399-3122.

NRHA
NATIONAL REINING HORSE ASSOCIATION

Maneuver 8

Run around end of arena, run down side past center marker, stop, backup, hesitate

PATTERN 6**Maneuver 1**

4 right spins, hesitate

Maneuver 2

4 left spins, hesitate

Maneuver 3

Left circles departure, two large fast, small slow, change leads

Maneuver 4

Right circles two large fast, small slow, change leads

Maneuver 5

Run $\frac{3}{4}$'s of a large fast left circle, run down side past center marker, right rollback

Maneuver 6

Run around end of arena, run down side past center marker, left rollback

Maneuver 7

Run around end of arena, run down side past center marker, stop, backup, hesitate

PATTERN 7**Maneuver 1**

Run down middle past end marker, left rollback

Maneuver 2

Run down middle past opposite end marker, right rollback

Maneuver 3

Run down middle past center marker, stop, backup, hesitate

Maneuver 4

4 right spins, hesitate

Maneuver 5

$4\frac{1}{4}$ left spins, hesitate

Maneuver 6

Right circles departure, two large fast, small slow, change leads

Maneuver 7

Left circles two large fast, small slow, change leads

Maneuver 8

Run $\frac{3}{4}$'s of a large fast right circle, run down side past center marker, stop, hesitate

PATTERN 8**Maneuver 1**

4 left spins, hesitate

Maneuver 2

4 right spins, hesitate

Maneuver 3

Right circles departure, large fast, small slow, large fast, change leads

Maneuver 4

Left circles large fast, small slow, large fast, change leads

Maneuver 5

Run $\frac{3}{4}$'s of a large fast right circle, run down side past center marker, left rollback

Maneuver 6

Run around end of arena, run down side past center marker, right rollback

Maneuver 7

Run around end of arena, run down side past center marker, stop, backup, hesitate

PATTERN 9**Maneuver 1**

Run down middle past center marker, stop, backup, hesitate

Maneuver 2

4 right spins, hesitate

Maneuver 3

$4\frac{1}{4}$ left spins, hesitate

Maneuver 4

Left circles departure, small slow, two large fast, change leads

Maneuver 5

Right circles small slow, two large fast, change leads

Maneuver 6

Run $\frac{3}{4}$'s of a large fast left circle, run down side past center marker, right rollback

Maneuver 7

Run around end of arena, run down side past center marker, left rollback

Maneuver 8

Run around end of arena, run down side past center marker, stop, hesitate

PATTERN 10**Maneuver 1**

Run down middle past center marker, stop, backup, hesitate

Maneuver 2

4 right spins, hesitate

Maneuver 3

$4\frac{1}{4}$ left spins, hesitate

Maneuver 4

Right circles departure, two large fast, small slow, change leads

Maneuver 5

Left circles small slow, two large fast, change leads

Maneuver 6

Run $\frac{3}{4}$'s of a large fast right circle, run down side past center marker, left rollback

Maneuver 7

Run around end of arena, run down side past center marker, right rollback

Maneuver 8

Run around end of arena, run down side past center marker, stop, hesitate

PATTERN 11**Maneuver 1**

4 left spins, hesitate

Maneuver 2

4 right spins, hesitate

Maneuver 3

Right circles—departure, small slow, two large fast, change leads

Maneuver 4

Left circles—small slow, two large fast, change leads

Maneuver 5

Continue around previous circle to the right. At the top of the circle, run down the middle past end marker, right roll-back

Maneuver 6

Run down middle past the opposite end marker, left roll-back

Maneuver 7

Run down middle past center marker, stop, backup, hesitate

PATTERN 12

(FOR USE WITH 10 & UNDER SHORT STIRRUP ONLY)

Maneuver 1

Left circles—stop, hesitate

Maneuver 2

2 left spins—hesitate

Maneuver 3

Right circles—stop, hesitate

Maneuver 4

2 right spins—hesitate

Maneuver 5

Run around end of arena, run down right side past the center marker, right rollback

Maneuver 6

Run around end of arena, run down left side past the center marker, stop, back up.

PATTERN 13

(FOR USE WITH 10 & UNDER SHORT STIRRUP ONLY)

Maneuver 1

Run around the end of the arena, run down the left side past center marker, right rollback

Maneuver 2

Run around end of arena, run down right side past center marker, left rollback

Maneuver 3

Left circles, one large fast and one small slow, stop at center

Maneuver 4
3 spins left, hesitate
Maneuver 5
Right circles, one large fast and one small slow, stop at center
Maneuver 6
3 spins left, hesitate
Maneuver 7
Begin large fast circle to left at the top of the circle, run down the center of arena past center marker, stop
Maneuver 8
Back up at least 10 feet, hesitate

The following are allowance made for the Short Stirrup class only:

1. Riders are allowed to choose the size and speed of the circles. Excessive speed will result in a maneuver deduction.
2. Riders are allowed to hold the saddle without penalty.
3. Closed reins may be used and include but are not limited romal, roping, crossed, knotted, or taped reins.
4. Riders are allowed to ride with one or two hands at any time during the class.

A. SCORING

(1) The NRHA requires that the score for each run be reflected on a maneuver by maneuver and penalty by penalty basis utilizing a scribe and an NRHA score sheet. This score sheet represents a judge's report to an exhibitor of how a score was derived, and it is critical that this report to the exhibitor be accurate.

(2) In the name of accuracy, it is important that the judge not average scores for maneuvers (i.e., a $+\frac{1}{2}$ spin and a $-\frac{1}{2}$ spin = two 0 spins, etc.). A judge must, at the completion of each maneuver, evaluate the maneuver on the scale listed below as an individual component of the entire run.

(3) In keeping with this practice, it is also critically important that a judge not average penalties into maneuver scores. Penalties are evaluated on a separate criteria than maneuver scores and should not at any time be combined with maneuver scores (i.e., a $+\frac{1}{2}$ spin with a $\frac{1}{2}$ point over spin penalty does not = a 0 maneuver score). It is also important for a judge not to allow a penalty to adversely affect the scoring of the maneuver, unless the quality was truly affected.

(4) One key element in accurately describing the scoring of the entire run to the exhibitor is the judge's scribe. It is management's responsibility to supply a scribe at every official NRHA event; however, it is the judge's responsibility to ensure that the scribe is properly trained prior to beginning the first run of the day. The judge must confirm that the scribe understands the fundamentals of recording both maneuver scores and penalty scores. It is recommended that judges verify that the addition of the maneuver scores and penalties is correct at the completion

of the run. As part of the training process for the scribe, the judge should make certain that his/her communications are clear to the scribe. To ensure this clear communication, the judge and scribe should agree upon a method of speaking, so that maneuver scores and penalty scores are not confused (i.e., a judge will say a number for a maneuver score and will say “penalty” and a number for a penalty, thus allowing the scribe to place the appropriate score in the appropriate box on the score sheet). Scribes should be advised to record all scores and penalties in fractions as opposed to decimals to prevent errors in tabulating the final scores. If for any reason a judge does not believe that a scribe is competent, he/she should ask show management to replace the scribe immediately. An example of a correctly completed score sheet is illustrated in Figure #8 of this guide. Judges must sign every completed score sheet.

B. MANEUVER SCORES

(1) As described earlier in this guide, the NRHA has divided each pattern into sets of maneuvers. It is the judge’s responsibility to evaluate these maneuver groups individually and rate each maneuver group on the following scale:

-1½	Extremely Poor
-1	Very Poor
-½	Poor
0	Correct
+½	Good
+1	Very Good
+1½	Excellent

(2) In evaluating a maneuver, a judge should consider the horse’s performance based on the following hierarchy of concerns:

a) On pattern: The judge must ensure that the maneuver being performed by horse and rider is the correct maneuver as dictated by pattern.

(b) Correctness: Having ascertained that the horse and rider are performing the maneuver required by the pattern, the judge must then ascertain whether the maneuver is being executed correctly. In this regard, the judge must evaluate the performance of the maneuver against the requirements of the maneuver descriptions listed in this guide. In each group of maneuvers, the judge must ascertain that the horse has been dictated to completely and the basic elements of the maneuver have been fulfilled regardless of the degree of difficulty. In the instance where horse and rider have failed to correctly perform the maneuver, the judge will deduct for a substandard performance. This deduction ranges from -½ to -1½ for the maneuver.

(c) Degree of difficulty: Having ascertained that the horse and rider are on pattern and have performed the maneuver group correctly, a judge must evaluate the

degree of difficulty in completing the maneuver. In the instance where the horse has correctly performed the maneuver and has exhibited some degree of difficulty, a judge will assess the degree of difficulty on a scale of +½ to +1½. Credit for degree of difficulty should be given for using smoothness, finesse, attitude, quickness, authority and controlled speed while completing a correct maneuver.

(3) It is recommended that a judge use the same scale for evaluating a maneuver, regardless of the level of competition at an NRHA event and regardless of ground and other conditions. When utilizing the above scoring methodology, it is critically important that a judge evaluate the entire maneuver group. For example, in maneuver six of pattern eight, a judge is required to evaluate all of the following:

- (a) the run around the end of the arena
- (b) the approach to the stop
- (c) the stop
- (d) the rollback
- (e) the exit from the rollback

(4) An over emphasis of any component of the maneuver group will cause an inaccurate maneuver score.

(5) It should be noted when applying the previously described hierarchy, that during the various components of a maneuver group, a horse and rider may exhibit varying degrees of correctness and difficulty. Incorrect form, a particular component of the maneuver group does not disqualify the horse and rider from correcting the form, therefore being eligible for credit depending on degree of difficulty. For example, a horse that begins a spin incorrectly for one revolution then corrects the form and achieves a high degree of difficulty in the last three rotations would receive a score for the maneuver combining a minus score for the first rotation and a plus score for the final three rotations. Judges are required to generate a maneuver score that accurately reflects the combined correctness and degree of difficulty of the various components of a maneuver group.

C. MISCONDUCT/RE-RIDES

(1) In order to ensure that each and every exhibitor has the unconditional attention of the judge, it is imperative that the judges be allowed to concentrate on the performance of an exhibitor. In this regard, a judge must ensure that show management has provided an environment which provides for said concentration. Should any exhibitor(s) or person(s) in proximity to the show arena conduct him/her self in a manner distracting to the judge, he/she should not continue evaluating horses until the distraction has been removed by show management.

(2) If the conduct of any exhibitor is disrespectful to a judge, the judge has the right to refuse judging the exhibitor for the remainder of the show, and may request show management

remove the exhibitor from the show grounds.

(3) If an unavoidable circumstance (i.e., a fault suddenly appearing in the arena, an unpredictable major distraction to the horse, etc.) disrupts a horse and rider's pattern, the judge may allow for a re-ride. In the event a judge believes that a re-ride is warranted, he/she will ask his/her scribe to inform show management immediately upon completion of the pattern. In the case where a horse was able to complete the pattern, but a re-ride was warranted, the score should be held until the rider decides whether to exercise the re-ride option. An exhibitor who has been allowed the option of a re-ride may at his/her option:

(a) not re-ride the pattern, and be awarded the score for their original ride, **OR**

(b) re-ride the pattern in an order of go dictated by show management in consultation with judge(s), and accept the score for the second run only. A horse should never be required to rerun immediately following the original run. Rather, a sufficient amount of time should be given for the horse to rest (approximately 5 minutes). This should prevent a horse from being exhibited while in a fatigued condition.

(4) Show management, the NRHA Representative and the exhibitor have no right to petition a judge for a re-ride. Any re-ride must be entirely at the judge's prerogative.

D. REPORTS/CONDUCT

(1) Any person assuming the responsibilities of an NRHA judge is acting at all times as an NRHA official. A judge's conduct on and off the show ground must be exemplary and a reflection of the standards required by the National Reining Horse Association. A judge's judging privileges may be removed by the NRHA at any time for conduct not considered to reflect favorably upon the National Reining Horse Association.

(2) In the capacity of an official of the NRHA, it is a judge's responsibility to ensure that all deviations from NRHA standards by exhibitors or show management be noted on the NRHA representative's report. This report should include any and all examples of unprofessional conduct by exhibitors, any insufficiencies or inequities by show management, unsportsmanlike conduct by any individual, and report inhumane treatment of a horse either during exhibition or on the show grounds. It is important that a judge be aware of whom the NRHA representative is and communicates with this individual before and after the show to ensure the NRHA representative's report includes any and all concerns of the judge.

(3) When a judge agrees to officiate at an NRHA event, he/she is responsible as an official of the NRHA for ensuring that all contractual obligations with show management are both explicit and fulfilled. Any miscommunication between show management and a judge will be deemed by NRHA to be a

judge's responsibility. When a judge agrees to officiate an NRHA event, it becomes his/her responsibility to ensure the obligation is fulfilled. If a judge is unable to fulfill the obligation, it is his/her responsibility to ensure that a qualified replacement judge is available under terms suitable to the management of the event. Judges are also required to notify the NRHA office of said change.

(4) In order to fully utilize training and judging methodologies, it is imperative that all NRHA judges ensure they arrive to officiate an NRHA event in a physically well condition (i.e., well rested, prepared, on time, etc.). Judge(s) shall not appear on the show grounds more than one (1) hour prior to the scheduled start of the show unless as directed by show management.

(5) The NRHA is committed to providing its membership with the best possible judging at all levels of competition. In order to ensure this, the Association has and will continue to provide comprehensive judges applicant seminars and schools at a low cost to the individual participant in key areas throughout the reining world. The NRHA Judges Committee encourages feedback from judges, and any comments that might assist the Committee to ensure that all judging is of world class caliber.

Notes

Notes

FREESTYLE

A. SCORE CARD

(1) The NRHA has revised its standard score card for reining to accommodate the special needs of the Freestyle. (See Figure #9.)

(a) “Maneuver description” Each of the 7 required maneuvers are outlined above a specific box. Box #8 is for scoring circles, transitional maneuvers and non-required maneuvers.

(b) The line containing the “Draw/Exhibitor” box is divided into a top and bottom row. The top row is used to record any appropriate penalties and the bottom to record required maneuver scores as performed. Each maneuver box may contain multiple scores if the maneuver is performed more than once during the program.

(c) “Penalties” are to be assessed during each maneuver in which they occur and each time they occur; for example, penalties associated with lead changes will appear in the #3 and #4 boxes respectively and may be multiple if occurring more than once.

(d) The scoring of maneuvers in Freestyle remains consistent with the guidelines set forth in *NRHA Handbook*. Maneuvers are scored in $\frac{1}{2}$ point increments from a low of $-1\frac{1}{2}$ (extremely poor quality) to a high of $+1\frac{1}{2}$ (excellent quality) with 0 denoting an average or correct maneuver with little or no degree of difficulty. The “Score” boxes below the “Draw/Exhibitor” box line are used to record the official score of each required maneuver. The scores in the corresponding box above will be “averaged” and dropped down as a single official score recorded in the “Score” box. In the event a score averages a fraction other than those of $\frac{1}{2}$ point increments allowed in the scoring range, one should follow the standard mathematical practices of rounding. This will allow for the scoring of the maneuver as a “required” maneuver as well as an additional score for each time the maneuver occurs during the remainder of the performance. The required and additional scores from the “Draw/Exhibitor” box line are considered notes by the judge to aid in his/her evaluation of the maneuver designated for that box. They are not considered an official score. The total scores on the score line minus any penalties incurred (added or subtracted from 70), result in the final official score of the performance.

EXAMPLES:

Box #1 (4 L spins)

Scored a $+\frac{1}{2}$ for the required maneuver

Scored a 0 and $-\frac{1}{2}$ for additional maneuvers

Therefore, average score = 0

Box #1 (4 L spins)

Scored a 0 for the required maneuver

Scored a $+\frac{1}{2}$ and a $+\frac{1}{2}$ for additional maneuvers

Therefore, average score = .33, rounded up to a $+\frac{1}{2}$

Box #1 (4 L spins)

Scored a $-\frac{1}{2}$ for the required maneuver

0 and $-\frac{1}{2}$ for additional maneuvers

Therefore, average score = -.33, rounded down to a -½
(e) Box #8 may include multiple scores for any transitional maneuvers, circles that have not been evaluated in conjunction with another maneuver, or other non-required maneuvers as they occur. Scores are averaged and recorded in the “Score” box #8 as an overall score.

(f) If a required maneuver is not performed, the maneuver box will be blank indicating failure to perform all the required maneuvers resulting in a score of 0.

(g) In the event an “artistic impression” judge is not present, a box for an overall artistic impression score is available under the Total Penalty Box. Artistic impression may be scored in ½ point increments from a low of -2 to a high of +2. This score should consider the suitability of music, choreography and presentation of the ride.

B. SCORING PENALTIES

(1) **General Scoring Guidelines.** Scoring Freestyle requires the same rigor and diligence be applied to determine the quality of a maneuver as in any other reining class. The *NRHA Handbook* specifies that Freestyle allow the exhibitor to use maneuvers creatively but the evaluation of those maneuvers remain consistent with guidelines set forth in the *NRHA Handbook* (i.e., a 0 maneuver is the same in Freestyle as any other class). The scoring range for Freestyle maneuvers shall remain from -1½ to +1½ in ½ point increments.

(2) **Artistic Impression.** NRHA judges score the artistic impression of a performance from -2 to +2 using the following criteria:

1. Choreography: This refers to the planning and arranging of movements, steps and patterns for dancing in rhythm with the music. Ask, does the pattern flow in time and cadence with the music? If not it does not meet this parameter, it should get a (-) for this area; if it does, the ride should get merit (+). Some pieces may have partial choreography but places where it is absent, and thus a (0) for this component.

2. Originality: Ask, does this presentation bring “anything new” to the development of Freestyle Reining? New moves, maneuvers, ways of presenting the required maneuvers, increased difficulty, etc? Score accordingly (+, 0, -).

3. Musicality: This refers to how music is used in the presentation to develop the theme or “mood” of the piece/performance. Did what was presented appeal to the senses and the emotional aspects of the ride, be it serious/humorous/romantic, etc? Score accordingly (+, 0, -)

4. Presentation & Balance: This simply said, refers to how well the ride plays to all areas of the audience; does it cover the entire arena and entertain all areas of the audience equally? Score according, (+, 0, -)

A judge should consider each of these and whether the exhibitor met this parameter will give a (+) or did not consider the parameter evident in the ride (-). Accordingly a horse that does all of these (receives a (+) in all 4 categories) would be awarded

a +2 for the artistic impression. While a ride that does none of these (-) for all categories would conversely receive a -2 for artistic impression.

(3) Required Maneuvers. The required maneuvers include four (4) consecutive spins to the left, four (4) consecutive spins to the right, three (3) stops, and at least one (1) lead change in both directions. The technical judge(s) will ascertain if all requirements are met using the Freestyle Score Sheet. Failure to perform all of the required maneuvers will result in a score of 0.

(4) Penalty Application and Maneuver Scoring. The following shall result in a score of 0; failure to perform all the required maneuvers, fall to the ground by the horse or rider, balking, refusal of command, running away where it is obviously not part of the performance, equipment failure that delays the pattern even if the failure is part of the costume or a prop, and exceeding the four (4) minute time limit. (Show management should be responsible for timing and verifying the length of performances). However, not to be considered for a score of 0; use of two hands, changing of hands, use of no hands on the reins, altering the tension of the reins with a romal, or the inclusion of nontraditional, cued, or trained responses. For example, a horse taught to lie down as part of the performance is not to be considered a fall to the ground. Since no set pattern is specified in Freestyle, inclusion of maneuvers not required must not be considered a penalty situation.

(a) Judges are asked to apply more liberal guidelines in deciding what equipment/tack is allowable in the freestyle class. All equipment must meet general guidelines regarding mouthpiece size, shank length, port height, curb chain width and flatness or any other aspect that would affect whether it would be considered abusive or not. Not to be considered for disqualification would include:

1. Rope mouthpieces, if of adequate diameter ($\frac{5}{16}$ " soft and non-abrasive.
2. Cavisons, if used as part of a traditional English presentation or elsewhere, if appropriate, as long as they are loose and not the dropped style.
3. Slinkies or other head covering as long as they allow free movement of the jaw and the horse's vision is not impaired.
4. A bridleless presentation with a neck rope/reins, as long as the neck rope is smooth and loose. A judge is encouraged to halt any ride when safety and control becomes a concern.
5. Other untraditional equipment is allowable at the judge's discretion, considering its abusiveness or suitability. Exhibitors are encouraged to discuss any special equipment with a judge prior to the class as to its suitability.

(b) Jogging is allowed in Freestyle if it is in an obvious part of the performance. However, in an instance where a jog should not be present, as in exiting a rollback or a canter departure, the proper penalty should be applied.

(c) All situations which result in a no score according to NRHA rules for judging are applicable in Freestyle. Penalties, which would result in a no score, would include; any act of abuse to the horse or any animal used in Freestyle, any act of unsportsmanlike conduct, the use of illegal equipment or failure to provide horse and equipment to the appropriate judge for inspection.

(d) All five (5) point penalties apply in Freestyle except holding the saddle with the free hand. Also, the inclusion of an obvious cued or trained maneuver (i.e. a rear) should not be considered a blatant disobedience. The exhibitors will only be judged astride. Therefore, any movements performed off the horse must only be considered in the artistic impression score.

(e) Two (2) point penalties must be applied for freezing up in spins or rollbacks, and for break of gait. However, no penalty shall apply to markers or walking to the center for a departure.

(f) All lead penalties apply in the case where the judge is certain the exhibitor has not asked the horse to be on the incorrect lead. Typically it is easy to discern between a counter canter demonstration and a horse failing to respond to a rider's lead change command. In the unusual instance a judge is not clear as to whether a horse is failing to comply with the rider's lead command or demonstrating a counter canter, the benefit of doubt should always go to the rider as with all NRHA penalties.

(g) Failure to remain a minimum of 20 feet from the wall or fence shall not result in a ½ point penalty. However, fencing a horse to stops is not desirable and judges are encouraged to reflect this by reducing the maneuver score (i.e. a horse stopping within 10 feet in front of the fence should not be considered for a positive score on the stop.)

(h) When a stop is followed by a rollback or a backup it should be considered as one maneuver. If a stop is followed by a canter, jog or other transitional maneuvers, the stop is to be scored independently. Exhibitors are required to perform at least 4 consecutive spins. In the even an additional consecutive spins are performed, the maneuver score should reflect the quality of all the spins and an increased degree of difficulty. Several consecutive lead changes may be scored individually or as a group. When scoring consecutive lead changes as a group, a maneuver score must be assessed for each directional change reflecting their overall quality and degree of difficulty.

(i) Non-required or transitional maneuvers that add or detract from the technical merit of the ride should be scored and averaged as the overall score in the eighth box of the Freestyle Score Sheet (See Figure #9.)

(j) Circles may be evaluated in conjunction with a required maneuver such as a lead change or a stop, or at the judge(s) discretion may be scored separately as a transitional maneuver. The fact that circles are not required maneuvers

is not to diminish their importance in providing the exhibitor a method to demonstrate a horse's ability to guide and willingness to be controlled.

(k) When judging Freestyle, judges have the option of conference and/or videotape review when major penalties (five (5) point, 0 score and no score) occur and should follow the procedures as set forth in the *NRHA Handbook*. In any instance where a judge is uncertain as to whether or not a penalty has occurred, the benefit of doubt should always go to the rider. ♦

Notes



NRHYA

VARSITY REINING CLUB

- Showcase your efforts outside of the show pen.
- Join today to earn points, prizes and scholarships!

Go to vrc.nrhya.com for more information or call 405-946-7400.

Notes

Figure #1 - Bit Measurements

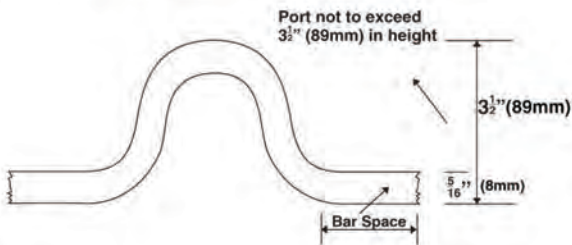

Mouthpiece bar space no less than $\frac{5}{16}$ " (8mm) in diameter, and must not be wire wrapped

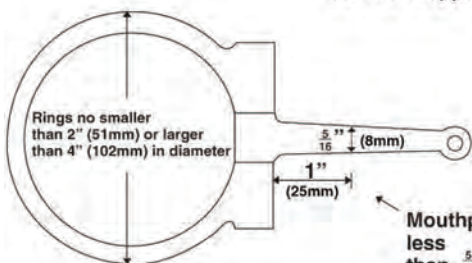

Mouthpiece no less than $\frac{5}{16}$ " (8mm), measured 1" (25mm) from the cheek, constructed from smooth round material

Measured from the inside bottom of the top ring

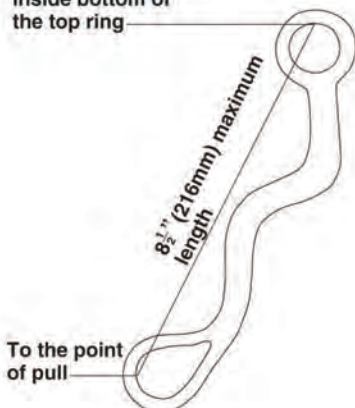

Figure #2 - Bit Measurements

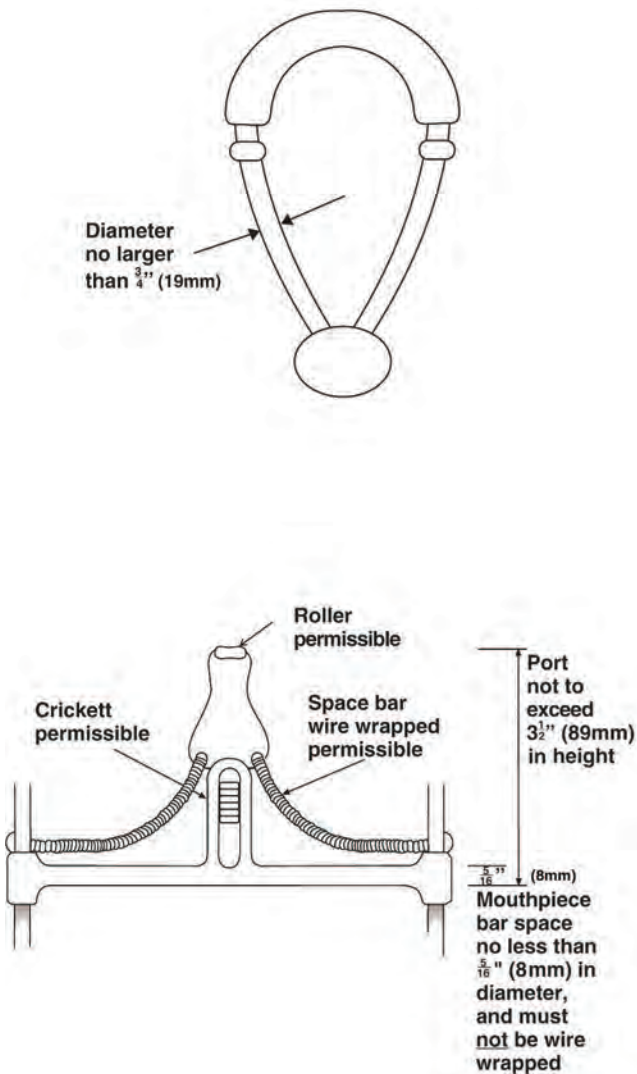

Figure #3A - Over/Under Spin

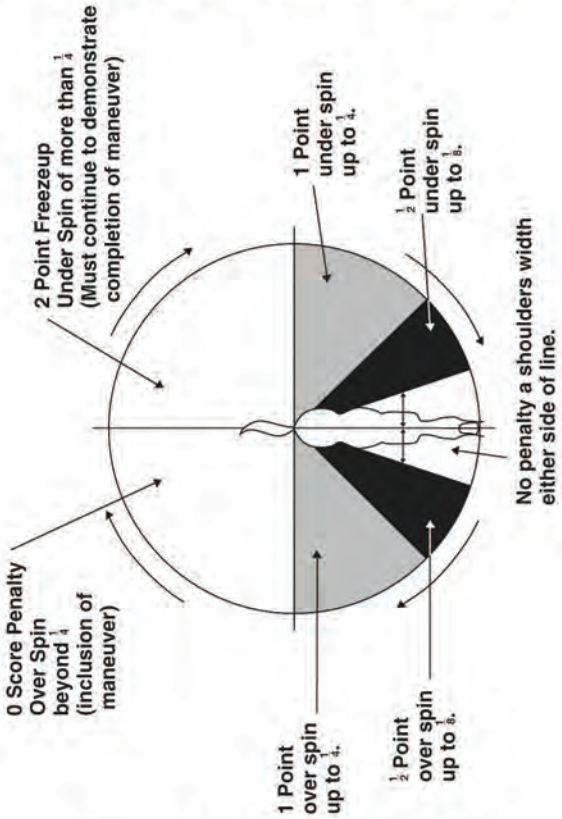
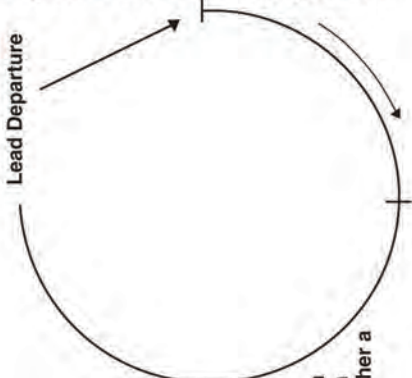

Figure #3B - Lead Departure



Stopping in the first $\frac{1}{4}$ circumference of a circle after a canter departure is NOT to be considered an inclusion on a maneuver, rather a break of gait penalty shall apply.

Figure #4 - Out of Lead/Delayed Change

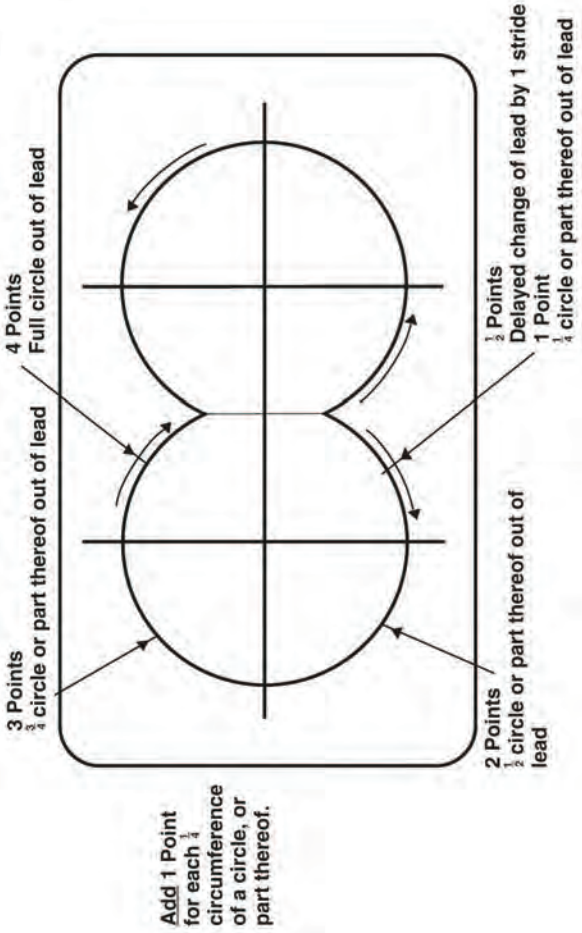

Figure #5 - Jogging

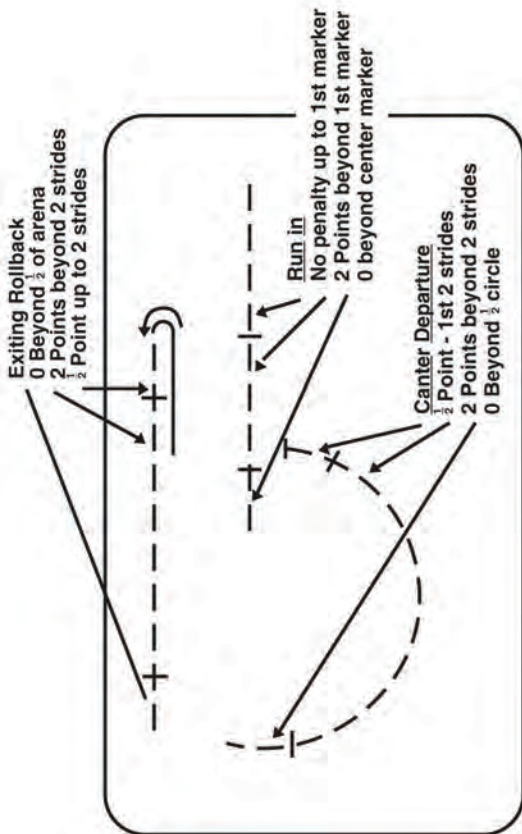

Figure #6 - Out of Lead on Run-around

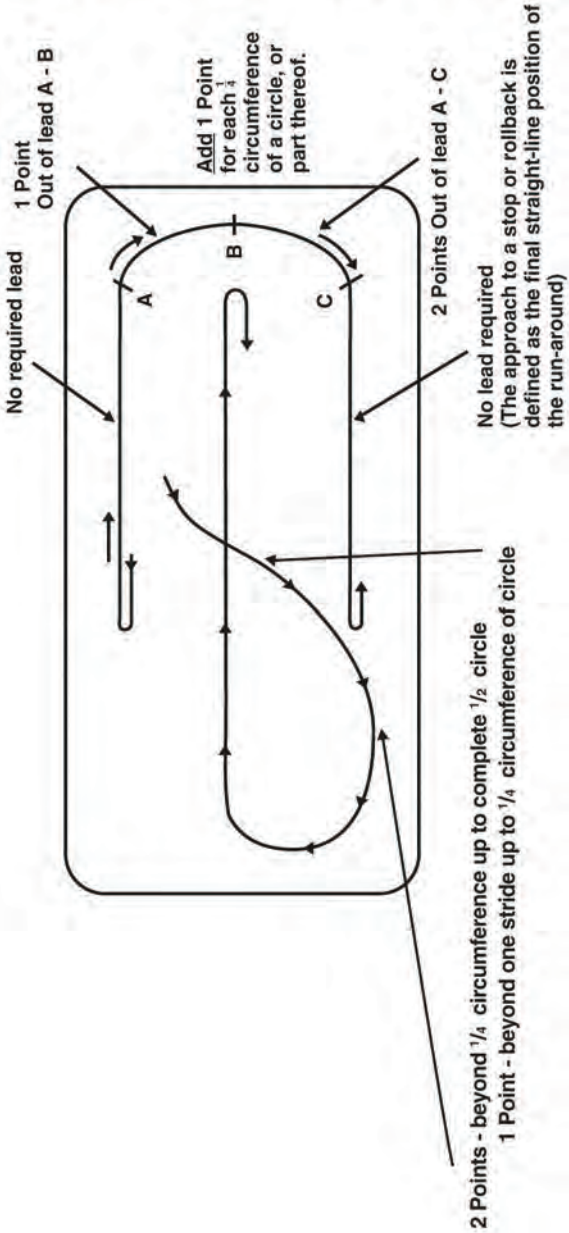
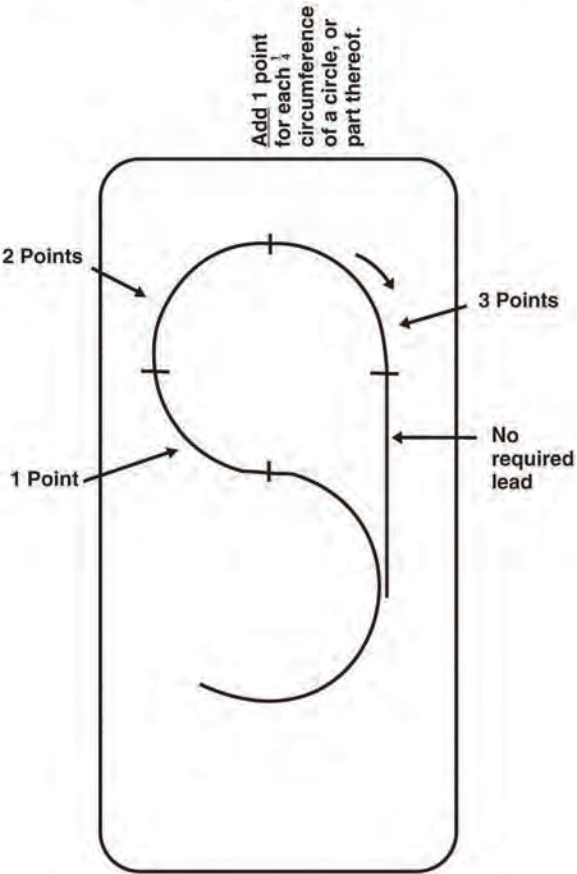

Figure #7 - Out of Lead on Partial Circle Leading to Run-down



NRHA STATEMENT OF POLICY 13-08-37

NRHA WORLDWIDE ELIGIBILITY POLICY FOR SHOW
YEAR: 1/1/2014–12/31/2014.

See the NRHA website for complete and most current policy

Category 1

CLASS NAME	CLASS #	EARNINGS CAP	CATEGORIES INCLUDED	YEARS
Intermediate Open	1200	\$17,500	1,2,4,5,6,8	1/1/2012–12/31/2013
Limited Open	1301	\$10,000	1,2,4,5,6,8	Lifetime
Rookie Professional	1350	\$2,500	1,2,3,4,5,6,7,8,9	Lifetime
Intermediate Non Pro	1500	\$10,000	1,2,4,5,6,8	1/1/2012–12/31/2013
Limited Non Pro	1600	\$10,000	1,2,4,5,6,8	Lifetime
Novice Horse Level 1	1700/1800	\$5,000	1,2,4,5,6,8	Lifetime
Novice Horse Level 2	1750/1850	\$25,000	1,2,4,5,6,8	Lifetime

Category 2 & 6

CLASS NAME	CLASS #	EARNINGS CAP	CATEGORIES INCLUDED	YEARS
Level 3 Open	2200	\$100,000	1,2,6,8	1/1/2012–12/31/2013
Level 2 Open	2300	\$35,000	1,2,6,8	1/1/2012–12/31/2013
Level 1 Open	2325	\$35,000	1,2,4,5,6,7,8,9	Lifetime
Level 3 Non Pro	2500	\$50,000	1,2,6,8	1/1/2012–12/31/2013
Level 2 Non Pro	2600	\$17,500	1,2,6,8	1/1/2012–12/31/2013
Level 1 Non Pro	2625	\$17,500	1,2,4,5,6,7,8,9	Lifetime

Category 3

CLASS NAME	CLASS #	POINTS CAP	CATEGORIES INCLUDED	YEARS
Youth Rookie	3300	25	Exclude Youth 10 & Under (SS)	Lifetime

Category 5

CLASS NAME	CLASS #	EARNINGS/POINTS CAP	CATEGORIES INCLUDED	YEARS
Rookie Level 1	5300	\$500/100 youth points (exclude SS)	1,2,4,5,6,8	Lifetime
Rookie Level 2	5310	\$1500/200 youth points (exclude SS)	1,2,4,5,6,8	Lifetime
Intermediate Horse	5750/5850	\$50,000	1,2,4,5,6,8	Lifetime

Category 10

CLASS NAME	CLASS #	EARNINGS/POINTS CAP	CATEGORIES INCLUDED	YEARS
Ride & Slide Open 2	10200	\$500/50 pts (exclude SS)	1,2,3,4,5,6,7,8,9,10	Lifetime
Ride & Slide Open 1	10100	\$0/0 points (exclude SS)	1,2,3,4,5,6,7,8,9	Lifetime
Ride & Slide Non Pro 2	10201	\$500/50 pts (exclude SS)	1,2,3,4,5,6,7,8,9,10	Lifetime
Ride & Slide Non Pro 1	10101	\$0/0 points (exclude SS)	1,2,3,4,5,6,7,8,9	Lifetime
Ride & Slide Youth 2	10202	\$500/50 pts (exclude SS)	1,2,3,4,5,6,7,8,9,10	Lifetime
Ride & Slide Youth 1	10102	\$0/0 points (exclude SS)	1,2,3,4,5,6,7,8,9	Lifetime
Green Reiner 1	10002	\$100/25 youth pts (exclude SS)/50 green pts	1,2,3,4,5,6,7,8,9	Lifetime
Green Reiner 2	10001	\$100/25 youth pts(exclude SS)/100 green pts.	1,2,3,4,5,6,7,8,9	Lifetime

Notes

Notes

International Shipping!

NRHA GEAR

Est. 1966



OFFICIAL NRHA MERCHANDISE!

RON'S

Corporate Product Specialist

www.ronslogos.com

(949) 728-1420

307-752-0015

www.nrhaoutfitters.com

NATIONAL REINING HORSE ASSOCIATION

HALL OF FAME INDUCTEES:

YEAR INDUCTED: NAME:	YEAR INDUCTED: NAME:
1986 Dale Wilkinson	2001 Frank Costantini, Jr.
1987 None	2002 Miss Cee Blair
1988 R.D. Baker Stretch Bradley Bill Garvey Paul Horn Mickie Glenn Continental King	2003 Linda Matthews Dodsons Little Star Gunner Topsail Whiz
1989 C.T. Fuller Kaye Potts Joe Cody	2004 Eleuterio Arcese Pat Feuerstein Charles Smith Dick & Barb Waltenberry Smart Chic Olena
1990 Guy Gauthier Paul Schuh Clayton Woosley Enterprise Lady Glenda Echols	2005 Clint Haverty
1991 High Proof	2006 Rocky Dare Doug Milholland
1992 Banker Bar Leo Mr Doin Good Hollywood Smoke Bob Anthony Bill Horn Bob Loomis Jim Willoughby	2007 Keith Bradley
1993 Cee Leo Step Hollywood Jac 86 Miss White Trash Dick Pieper	2008 Dr. Jim Morgan, DVM Mr Gun Smoke Taris Little Vintage Miss Okie Too American Quarter Horse Association
1994 John Snobelen Clark Bradley	2009 Roger Brazeau Mike Flarida Custom Crome Mega Ditto
1995 Cee Blair Sailor Great Pine	2010 Jack Brainard John Hoyt Rest Stop Nu Chex To Cash
1996 Diamonds Sparkle Topsail Cody Trashadeous	2011 Shawn Flarida Bob Kiser Mandy McCutcheon Ronnie Sharpe Boomernic Collena Chic Olena Shining Spark Wimpys Little Step
1997 Be Aech Enterprise Nifty Jodieann	2012 Wimpys Little Chic
1998 Great Simon Sez Mr Feelin Good	2013 Carol Trimmer Rick Weaver
1999 None	
2000 Dr. Tim Bartlett Richard Greenberg Tim McQuay Hollywood Dun It	

A. General

To rein a horse is not only to guide him, but also to control his every movement. The best reined horse should be willingly guided or controlled with little or no apparent resistance and dictated to completely.

Jim Willoughby
NRHA Hall of Fame Inductee

NRHA 

NATIONAL REINING HORSE ASSOCIATION

3000 NW 10th Street, Oklahoma City, OK 73107-5302

405-946-7400 • Fax 405-946-8425 • nrha.com