

1. – 7. Juni 2022

Mega-Event

auf Gut Matheshof in Kreuth

Int. Bayerische Meisterschaften der VWB

Freestyle Reining

4-fach AQHA-Show

NRHA-Show

VWB-Show

Qualifikation zur

66.000 Euro VWB Series

VWB Ranch Rail

18.000 Euro Preisgeld

40 Jahre VWB Feier

Nähere Infos unter

www.westernreiten-online.de

Veranstalter: Vereinigung der Westernreiter in Bayern e.V.



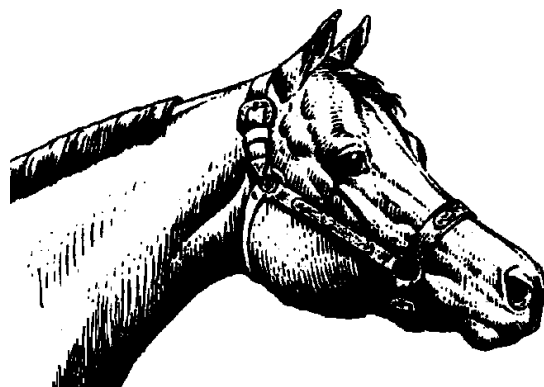

PATTERNBOOK

BAYERISCHE

MEISTERSCHAFTEN

1.-7. Juni

Bavarian Golden Series

NRHA (USA)-Show

VWB Kat I-Show

4-fach AQHA-Show

Aktuelle Show-Infos unter westernreiten-online.de

AMERICAN
QUARTER
HORSE
ASSOCIATION

NRHA



Patternübersicht

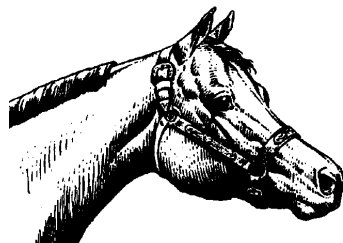

Reining

8347	VWB	Novice Jugend Reining	VWB-Pattern	6
8348	VWB	Jugend Reining	VWB-Pattern	8
9340	VWB	Einsteiger Reining	VWB-Pattern	14
7340	VWB	Amateur Reining	VWB-Pattern	11
6340	VWB	Offen Reining	VWB-Pattern	15
5055	VWB	Bavarian Golden Series Reining	VWB-Pattern	9
1341	AQHA	Open Junior Reining	AQHA-Pattern	6
1342	AQHA	Open Senior Reining	AQHA-Pattern	4
1347	AQHA	Open Green Reining	AQHA-Pattern	8
2340	AQHA	Amateur Reining	AQHA-Pattern	6
3340	AQHA	Novice Amateur Reining	AQHA-Pattern	8
4340	AQHA	Youth Reining	AQHA-Pattern	5
1100	NRHA	Open Trophy	NRHA-Pattern	1
1200	NRHA	Intermediate Open	NRHA-Pattern	11
1700	NRHA	Novice Horse Open Level 1	NRHA-Pattern	2
1400	NRHA	Non Pro Trophy	NRHA-Pattern	12
1500	NRHA	Intermediate Non Pro	NRHA-Pattern	6
1600	NRHA	Limited Non Pro	NRHA-Pattern	13
3100	NRHA	Youth 14-18	NRHA-Pattern	6
3200	NRHA	Youth 0-13	NRHA-Pattern	5

Western Riding

6360	VWB	Offen Western Riding	VWB-Pattern	3
7360	VWB	Amateur Western Riding	VWB-Pattern	1
9360	VWB	Einsteiger Western Riding	VWB-Pattern	2
5057	VWB	Bavarian Golden Series Western Riding	VWB-Pattern	9
1360	AQHA	Open Western Riding	AQHA-Pattern	4
1363	AQHA	Green Western Riding	Green-Pattern	9
2360	AQHA	Amateur Western Riding	AQHA-Pattern	7

Ranch Riding

6430	VWB	Offen Ranch Riding	AQHA-Pattern	9
7430	VWB	Amateur Ranch Riding	AQHA-Pattern	8
9430	VWB	Einsteiger Ranch Riding	AQHA-Pattern	3
8430	VWB	Jugend Ranch Riding	AQHA-Pattern	1
1430	AQHA	Open Ranch Riding	AQHA-Pattern	4
2430	AQHA	Amateur Ranch Riding	AQHA-Pattern	2
5054	VWB	Bavarian Golden Series Ranch Riding	Seite	20

Patternübersicht



Jungpferde

6840	VWB	Jungpferde-Reining	VWB-Pattern	1
6880	VWB	Jungpferde-Trail	VWB-Pattern	1
6890	VWB	Jungpferde-Basis	VWB-Pattern	1

Western Combination

6600	VWB	Western Combination Open	VWB-Pattern	1
------	-----	--------------------------	-------------	---

Trail

1381	AQHA	Open Junior Trail	Seite	6
1382	AQHA	Open Senior Trail	Seite	11
1383	AQHA	Green Trail	Seite	8
2380	AQHA	Amateur Trail	Seite	7
2388	AQHA	Amateur Select Trail	Seite	7
3380	AQHA	Novice Amateur Trail	Seite	8
4380	AQHA	Youth Trail	Seite	6
6380	VWB	Offen Trail	Seite	8
6390	VWB	Offen Ranch Trail	Seite	11
6830	VWB	Jungpferde-Cup In-Hand Trail	Seite	9
7380	VWB	Amateur Trail	Seite	7
7390	VWB	Amateur Ranch Trail	Seite	9
9380	VWB	Einsteiger Trail	Seite	6
8387	VWB	Novice Jugend	Seite	12
8388	VWB	Jugend	Seite	12
5050	VWB	Bavarian Golden Series Trail	Seite	10
5056	VWB	Bavarian Limited Series Trail	Seite	10

Showmanship

	VWB	alle Showmanship VWB	Seite	14 / 15
	AQHA	alle Showmanship AQHA	Seite	16
6810	VWB	Jungpferde-Cup	Seite	13
5052	VWB	Bavarian Golden Series Showmanship	Seite	13

Horsemanship

	VWB	alle Horsemanship VWB	Seite	17 / 18
	AQHA	alle Horsemanship AQHA	Seite	18 / 19
5053	VWB	Bavarian Golden Series Horsemanship	Seite	20

Hunt Seat Equitation

	AQHA	alle Hunt Seat Equitation AQHA	Seite	22
--	------	--------------------------------	-------	----

THURSDAY 02.06.2022

#4380 AQHA JUGEND TRAIL
#1381 AQHA JUNIOR TRAIL

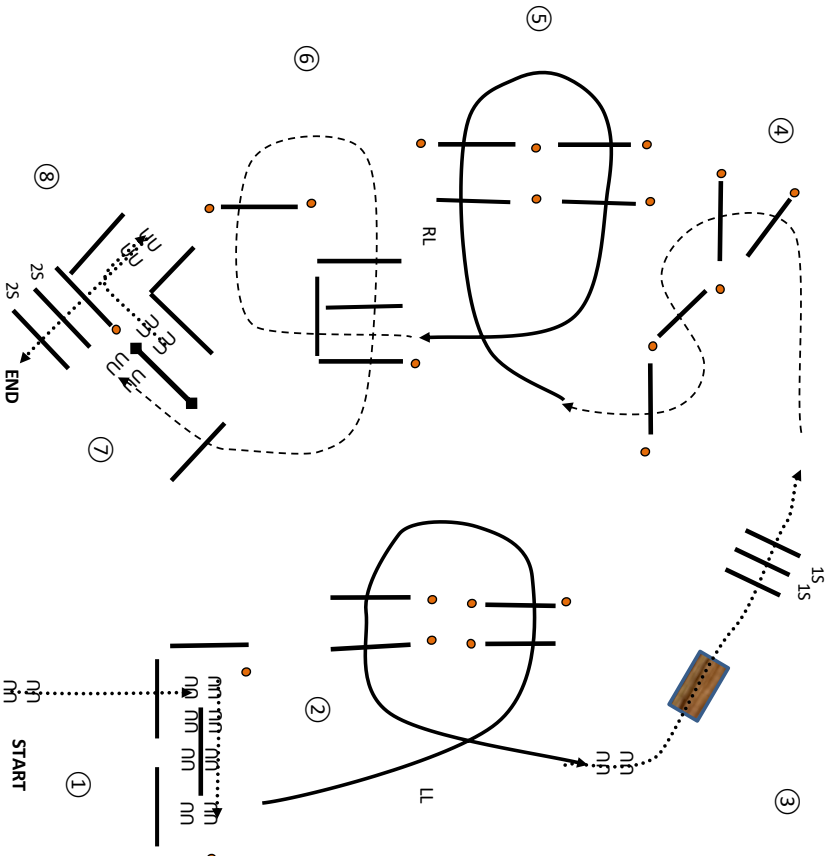

- 1 WALK OVER –SIDEPASS POLE RIGHT
- 2 LL LOPE OVERS
- 3 STOP OR BREAK TO A WALK –BRIDGE-WALK OVERS
- 4 JOG OVERS-SERPENTINE
- 5 RL LOPE OVERS
- 6 JOG OVERS TO GATE
- 7 STOP-RRH OPEN GATE RIDE THROUGH CLOSE
- 8 BACK-L-WALK OVERS

END OF PATTERN

ANNBENNISDESIGN COPYRIGHT 2022
ALL RIGHTS RESERVED

THURSDAY 02.06.2022

#9380 VWB EINSTEIGER TRAIL

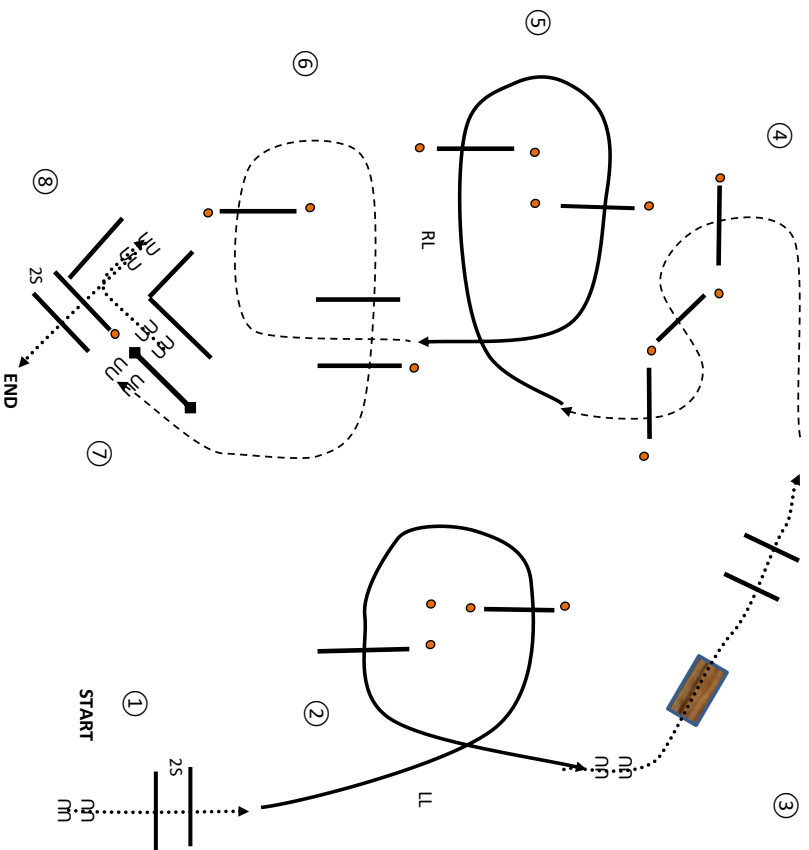

- 1 WALK OVERS
- 2 LL LOPE OVERS
- 3 STOP OR BREAK TO A WALK –BRIDGE-WALK OVERS
- 4 JOG OVERS-SERPENTINE
- 5 RL LOPE OVERS
- 6 JOG OVERS TO GATE
- 7 STOP-RRH OPEN GATE RIDE THROUGH CLOSE
- 8 BACK-L-WALK OVERS

END OF PATTERN

ANNBENNISDESIGN COPYRIGHT 2022
ALL RIGHTS RESERVED

THURSDAY 02.06.2022

#2388 AQHA SELECT AMATEUR TRAIL
#2380 AQHA AMATEUR TRAIL

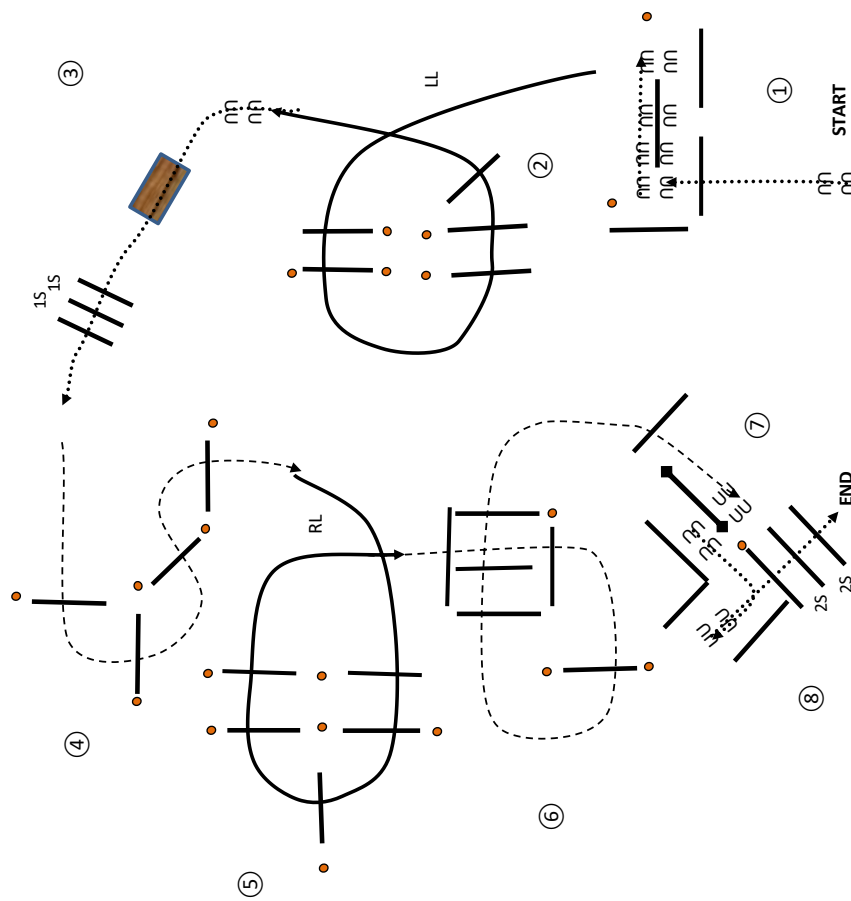

- 1 WALK OVER - SIDEPASS POLE RIGHT
- 2 LL LOPE OVERS
- 3 STOP OR BREAK TO A WALK - BRIDGE - WALK OVERS
- 4 JOG OVERS - SERPENTINE
- 5 RL LOPE OVERS
- 6 JOG OVERS TO GATE
- 7 STOP - RH OPEN GATE RIDE THROUGH CLOSE
- 8 BACK L - WALK OVERS

END OF PATTERN

ANN DENNIS DESIGN COPYRIGHT 2022
ALL RIGHTS RESERVED

FRIDAY 03.06.2022

#7380 VMB AMATEUR TRAIL

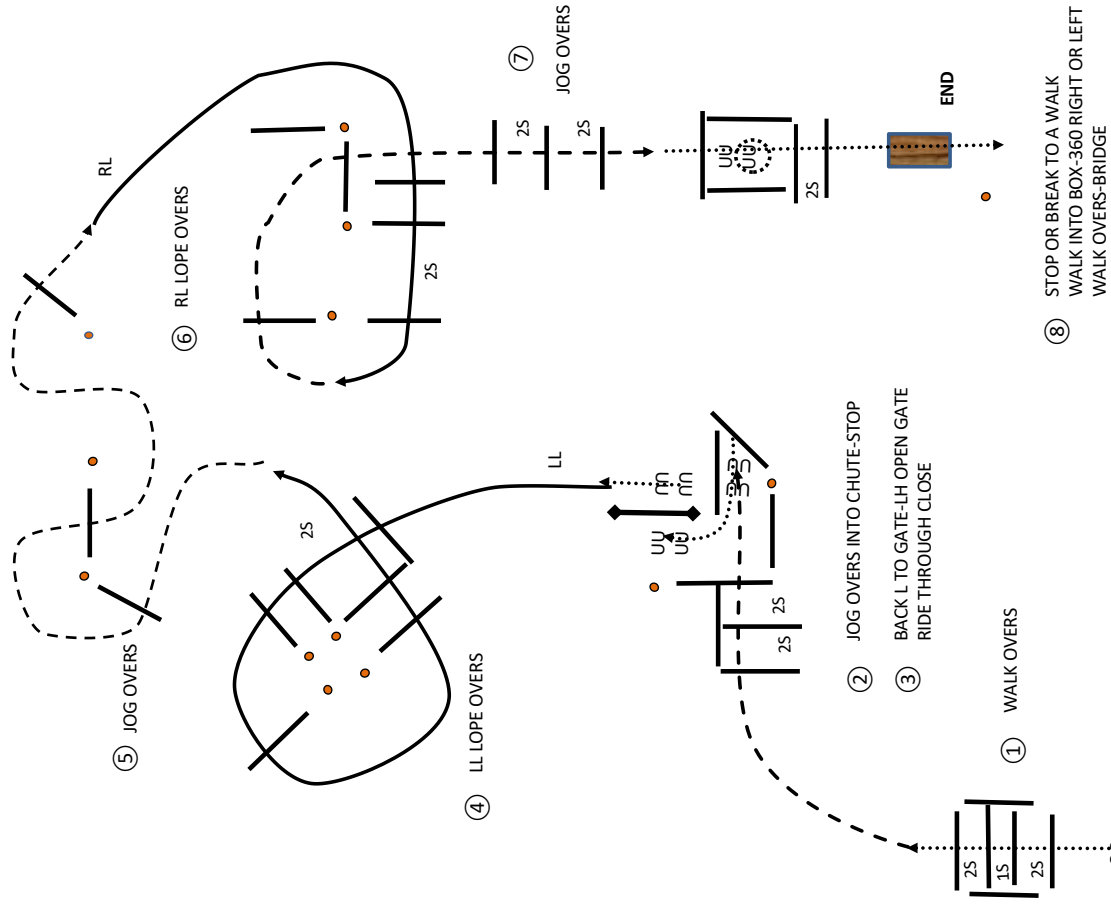

- 1 WALK OVERS
- 2 JOG OVERS INTO CHUTE - STOP
- 3 BACK L TO GATE - LH OPEN GATE RIDE THROUGH CLOSE
- 4 LL LOPE OVERS
- 5 JOG OVERS
- 6 RL LOPE OVERS
- 7 JOG OVERS
- 8 STOP OR BREAK TO A WALK WALK INTO BOX - 360 RIGHT OR LEFT WALK OVERS - BRIDGE

ANN DENNIS DESIGN COPYRIGHT 2022
ALL RIGHTS RESERVED

FRIDAY 03.06.2022

#3380 AQHA NOV AMATEUR TRAIL
#1383 AQHA GREEN TRAIL OPEN

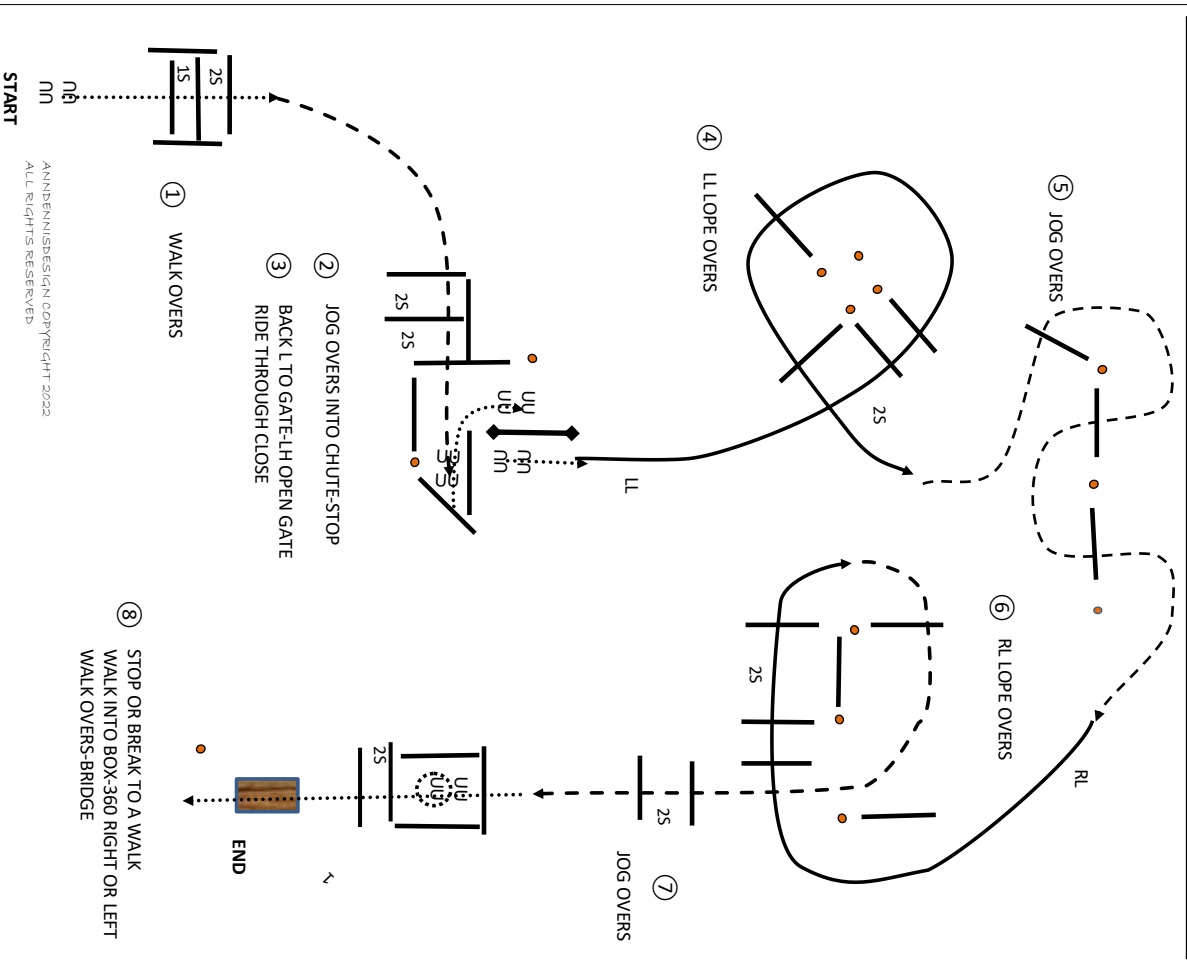

ANNDENNISDESIGN COPYRIGHT 2022
ALL RIGHTS RESERVED

SATURDAY 04.06.2022

#6380 VWB TRAIL ALL AGES OFFEN

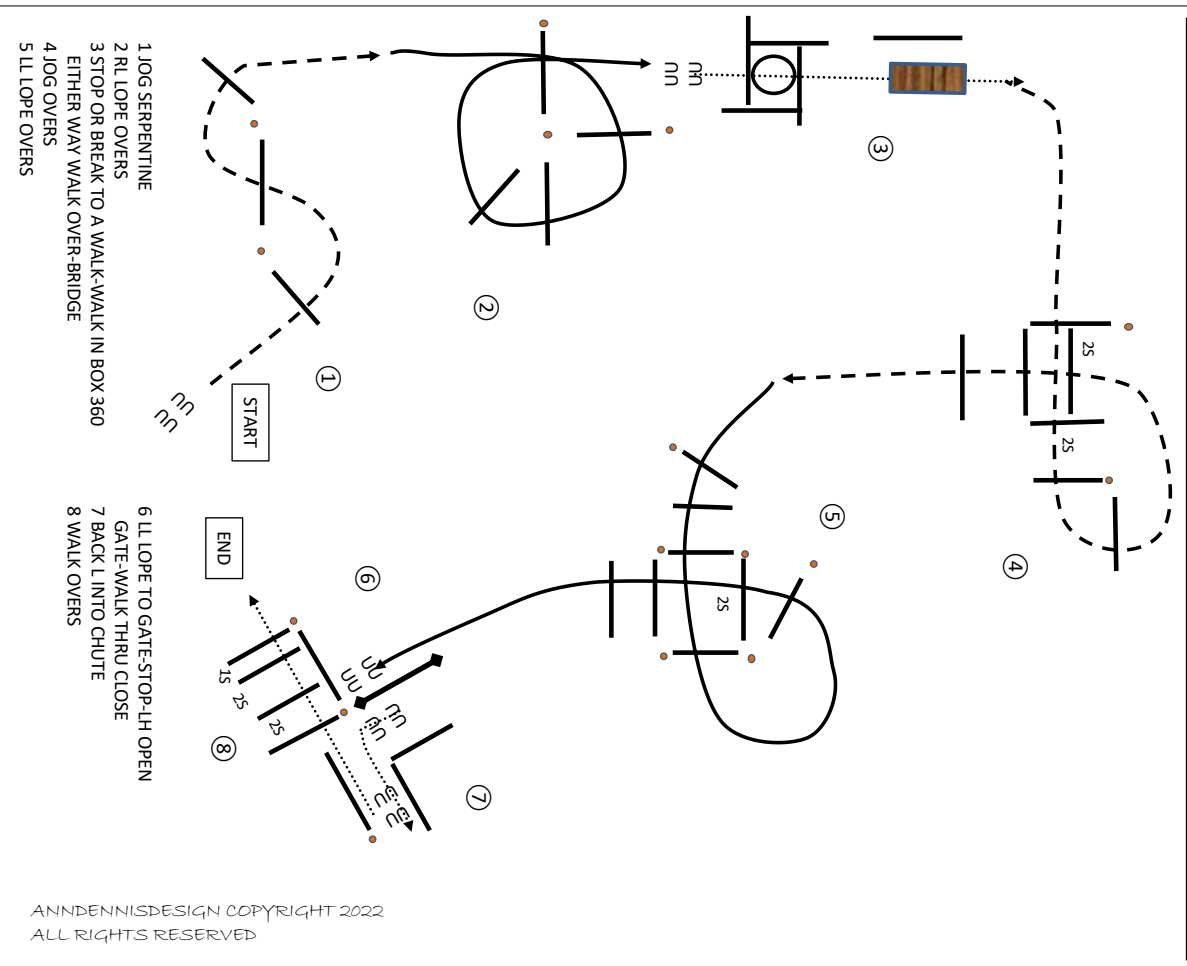

1 JOG SERPENTINE
2 RL LOPE OVERS
3 STOP OR BREAK TO A WALK-WALK IN BOX 360
EITHER WAY WALK OVER-BRIDGE
4 JOG OVERS
5 LL LOPE OVERS

6 LL LOPE TO GATE-STOP-LH OPEN
GATE-WALK THRU CLOSE
7 BACK L INTO CHUTE
8 WALK OVERS

ANNDENNISDESIGN COPYRIGHT 2022
ALL RIGHTS RESERVED

SATURDAY 04.06.2022

#6380 VWB TRAIL IN HAND JUNGPERDE

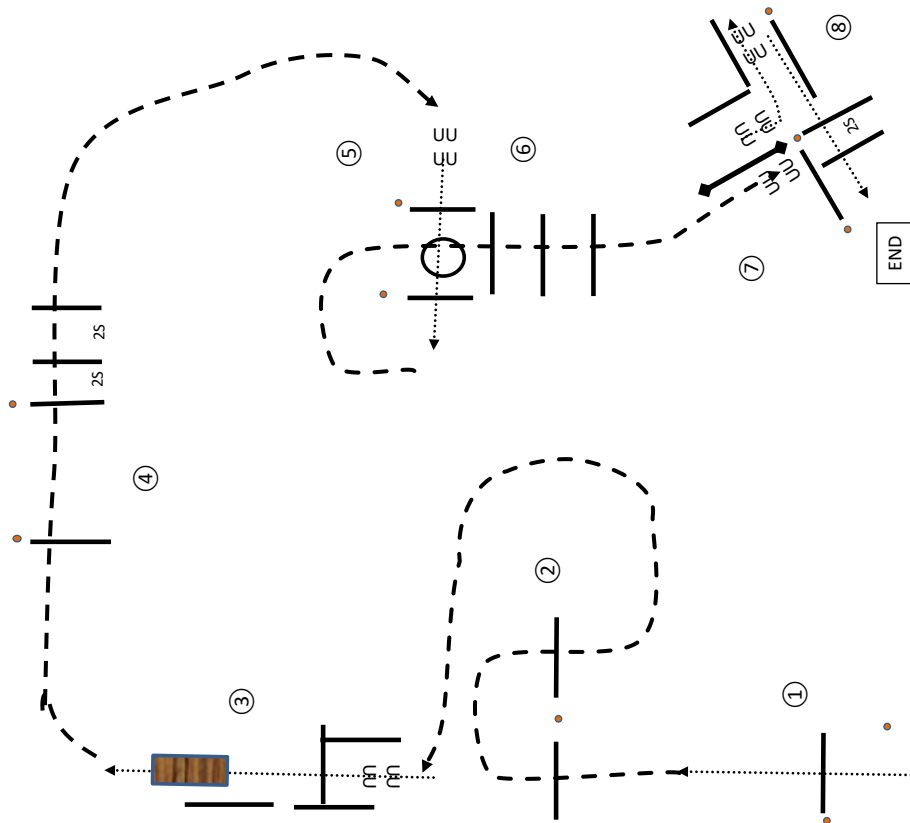

- 1 WALK OVER
- 2 TROT SERPENTINE
- 3 STOP OR BREAK TO A WALK - WALK OVER-BRIDGE
- 4 TROT OVERS
- 5 STOP OR BREAK TO A WALK-WALK OVER-360 RIGHT WALK OVER

- 6 TROT OVERS
- 7 TROT TO GATE-STOP-LH OPEN GATE-WALK THRU CLOSE
- 8 BACK L INTO CHUTE-WALK OVERS

ANNDENNISDESIGN COPYRIGHT 2022
ALL RIGHTS RESERVED

SATURDAY 04.06.2022

#7390 VWB RANCH TRAIL AMATEUR

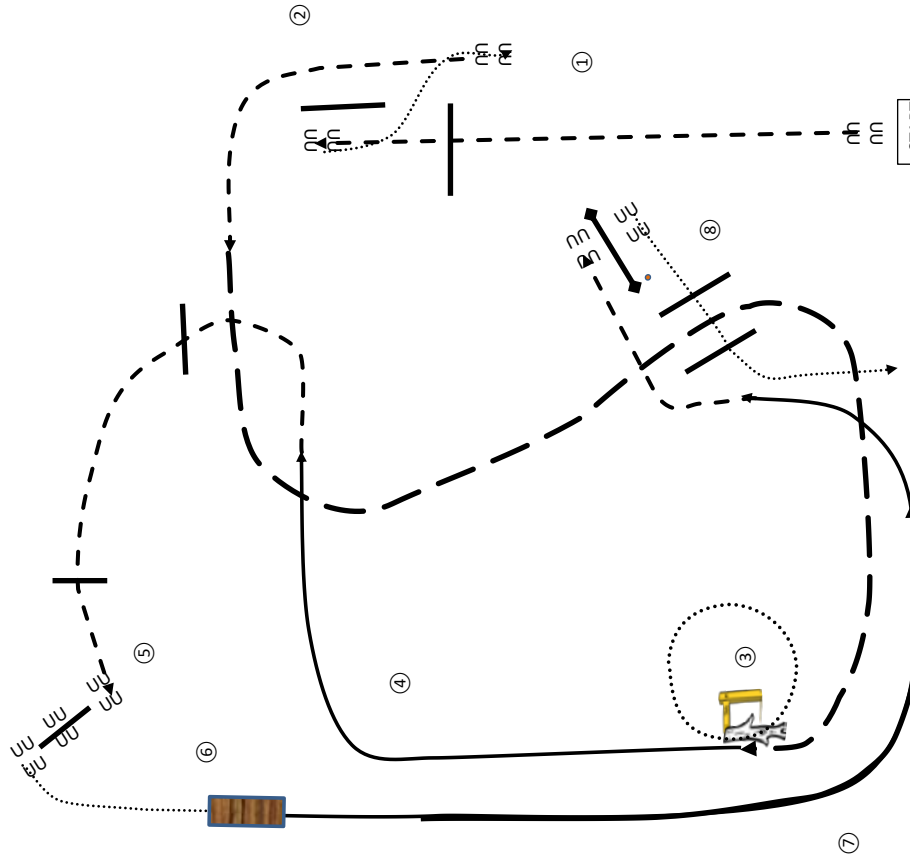

- 1 TROT IN OVER POLE-STOP BACK THROUGH OPENING
- 2 TROT TO EXTENDED TROT-STOP AT LOG DRAG
- 3 PICK UP ROPE-DALLY-DRAG LOG CIRCLE RIGHT AT WALK OR TROT PUT LOG BACK-HANG ROPE
- 4 RL LOPE -BREAK TO TROT-TROT OVERS
- 5 STOP AT LOG-SIDEPASS LOG RIGHT-WALK
- 6 WALK OVER BRIDGE
- 7 LL LOPE -EXTENDED LL LOPE-COLLECTED LLOPE-BREAK TO A TROT
- 8 TROT TO GATE STOP-RH GATE OPEN WALK THROUGH CLOSE-WALK OVERS

ANNDENNISDESIGN COPYRIGHT 2022
ALL RIGHTS RESERVED

SUNDAY 05.06.2022

#5056 VWB LIMITED SERIES TRAIL

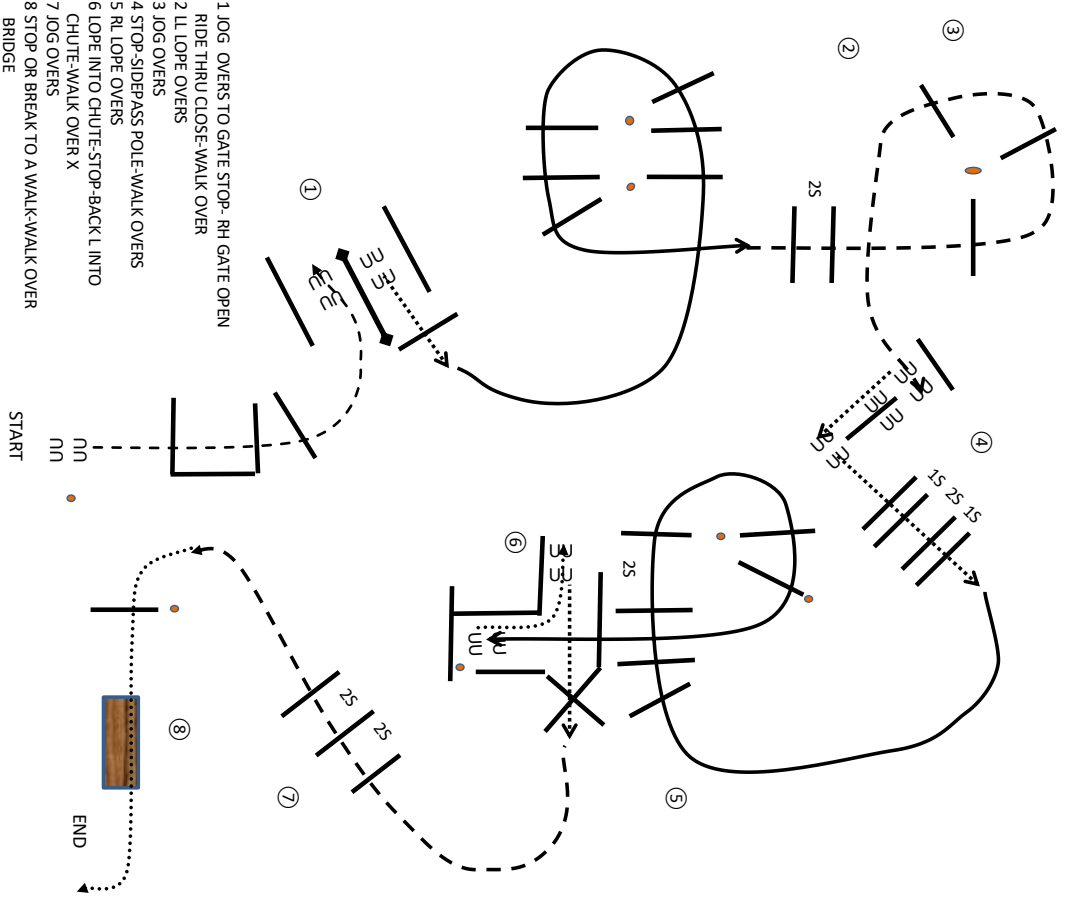

ANDBENNISDESIGN COPYRIGHT 2022
ALL RIGHTS RESERVED

SUNDAY 05.06.2022

#5050 VWB SERIES TRAIL

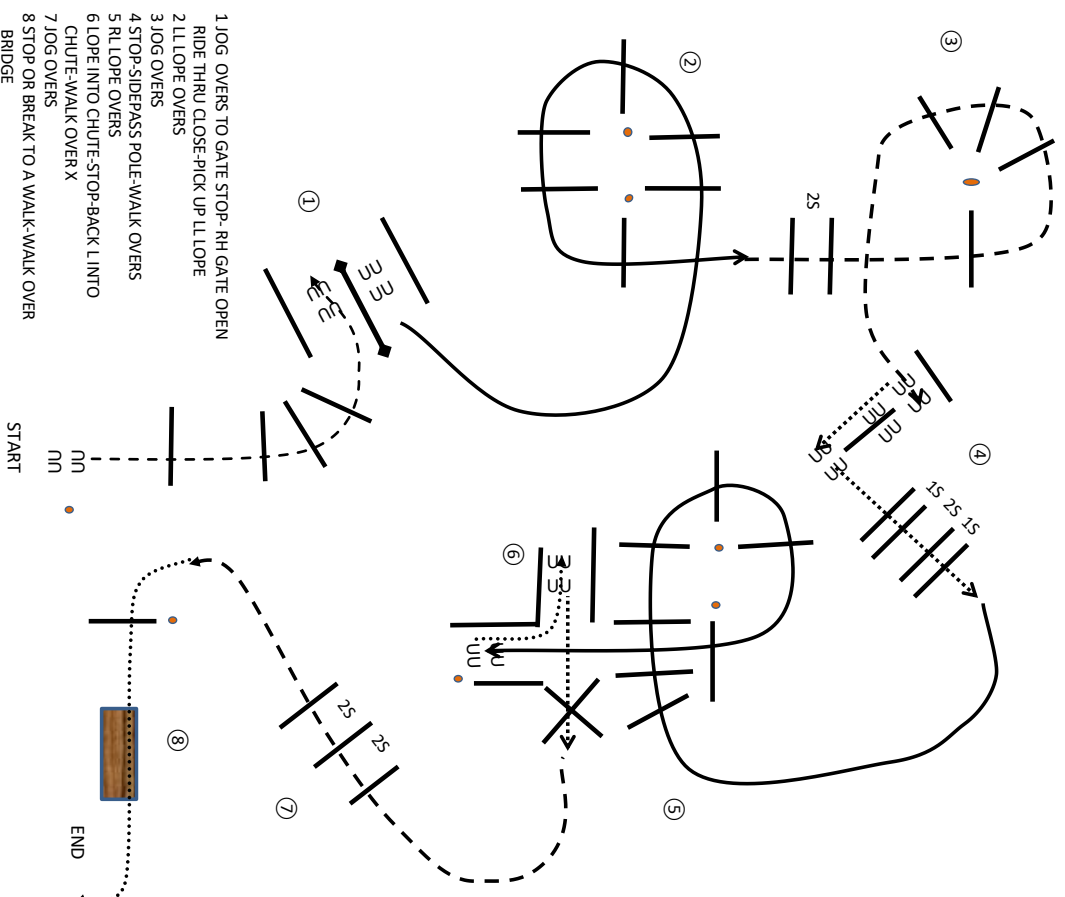

ANDBENNISDESIGN COPYRIGHT 2022
ALL RIGHTS RESERVED

SUNDAY 05.06.2022

#6390 VVB RANCH TRAIL OPEN

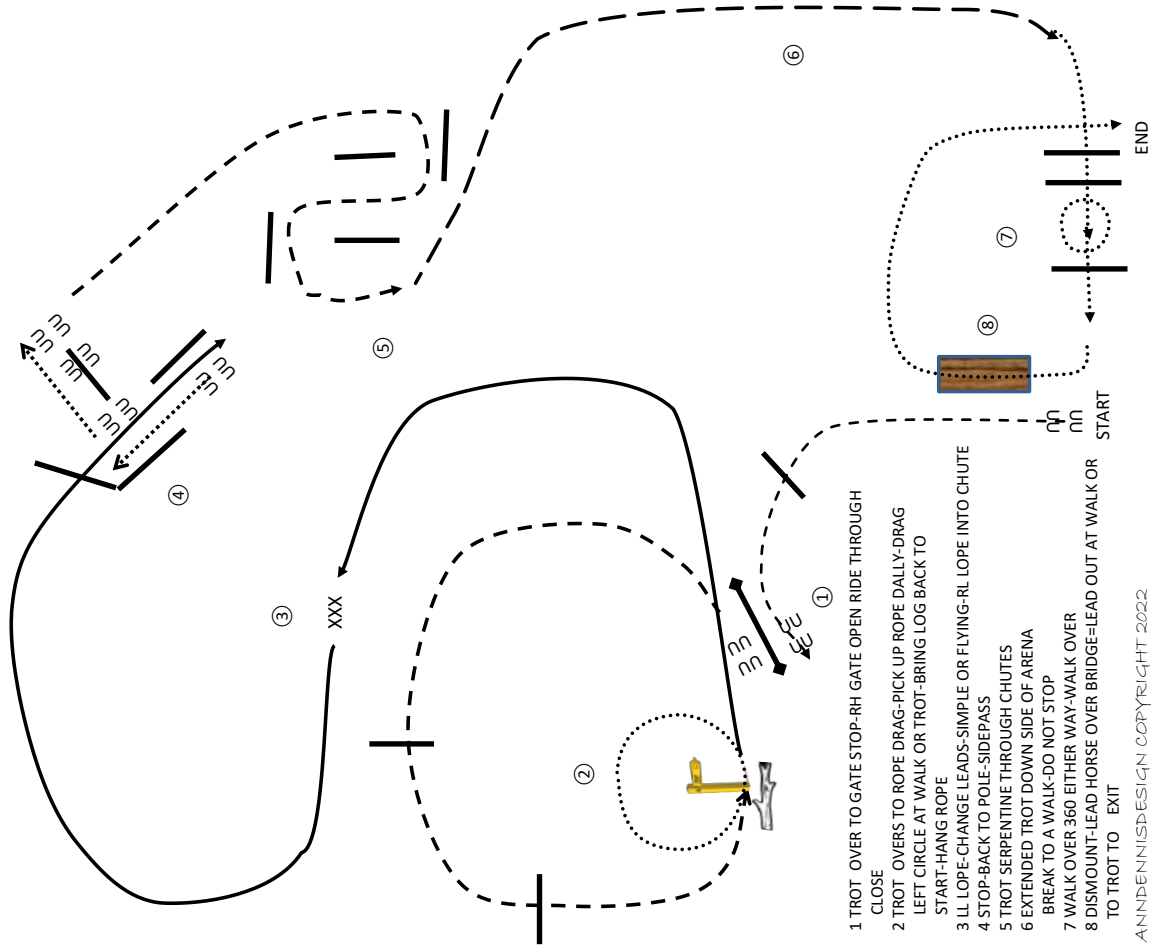

- 1 TROT OVER TO GATE STOP-RH GATE OPEN RIDE THROUGH CLOSE
- 2 TROT OVERS TO ROPE DRAG-PICK UP ROPE DALLY-DRAW LEFT CIRCLE AT WALK OR TROT-BRING LOG BACK TO START-HANG ROPE
- 3 LL LOPE-CHANGE LEADS-SIMPLE OR FLYING-RL LOPE INTO CHUTE
- 4 STOP-BACK TO POLE- SIDEPASS
- 5 TROT SERPENTINE THROUGH CHUTES
- 6 EXTENDED TROT DOWN SIDE OF ARENA
BREAK TO A WALK-DO NOT STOP
- 7 WALK OVER 360 EITHER WAY-WALK OVER DISMOUNT-LEAD HORSE OVER BRIDGE=LEAD OUT AT WALK OR TO TROT TO EXIT
- 8

ANNDENNISDESIGN COPYRIGHT 2022
ALL RIGHTS RESERVED

MONDAY 06.06.2022

#1382 AQHA SENIOR TRAIL

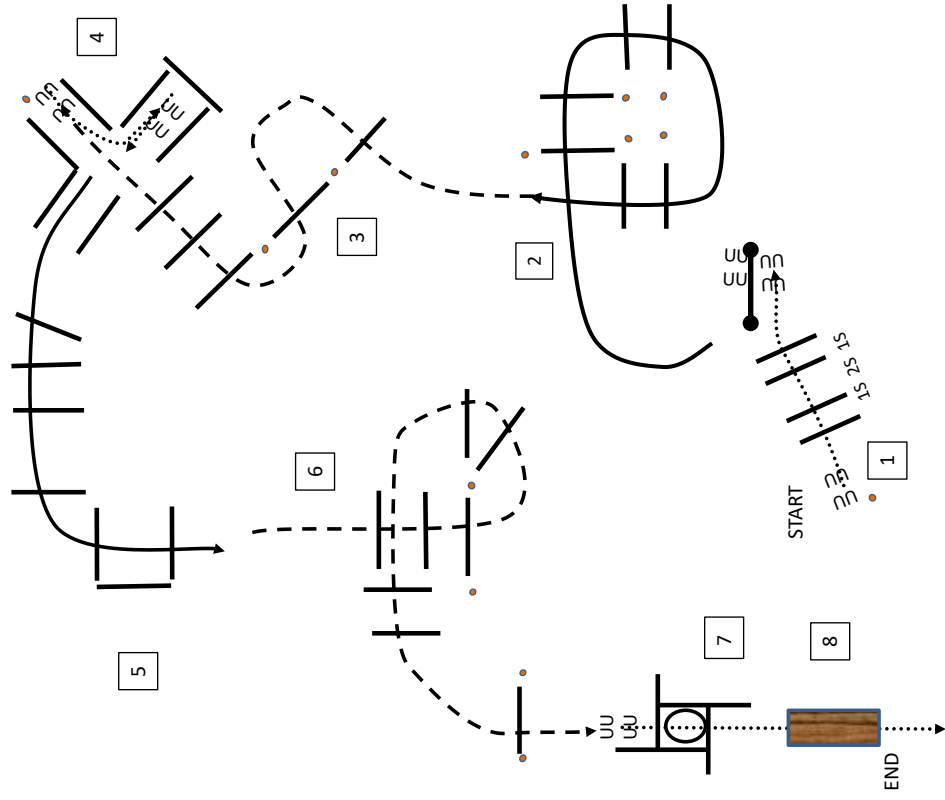

- 1 WALK OVERS-LH GATE OPEN RIDE THROUGH CLOSE
- 2 RL LOPE OVERS
- 3 JOG OVERS-SERPENTINE-INTO CHUTE-STOP
- 4 BACK L-LL LOPE OUT
- 5 LL LOPE OVERS
- 6 JOG OVERS
- 7 STOP OR BREAK TO A WALK-WALK INTO BOX 360 EITHER WAY
- 8 WALK OVER-BRIDGE

ANNDENNISDESIGN COPYRIGHT 2022
ALL RIGHTS RESERVED

MONDAY 06.06.2022

#8387 VWB NOV JUGEND

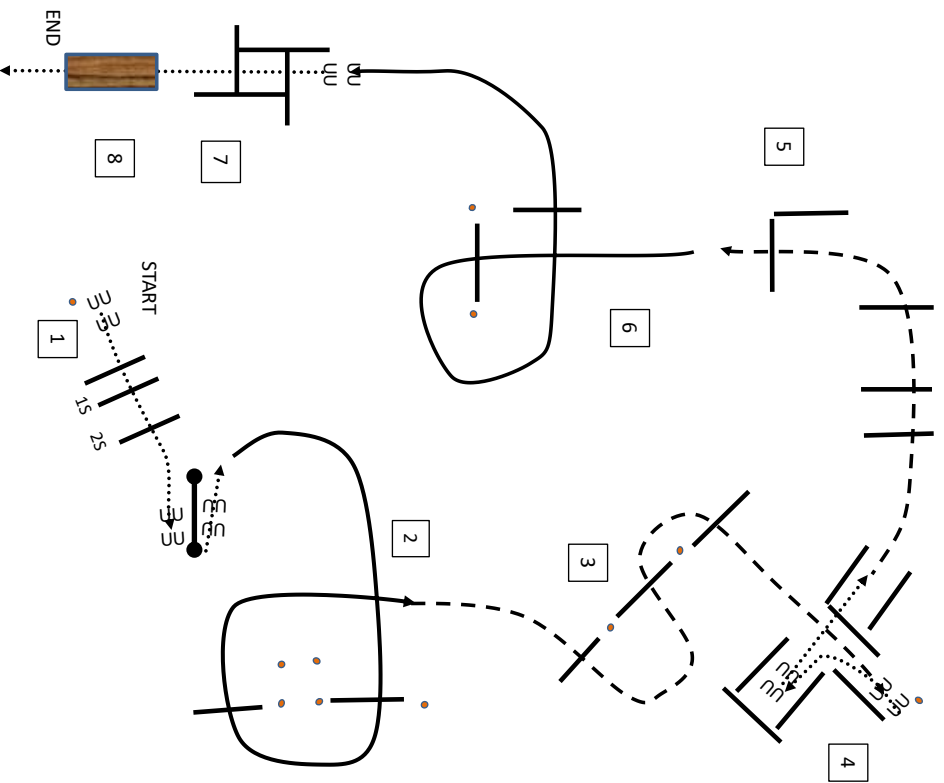

- 1 WALK OVERS-LH GATE OPEN RIDE THROUGH CLOSE
- 2 RL LOPE OVERS
- 3 JOG OVERS-SERPENTINE-INTO CHUTE-STOP
- 4 BACK L-WALK OVER
- 5 JOG OVERS
- 6 LL LOPE OVERS
- 7 STOP OR BREAK TO A WALK-WALK OVERS
- 8 BRIDGE

ANDENNISDESIGN COPYRIGHT 2022
ALL RIGHTS RESERVED

MONDAY 06.06.2022

#8388 VWB JUGEND

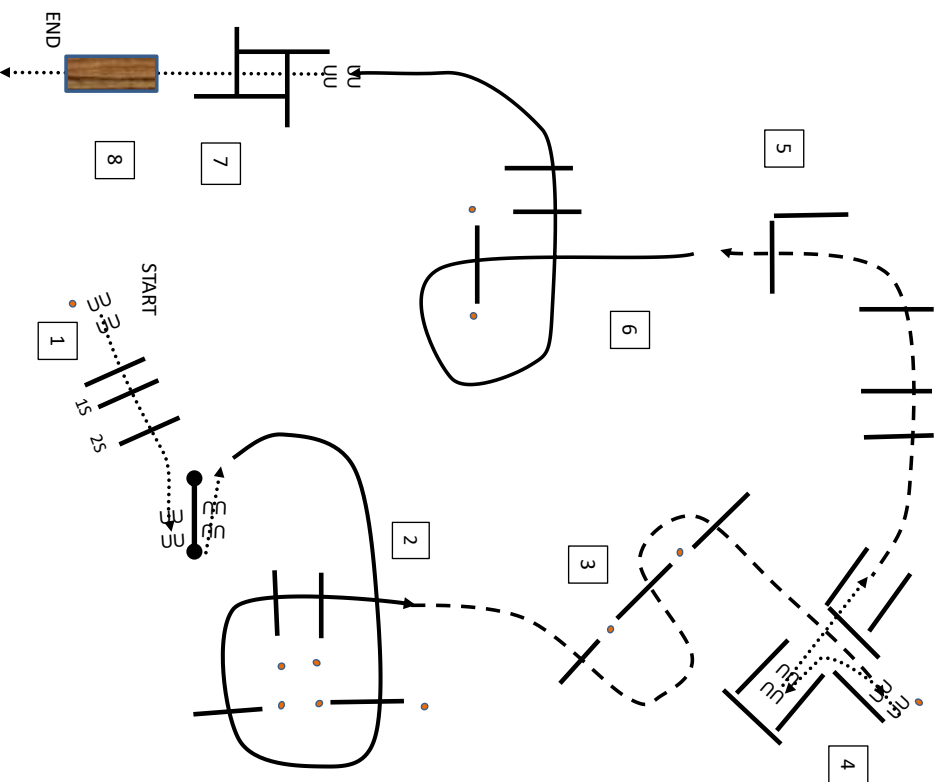

- 1 WALK OVERS-LH GATE OPEN RIDE THROUGH CLOSE
- 2 RL LOPE OVERS
- 3 JOG OVERS-SERPENTINE-INTO CHUTE-STOP
- 4 BACK L-WALK OVER
- 5 JOG OVERS
- 6 LL LOPE OVERS
- 7 STOP OR BREAK TO A WALK-WALK OVERS
- 8 BRIDGE

ANDENNISDESIGN COPYRIGHT 2022
ALL RIGHTS RESERVED

5052 Bavarian Golden Series Showmanship

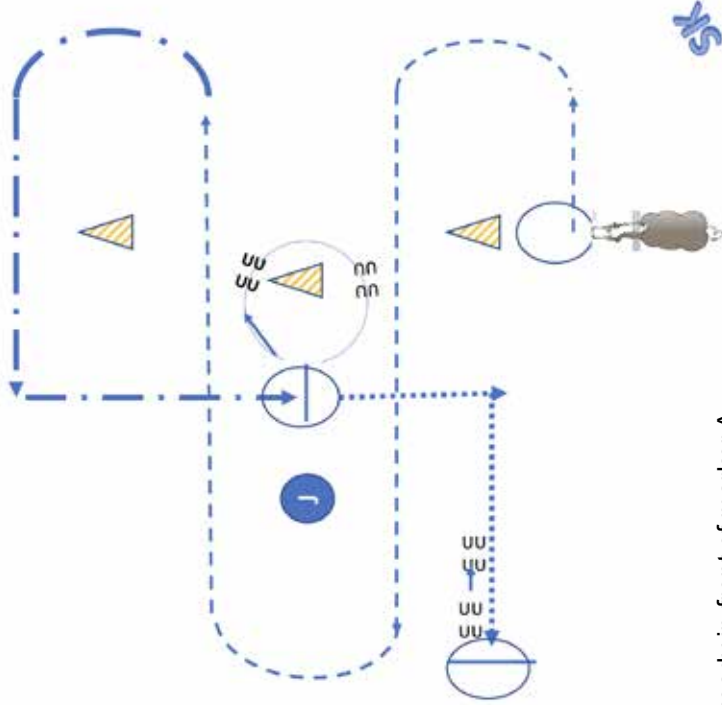

Be ready in front of marker A

1. Perform a 1 ¼ turn
 2. Trot as drawn
 3. Extended trot, show a square corner and go down the center line
 4. Stop with the horse's hip aligned with the judge
 5. Perform a 360° turn
 6. Set Up
 7. Inspection
 8. When dismissed back a circle
 9. Walk and show a square corner
 10. Perform a 360° turn
 11. Back up 2 horse lengths
- Pattern completed

6810 Showmanship VWB-Jungpferde-Cup

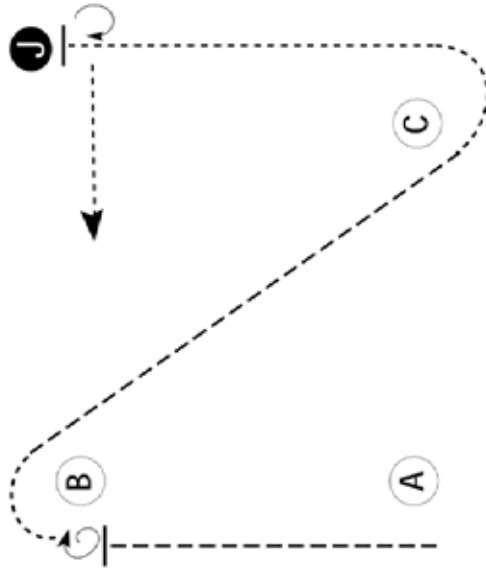

Be ready at A.

1. Trot to B.
2. Stop at B and perform a 360 degree turn.
3. Walk around B.
4. Trot from B to C.
5. Walk around C and straight to judge.
6. W/stop and set up for inspection.
7. When dismissed, perform a 270 degree turn.
Walk straight away.

NOTE: The drawn description of this pattern is only intended for the general depictions of the pattern.
Contestants should utilize the arena space to best exhibit their horses.

VWB 8127 Novice Jugend Showmanship

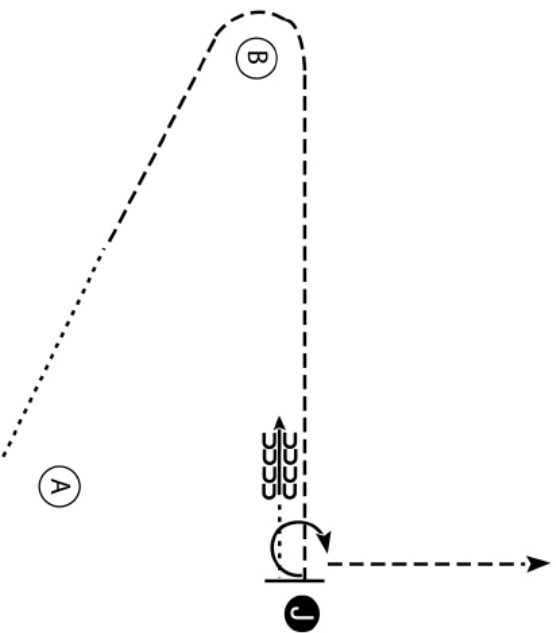

1. Walk half way from A to B.
2. Trot around B to the Judge.
3. Stop and back four steps.
4. Walk to Judge and set up for inspection.
5. When dismissed perform a 270 degree turn and trot to line-up.

NOTE: The drawn description of this pattern is only intended for the general depictions of the pattern. Contestants should utilize the arena space to best exhibit their horses.

VWB 8128 Jugend Showmanship VWB 9120 Einsteiger Showmanship

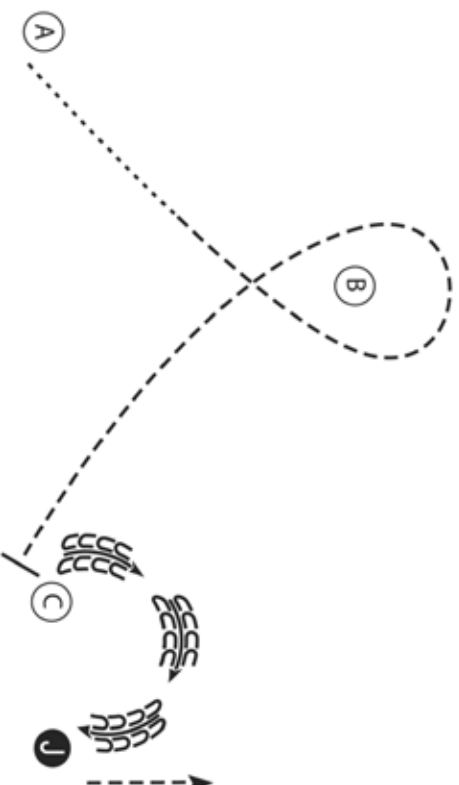

1. Walk halfway from A to B.
2. Trot to and around B and continue to C.
3. Stop at C and back in a half circle to the judge.
4. Stop and set up for inspection.
5. When dismissed trot straight away from the judge.

NOTE: The drawn description of this pattern is only intended for the general depictions of the pattern. Contestants should utilize the arena space to best exhibit their horses.

VWB 7120 Amateur Showmanship

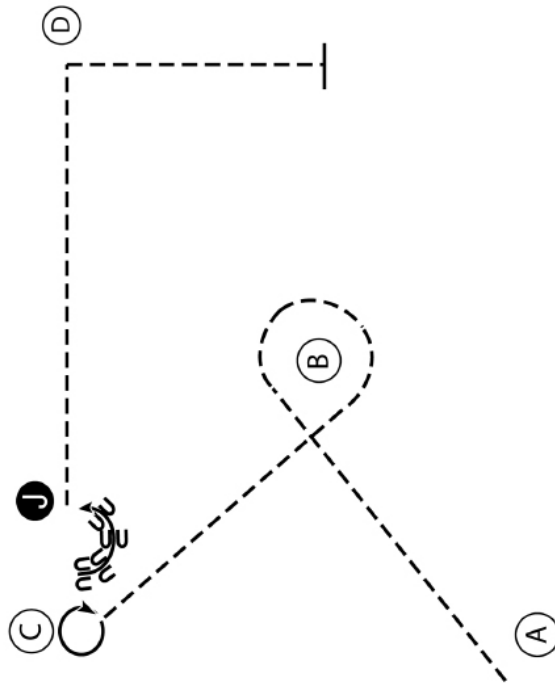

1. Trot from A to B.
2. Trot around cone B.
3. Trot to C.
4. At C stop and perform a 360 degree turn.
5. Back a half circle to the judge and set up for inspection.
6. When dismissed perform a 270 degree turn.
7. Trot to D.
8. At D make a turn to the right.
9. Trot until even with B.
10. At B stop.

NOTE: The drawn description of this pattern is only intended for the general depictions of the pattern.
Contestants should utilize the arena space to best exhibit their horses.

VWB 6120 Offen Showmanship

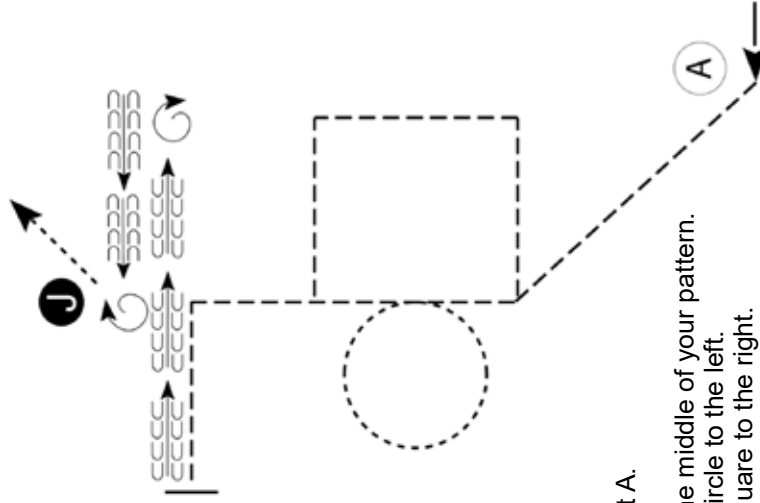

Be ready at A.

1. Trot to the middle of your pattern.
2. Walk a circle to the left.
3. Trot a square to the right.
4. Continue to trot towards the Judge.
5. Make a corner as you approach the Judge and trot at least two horse lengths past the Judge.
6. Back past the Judge.
7. Perform a 1 1/2 turn,
8. Back to the Judge.
9. Perform a 1 3/4 turn and set up for inspection
10. When dismissed, exit at a walk.

NOTE: The drawn description of this pattern is only intended for the general depictions of the pattern.
Contestants should utilize the arena space to best exhibit their horses.

AQHA 4120 Youth Showmanship
AQHA 3120 Novice Amateur Showmanship

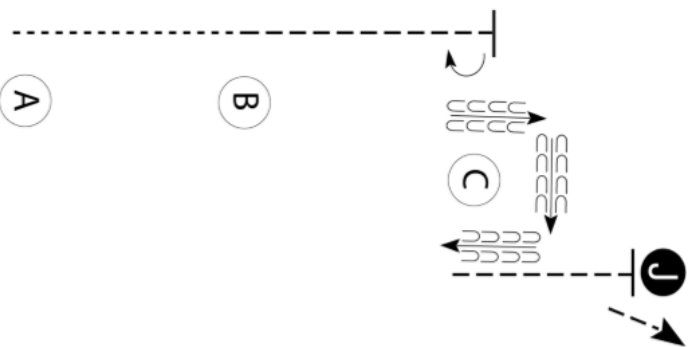

- Be ready at A.
1. Walk A to B.
 2. Trot from B until even with C.
 3. Perform a 180 degree turn.
 4. Back around C.
 5. Trot to judge.
 6. Stop and set up for inspection.
 7. When dismissed, trot away from judge.

NOTE: The drawn description of this pattern is only intended for the general depictions of the pattern. Contestants should utilize the arena space to best exhibit their horses.

AQHA 2120 Amateur Showmanship

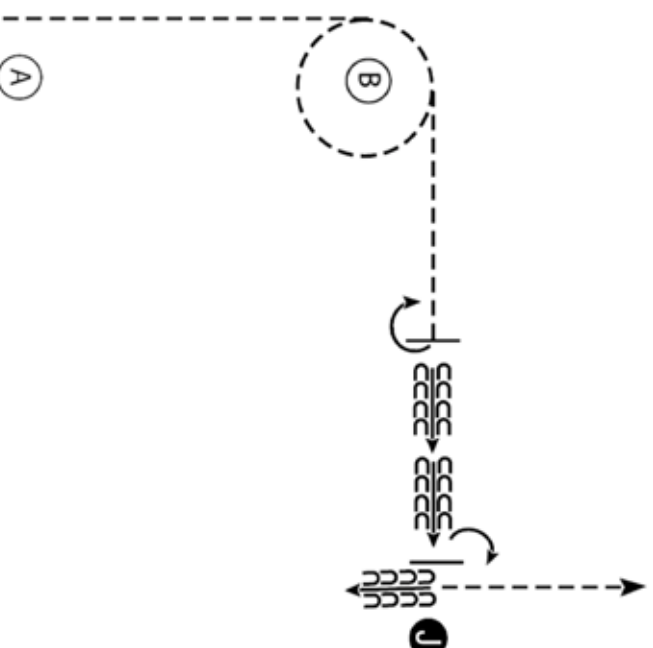

1. Trot from A to B.
2. Trot a circle around B.
3. Trot half way to the Judge. Stop and perform a 180 degree turn.
4. Back to the Judge and set up for inspection.
5. When dismissed perform a 90 degree turn.
6. Back four steps and trot straight away from the Judge.

NOTE: The drawn description of this pattern is only intended for the general depictions of the pattern. Contestants should utilize the arena space to best exhibit their horses.

VWB 8407 Novice Jugend Horsemanship

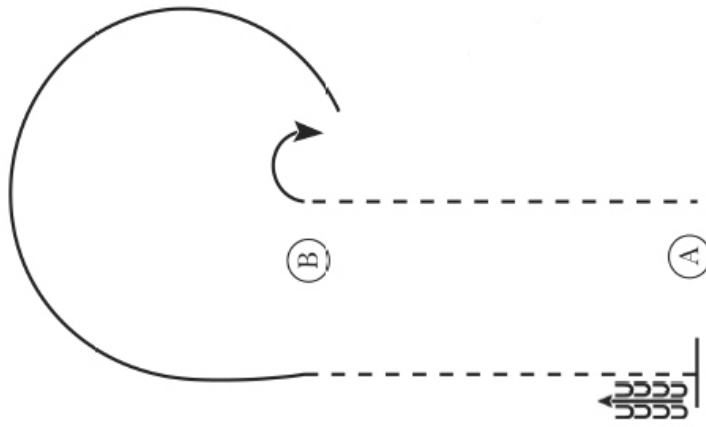

1. Jog A to B.
2. At B perform a 90 degree turn to the right.
3. Lope a circle around B on the left lead.
4. At B jog to A.
5. Stop at A and back 4 steps.

NOTE: The drawn description of this pattern is only intended for the general depictions of the pattern.
Contestants should utilize the arena space to best exhibit their horses.

VWB 8408 Jugend Horsemanship
9400 VWB Einsteiger Horsemanship

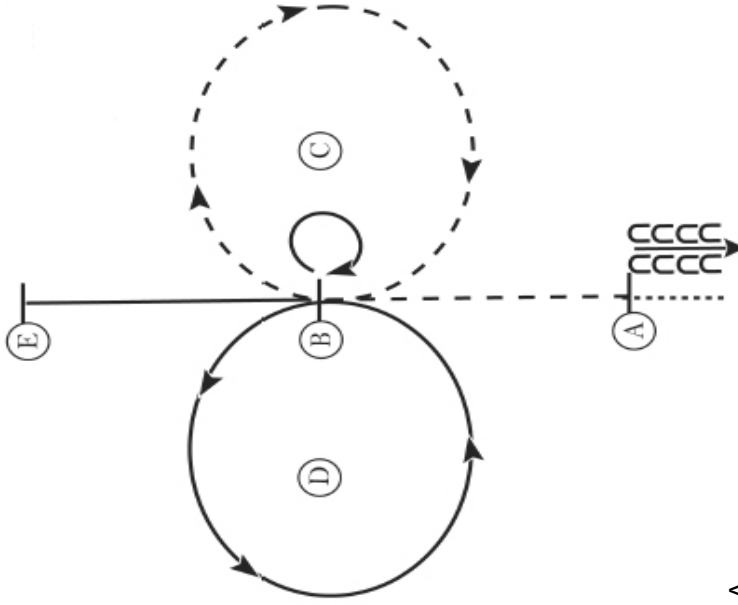

1. Walk to A.
2. At A stop and back 3 steps.
3. Jog A to B.
4. Stop at B and perform a 360 degree turn to the right.
5. Jog a circle to the right around C.
6. At B lope on the left lead, lope a circle to the left around D.
7. Continue the lope to E.
8. Stop at E.

NOTE: The drawn description of this pattern is only intended for the general depictions of the pattern.
Contestants should utilize the arena space to best exhibit their horses.

VWB 7400 Amateur Horsemanship

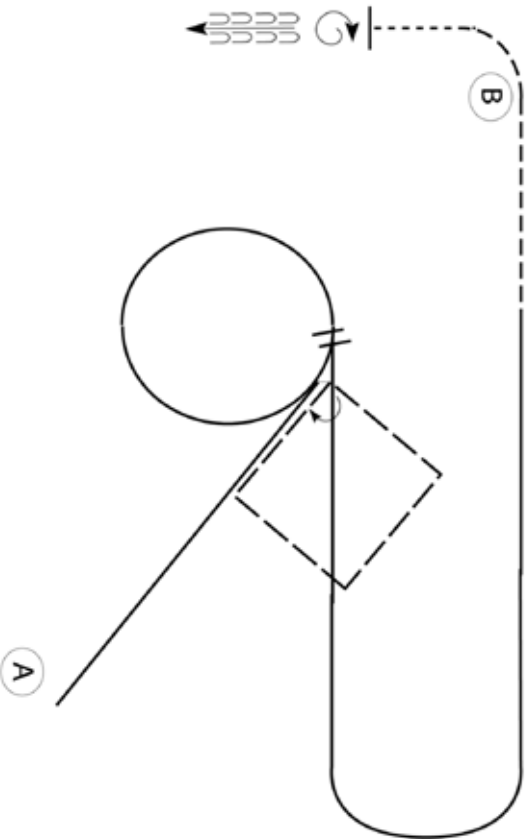

1. Lope left lead to center of pattern
2. Break to an extended jog in a square as shown.
3. Stop in center of pattern and perform a right rollback.
4. Lope a right lead circle as shown.
5. As you close circle, change leads (simple or flying).
6. Lope with a moderate increase in speed towards B as shown.
7. Break to the jog when 20 feet (6m) from B. Jog around B.
8. Break to the walk and walk one horse length.
9. Stop and perform a 540 degree turn left.
10. Back and hesitate.
11. Exit at a walk or jog.

NOTE: The drawn description of this pattern is only intended for the general depictions of the pattern. Contestants should utilize the arena space to best exhibit their horses.

AQHA 4400 Youth Horsemanship

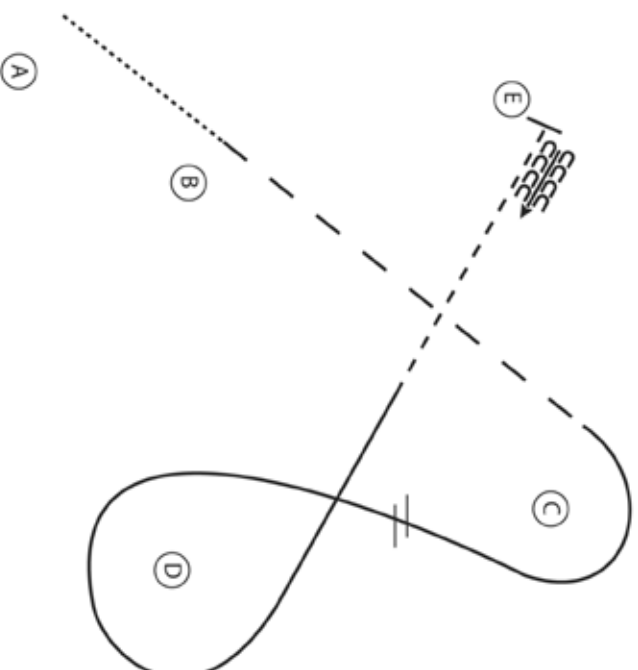

1. Walk A to B.
2. At B extend the jog to C.
3. At C lope a circle around C on the right lead.
4. Between C and D perform a lead change.
5. Lope a circle around D.
6. Break to the jog when between D and E.
7. At E stop and back 4 steps.

NOTE: The drawn description of this pattern is only intended for the general depictions of the pattern. Contestants should utilize the arena space to best exhibit their horses.

AQHA 3400 Novice Amateur Horsemanship

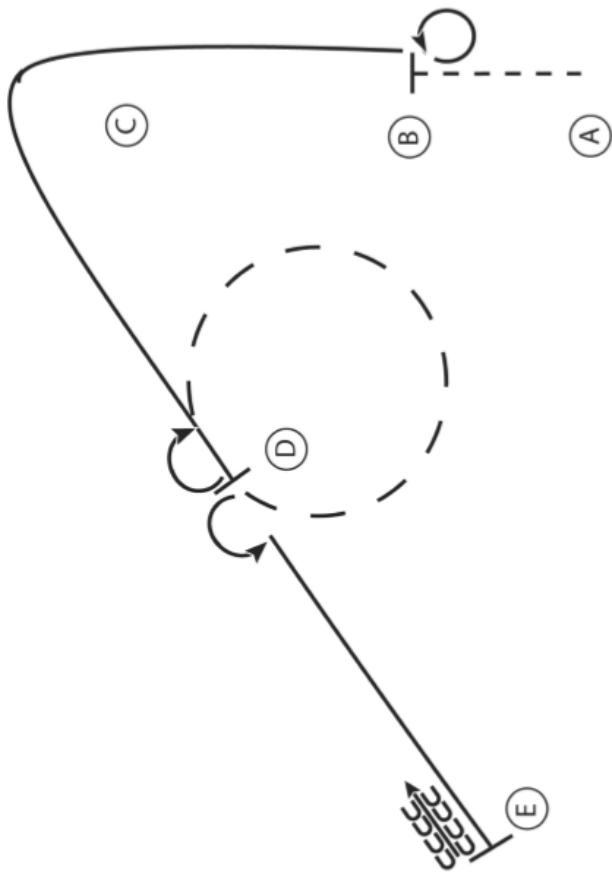

1. Jog A to B.
2. Stop at B and perform a 360 degree turn to the left.
3. Lope on the right lead around C to D.
4. Stop at D and perform a 180 degree turn to the right.
5. Extend the jog in a circle around D.
6. Stop D and perform a 180 degree turn to the left.
7. Lope on the left lead to D.
8. stop at E and back 4 steps.

NOTE: The drawn description of this pattern is only intended for the general depictions of the pattern.
Contestants should utilize the arena space to best exhibit their horses.

AQHA 2400 Amateur Horsemanship
AQHA 2408 Amateur Select Horsemanship

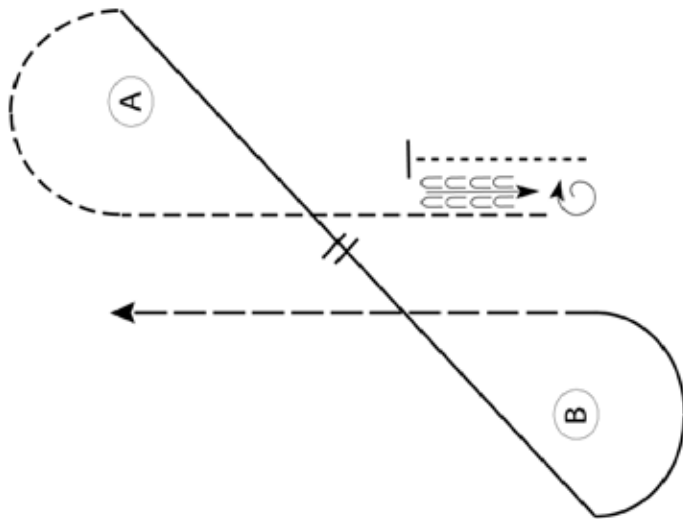

- Be ready lined up to A.
1. Walk approximately 2 horse lengths toward A.
 2. Stop and back until even with B.
 3. Perform a full turn right.
 4. Jog to and around A.
 5. Lope on the right lead halfway to B.
 6. Change leads halfway to B and lope to and around B.
 7. Extended jog in a straight line.
 8. Pattern is over once you have passed A.

NOTE: The drawn description of this pattern is only intended for the general depictions of the pattern.
Contestants should utilize the arena space to best exhibit their horses.

5054 Bavarian Golden Series Ranch Riding

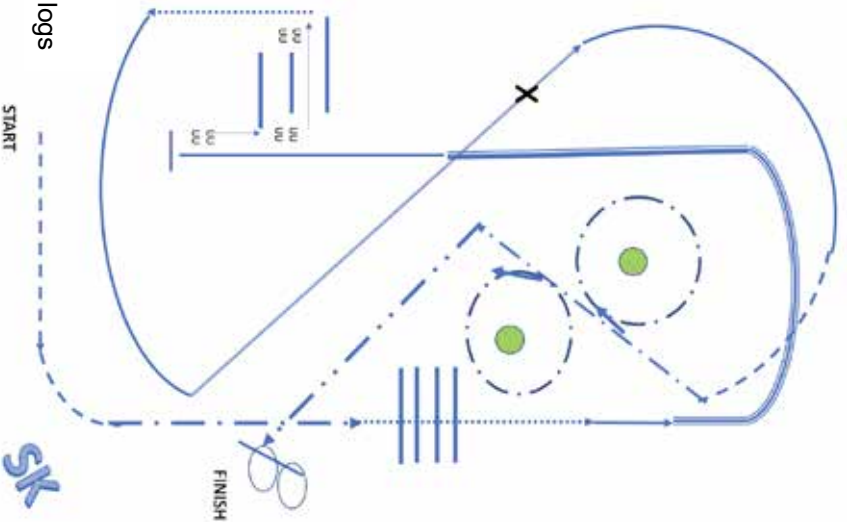

1. Trot
2. Extended trot
3. Walk and walk over logs
4. Walk
5. Lope left lead, extended lope
6. Collected lope left lead
7. Stop and back
8. Sidepass to the right and over the log
9. Walk
10. Lope left lead and lead change
11. Lope right lead
12. Trot
13. Extended trot, circle to the right, then circle to the left, square corner
14. Stop and 360° turn each way, either direction first (L-R or R-L)

5053 Bavarian Golden Series Horsemanship

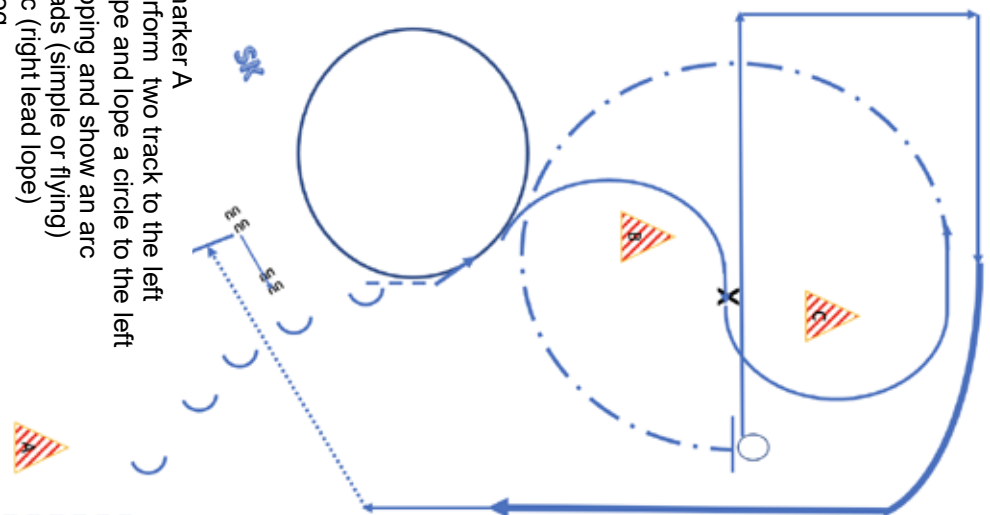

- Be ready at marker A
1. Jog and perform two tracks to the left
 2. Left lead lope and lope a circle to the left
 3. Continue loping and show an arc
 4. Change leads (simple or flying)
 5. Lope an arc (right lead lope)
 6. Extended jog
 7. Stop and perform a 1 ¼ turn to the right
 8. Lope right lead and show 2 square corners
 9. Extended lope and then show collected lope
 10. Extended walk
 11. Stop and back up 2 horse lengths

Die VWB - Bayerns größter Westernreitverein

Die Vereinigung der Westernreiter in Bayern e.V. wurde am 20.06.1982 gegründet. Heute - 40 Jahre später - ist mit über 1500 Mitgliedern aus der anfänglich kleinen Interessengemeinschaft der größte bayerische rasseoffene Westernreitverein geworden.

Es gibt viele Gründe bei uns Mitglied zu werden:

Günstige Kurse

Die VWB veranstaltet jährlich eine große Anzahl von Kursen, die von Profitrainern aus dem In- und Ausland abgehalten werden. Das Angebot umfasst sowohl Einsteiger- als auch Fortgeschrittenen-Kurse. Neben den allgemeinen Grundlagenkursen werden auch Spezialkurse für verschiedene Turnierdisziplinen angeboten.

Turniere jeder Größenordnung

Die VWB veranstaltet jährlich drei große Turniere, die mit teilweise 300-400 Pferden europaweit zu den bestbesuchten Westernturnieren zählen. Neben den großen Turnieren unterstützen wir Mitglieder, die kleinere Turniere organisieren, so dass den VWB-Mitgliedern eine breite Palette von jährlich 10-15 Turnieren zur Verfügung steht, an denen sie teilnehmen können.

Rasseoffen

In VWB-Klassen und auf VWB-Veranstaltungen kann jedes Pferd starten, wir sind offen für alle Rassen und auch für Pferde ohne Abstammungsnachweis.

Jugendarbeit

Kostengünstige Kurse und das sog. JuTu bilden die Grundlage unseres Jugendprogramms. Das JuTu ist unser Jugendturnier bei dem nur jugendliche Turniereulinge starten dürfen. Auf den großen Turnieren werden die Jugendklassen in Einsteiger (Novice Jugend) und fortgeschrittene Jugendklassen unterteilt, so dass jeder Jugendliche entsprechend seinem Leistungsniveau reiten kann. Darüber hinaus bezuschusst die VWB die Turnierboxen der Jugendlichen mit je 50 Euro pro Kat I -Turnier.

Quarter Horse Journal inklusive

Unsere Vollmitglieder erhalten monatlich neueste Informationen über das Westernreiten durch unsere Mitgliederzeitschrift ‚Quarter Horse Journal‘. Das QH-Journal beschäftigt sich neben der aktuellen Sportberichterstattung mit allen Themen rund ums Western- und Freizeitreiten, Zucht, Haltung und Lifestyle.

www.westernreiten-online.de

Darüber hinaus bietet die VWB auf ihrer Internetseite (www.westernreiten-online.de) aktuelle Informationen über Turniere, Kurse und andere News.

Weitere Infos und Anträge gibt's bei der VWB-Geschäftsstelle
Corrie Fuhr, Einzelhausen 22, 84104 Einzelhausen
Tel: 08752-2919876, e-mail: office@westernreiten-online.de



AQHA 3520 Novice Amateur Hunt Seat Equitation
 AQHA 4520 Youth Hunt Seat Equitation

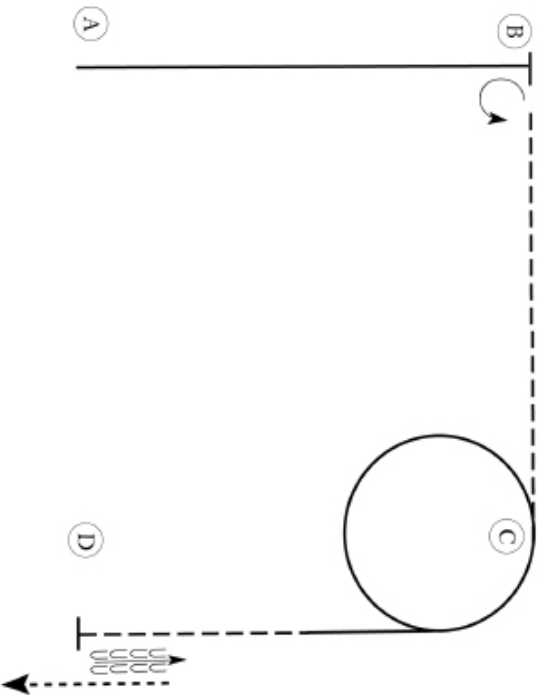

1. Canter on the left lead to B.
2. Stop at B and execute a 270 degree turn on the haunches to the left.
3. Posting trot on the right diagonal to C.
4. Canter on the right lead in a circle around C.
5. Continue on the right lead halfway to D.
6. Posting trot on the left diagonal to D.
7. Stop at D and back approximately one horse length.
8. Walk forward to and past D.

NOTE: The drawn description of this pattern is only intended for the general depictions of the pattern. Contestants should utilize the arena space to best exhibit their horses.

AQHA 2520 Amateur Hunt Seat Equitation

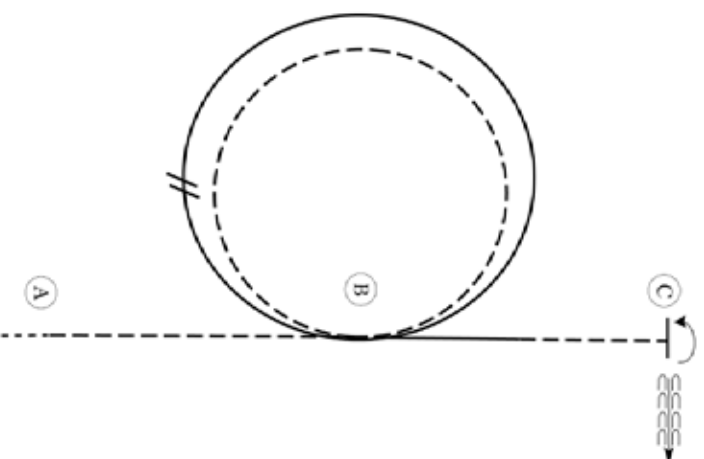

- Be ready before A.
1. Walk to A.
 2. Posting trot on the left diagonal to B.
 3. Change diagonals at B and trot a circle to the left.
 4. Canter 3/4 of a circle to the left on the left lead.
 5. When at the bottom of the circle, perform a simple lead change.
 6. Canter on the right lead to close the circle and continue on the right lead until half way to C.
 7. Sitting trot to C.
 8. Stop at C; perform a 90 degree turn to the left on the forehand.
 9. Back approximately one horse length.
- Exit at a sitting trot.

NOTE: The drawn description of this pattern is only intended for the general depictions of the pattern. Contestants should utilize the arena space to best exhibit their horses.

HAPPY BIRTHDAY

ZUM 40. LIEBE VWB

ES WAR SCHÖN GEMEINSAM MIT
EUCH SO ALT ZU WERDEN!

ZUR FEIER GIBT'S
20 PROZENT
AUF ALLES*

* vom 1. bis 7. Juni 2022
außer Sättel und bereits reduzierte Ware –
Tom Balding, BigD und 5Star 10%

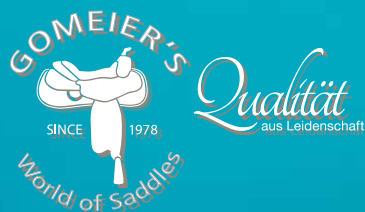

Rohr 99 in 92342 Freystadt
Telefon 0171-7535831

shop.gomeier.com

