

NOVICE YOUTH + NOVICE AMATEUR SHOWMANSHIP AT HALTER

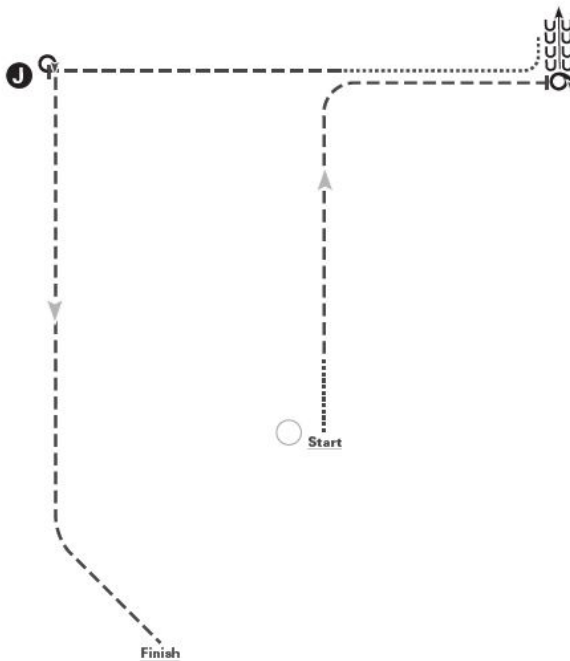

BE READY AT CONE.

1. WALK 1 HORSE LENGTH.
2. TROT CORNER TO RIGHT, STOP.
3. PERFORM A 450 DEGREE TURN.
4. BACK APPROXIMATELY 2 HORSE LENGTHS.
5. WALK CORNER 1/2 WAY, TROT TO JUDGE. STOP.
6. SET UP FOR INSPECTION.
7. INSPECTION.
8. AFTER INSPECTION, EXECUTE A 270 DEGREE TURN TO THE RIGHT.
9. TROT TO EXIT

YOUTH + AMATEUR SHOWMANSHIP AT HALTER

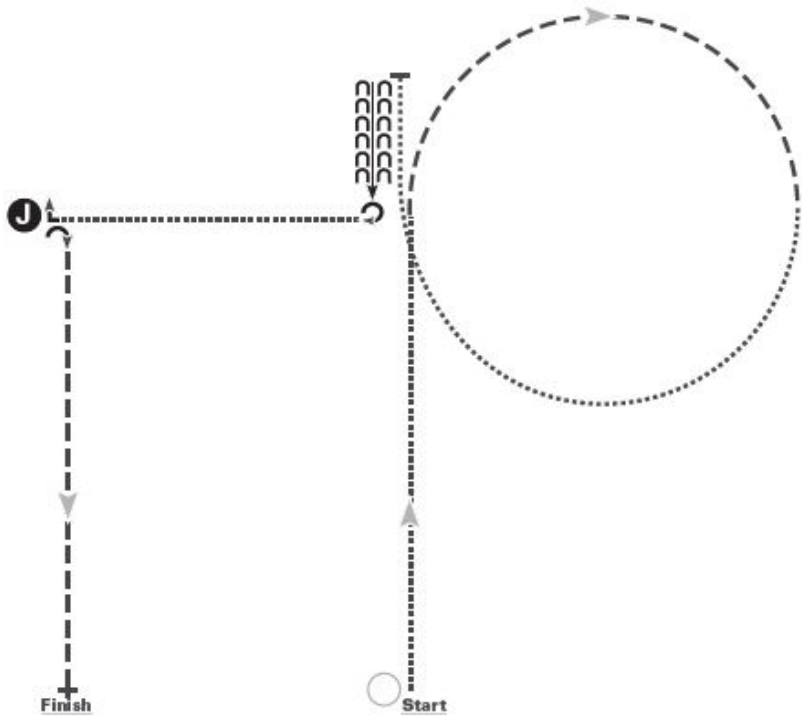

BE READY AT CONE.

1. WALK UNTIL EVEN WITH JUDGE.
2. TROT $\frac{1}{2}$ CIRCLE THEN WALK $\frac{1}{2}$ CIRCLE WALKING PAST JUDGE APPROXIMATELY 2 HORSE LENGTHS.
3. BACK HIP EVEN WITH JUDGE.
4. PERFORM A 270 DEGREE TURN.
5. WALK TO JUDGE, EXECUTE A 90 DEGREE TURN.
6. SET UP FOR INSPECTION.
7. INSPECTION.
8. AFTER INSPECTION, PERFORM A 180 DEGREE TURN.
9. TROT UNTIL EVEN WITH START CONE. STOP.

PHCG YOUTH WALK TROT SHOWMANSHIP AT HALTER

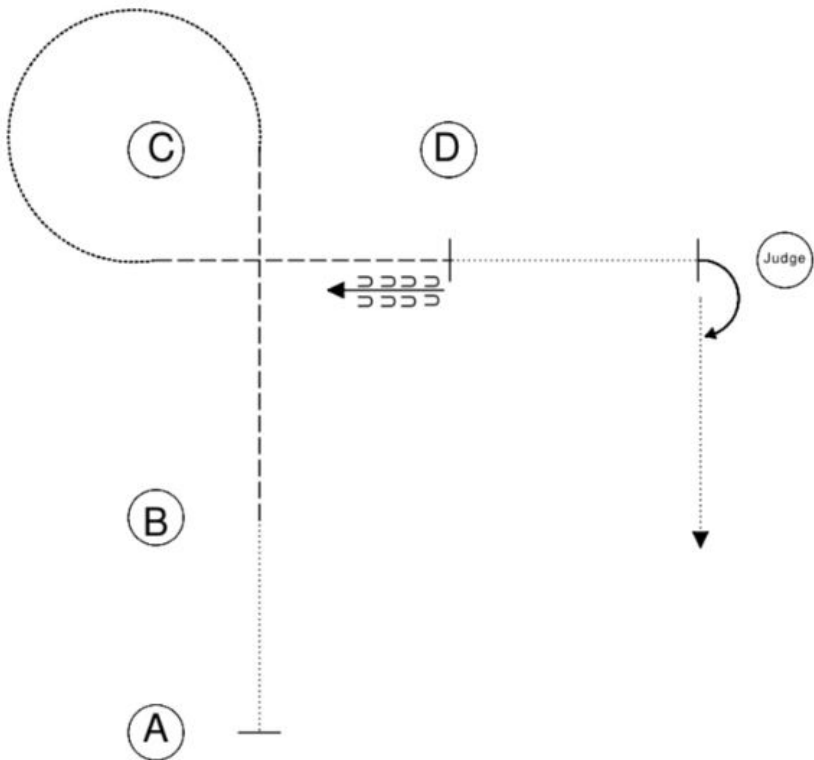

BE READY AT A.

1. WALK TO B
2. JOG TO C
3. AT C WALK 3/4 CIRCLE AROUND C
4. TROT TO D. STOP AND BACK UP APPROXIMATELY 1 HORSE LENGTH
5. WALK TO JUDGE. STOP. SET UP FOR INSPECTION. INSPECTION.
6. AFTER INSPECTION, PERFORM A 90 DEGREE TURN
7. WALK OUT AND FOLLOW THE INSTRUCTION OF YOUR RING STEWARD

YEARLING & 2-YR-OLD TRAIL IN HAND

AMATEUR YEARLING & 2-YR-OLD TRAIL IN HAND

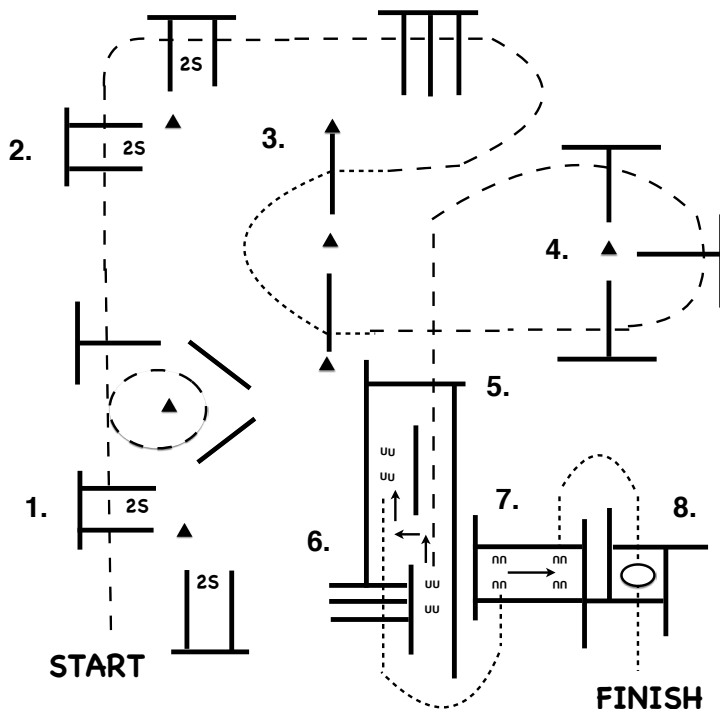

1. JOG OVER POLES, JOG AROUND CONE.
2. JOG OVER POLES.
3. STOP OR BREAK TO THE WALK, WALK THROUGH SERPENTINE, WALK OVER POLES.
4. JOG OVER POLES.
5. JOG INTO CHUTE, STOP IN CHUTE, BACK CHUTE TO CHUTE.
6. WALK OUT CHUTE, WALK OVER POLES.
7. WALK UP TO BOX, WALK OVER POLE, WALK INTO BOX AND STOP. SIDE PASS RIGHT, WALK OUT BOX, WALK OVER POLE.
8. WALK UP TO BOX, STOP OR BREAK TO THE WALK, WALK INTO BOX AND EXECUTE A 360 DEGREE TURN RIGHT, THEN WALK OUT BOX.

SENIOR TRAIL

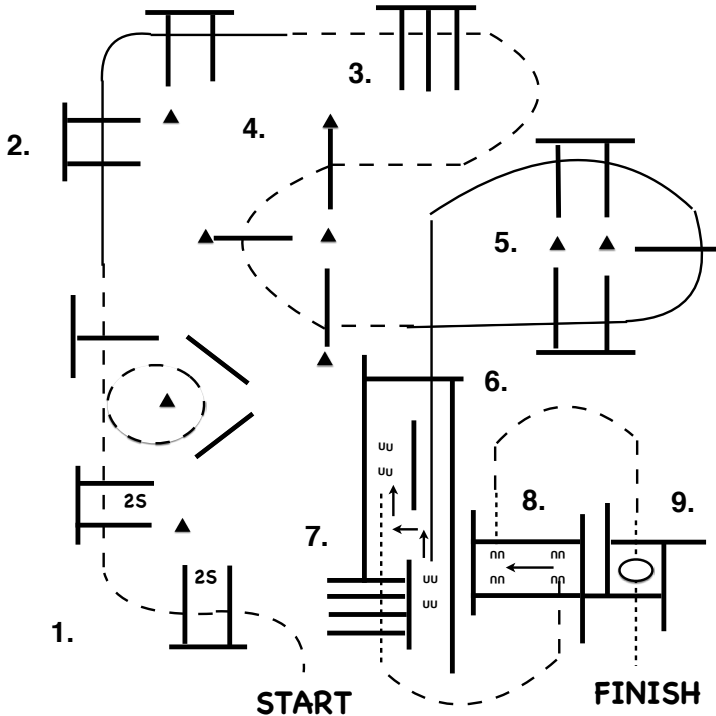

1. JOG OVER POLES, JOG AROUND CONE.
2. LOPE OVER POLES (RIGHT LEAD).
3. BREAK TO THE JOG, JOG OVER POLES.
4. JOG THROUGH SERPENTINE, JOG OVER POLES.
5. LOPE OVER POLES (LEFT LEAD).
6. LOPE INTO CHUTE (LEFT LEAD), STOP IN CHUTE, BACK CHUTE TO CHUTE.
7. WALK OUT CHUTE, WALK OVER POLES.
8. JOG OVER POLE, JOG INTO BOX AND STOP. SIDE PASS LEFT, WALK OUT BOX, WALK OVER POLE.
9. JOG UP TO BOX, STOP OR BREAK TO THE WALK, WALK INTO BOX AND EXECUTE A 360 DEGREE TURN EITHER WAY, THEN WALK OUT BOX.

JUNIOR TRAIL

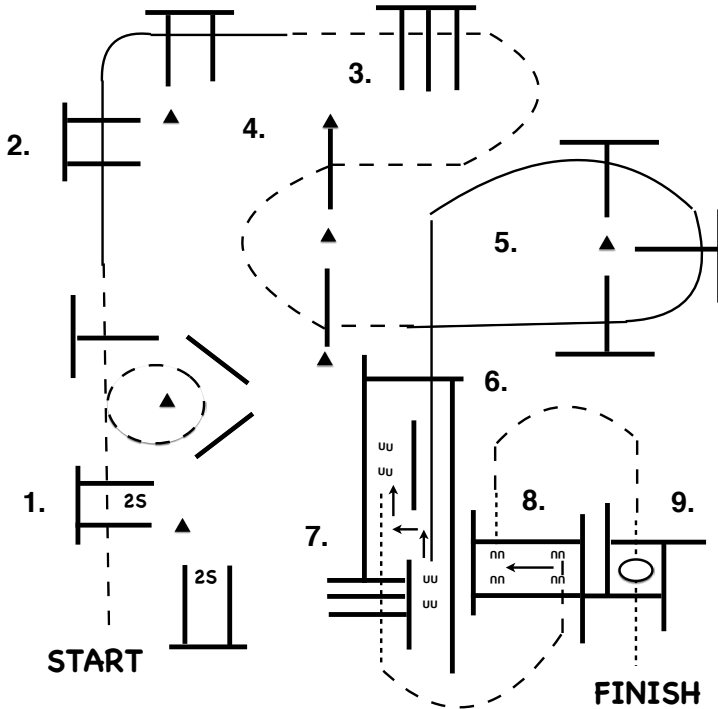

1. JOG OVER POLES, JOG AROUND CONE.
2. LOPE OVER POLES (RIGHT LEAD).
3. BREAK TO THE JOG, JOG OVER POLES.
4. JOG THROUGH SERPENTINE, JOG OVER POLES.
5. LOPE OVER POLES (LEFT LEAD).
6. LOPE INTO CHUTE (LEFT LEAD), STOP IN CHUTE, BACK CHUTE TO CHUTE.
7. WALK OUT CHUTE, WALK OVER POLES.
8. JOG OVER POLE, JOG INTO BOX AND STOP. SIDE PASS LEFT, WALK OUT BOX, WALK OVER POLE.
9. JOG UP TO BOX, STOP OR BREAK TO THE WALK, WALK INTO BOX AND EXECUTE A 360 DEGREE TURN EITHER WAY, THEN WALK OUT BOX.

NOVICE YOUTH + NOVICE AMATEUR + GREEN TRAIL

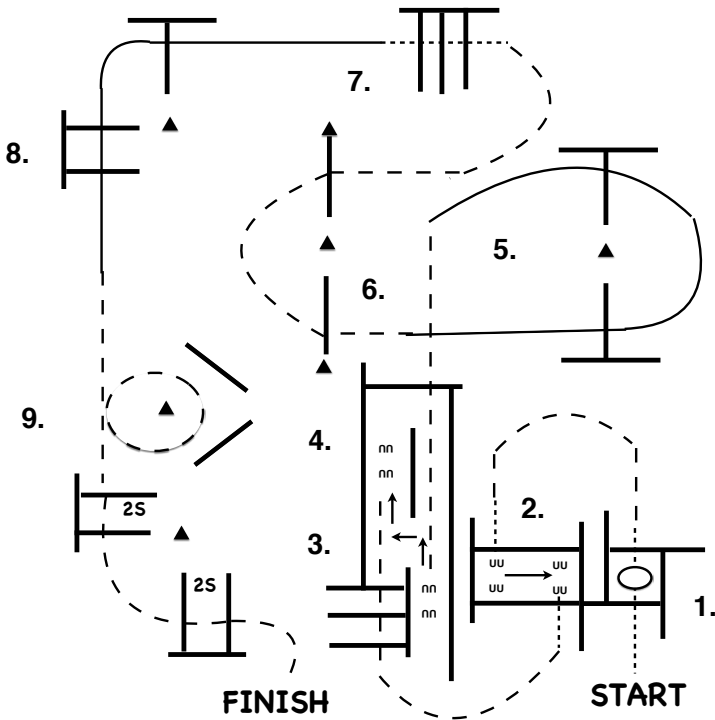

1. WALK INTO BOX, EXECUTE A 360 DEGREE TURN EITHER WAY, THEN WALK OVER POLE AND WALK OUT THE BOX.
2. JOG UP TO SECOND BOX, STOP OR BREAK TO THE WALK, WALK INTO BOX, SIDE PASS LEFT, WALK OVER POLE, WALK OUT BOX.
3. JOG OVER POLES, JOG INTO CHUTE, STOP IN CHUTE.
4. BACK CHUTE TO CHUTE, JOG OUT CHUTE, JOG OVER POLE.
5. LOPE OVER POLES (RIGHT LEAD).
6. BREAK TO THE JOG, JOG THROUGH SERPENTINE, JOG OVER POLES.
7. STOP OR BREAK TO THE WALK, WALK OVER POLES.
8. LOPE OVER POLES (LEFT LEAD).
9. BREAK TO THE JOG, JOG AROUND CONE TO THE LEFT, AND THEN JOG OVER MORE POLES.

YOUTH + AMATEUR TRAIL

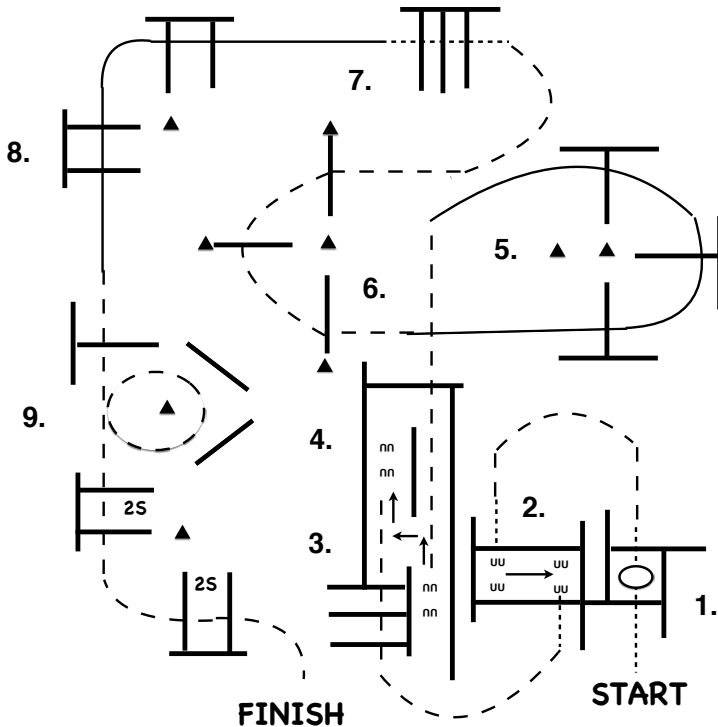

1. WALK INTO BOX, EXECUTE A 360 DEGREE TURN EITHER WAY, THEN WALK OVER POLE AND WALK OUT THE BOX.
2. JOG UP TO SECOND BOX, STOP OR BREAK TO THE WALK, WALK INTO BOX, SIDE PASS LEFT, WALK OVER POLE, WALK OUT BOX.
3. JOG OVER POLES, JOG INTO CHUTE, STOP IN CHUTE.
4. BACK CHUTE TO CHUTE, JOG OUT CHUTE, JOG OVER POLE.
5. LOPE OVER POLES (RIGHT LEAD).
6. BREAK TO THE JOG, JOG THROUGH SERPENTINE, JOG OVER POLES.
7. STOP OR BREAK TO THE WALK, WALK OVER POLES.
8. LOPE OVER POLES (LEFT LEAD).
9. BREAK TO THE JOG, JOG OVER POLES, JOG AROUND CONE TO THE LEFT, AND JOG OVER MORE POLES.

NOVICE YOUTH + NOVICE AMATEUR WESTERN HORSEMANSHIP

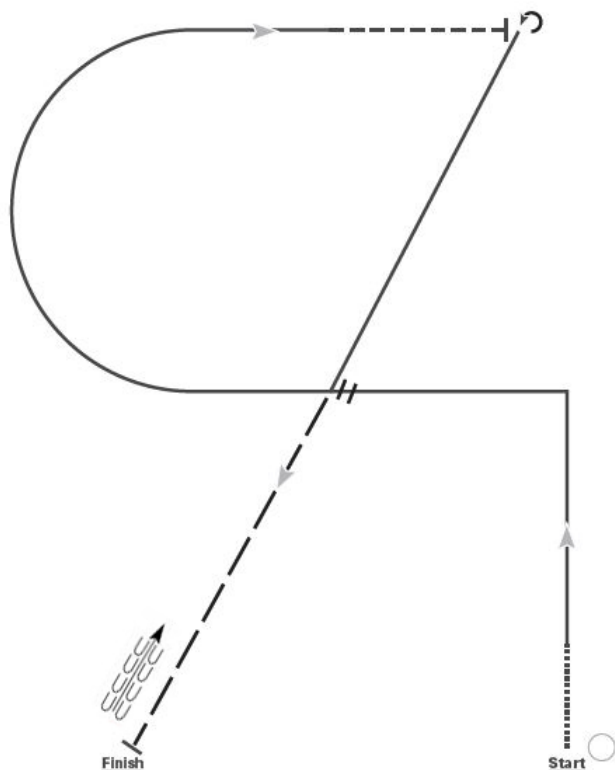

BE READY AT CONE.

1. WALK 2 HORSE LENGTHS.
2. LOPE LEFT LEAD, MAKE A SQUARE CORNER AT THE MIDDLE OF THE ARENA.
3. SIMPLE LEAD CHANGE AT THE CENTER OF THE ARENA.
4. RIGHT LEAD $\frac{1}{2}$ CIRCLE.
5. BREAK TO JOG, STOP.
6. PERFORM A 225 DEGREE TURN TO THE LEFT.
7. LOPE LEFT LEAD TO CENTER.
8. BREAK TO EXTENDED JOG.
STOP EVEN WITH CONE AND BACK UP ONE HORSE LENGTH

YOUTH + AMATEUR + AMATEUR SPB WESTERN HORSEMANSHIP

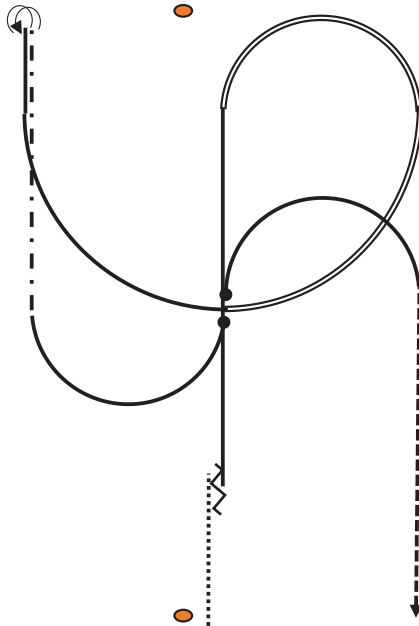

BE READY AT MARKER

1. WALK STRAIGHT LINE $\frac{1}{2}$ WAY TO CENTER OF THE ARENA
 2. STOP, BACK UP 4 STEPS
 3. LOPE STRAIGHT RIGHT LEAD, EXTEND LOPE ON A CIRCLE TO THE CENTER OF THE ARENA
 4. REGULAR LOPE ON $\frac{1}{4}$ CIRCLE
 5. STOP WHEN EVEN WITH MARKER, TURN $1 \frac{1}{2}$ LEFT
 6. EXTENDED JOG ON A STRAIGHT LINE UNTIL EVEN WITH CENTER
 7. LOPE LEFT LEAD $\frac{1}{2}$ CIRCLE, CHANGE LEADS (SIMPLE OR FLYING)
 8. LOPE RIGHT LEAD $\frac{1}{2}$ CIRCLE
 9. WHEN EVEN WITH CENTER JOG STRAIGHT LINE TO THE END OF THE ARENA
- EXIT AT JOG

PHCG YOUTH WALK TROT WESTERN HORSEMANSHIP

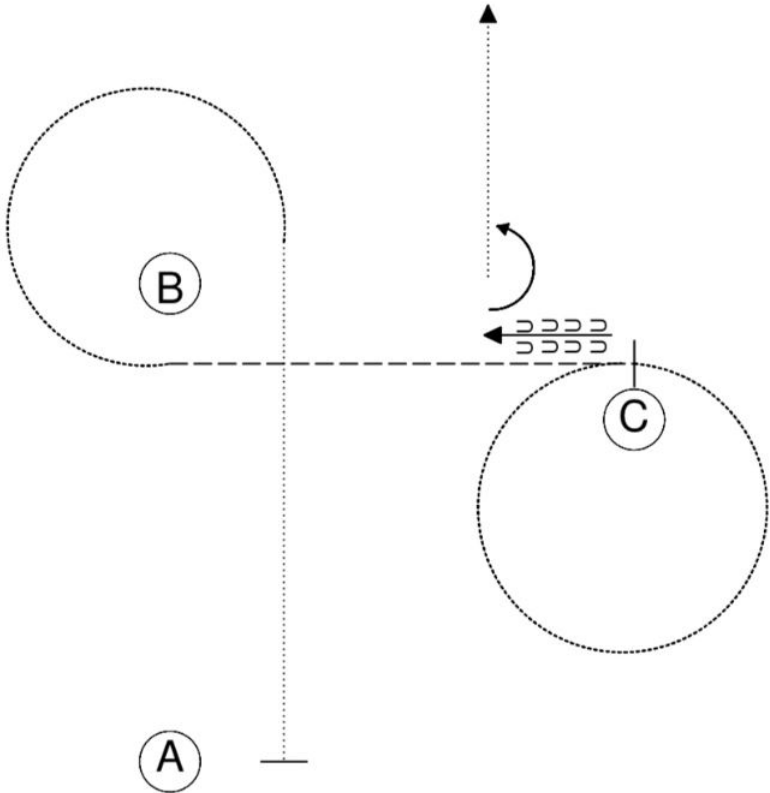

BE READY AT A

1. WALK TO B
2. AT B WALK 3/4 CIRCLE AROUND B
3. TROT TO C. WALK CIRCLE AROUND C
4. STOP AT C AND BACK UP APPROXIMATELY 1 HORSE LENGTH
5. PERFORM A 90 DEGREE TURN TO THE LEFT
6. WALK OUT AND FOLLOW THE INSTRUCTION OF YOUR RING STEWARD

GREEN WESTERN RIDING

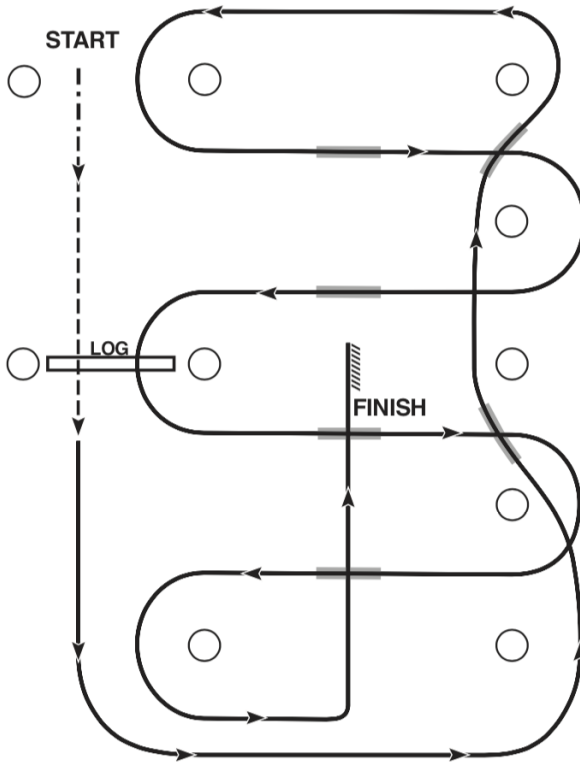

Pattern 1

1. WALK AT LEAST 15 FEET FROM START CONE TO THE FIRST MARKER, AS DRAWN, TRANSITION TO JOG, JOG OVER LOG.
2. TRANSITION TO LEFT LEAD AND LOPE AROUND END.
3. FIRST LINE CHANGE.
4. SECOND LINE CHANGE LOG AROUND END OF ARENA.
5. FIRST CROSSING CHANGE.
6. SECOND CROSSING CHANGE.
7. LOPE OVER LOG.
8. THIRD CROSSING CHANGE.
9. FOURTH CROSSING CHANGE.
10. LOPE UP THE CENTER, STOP AND BACK

AMATEUR & OPEN & YOUTH WESTERN RIDING

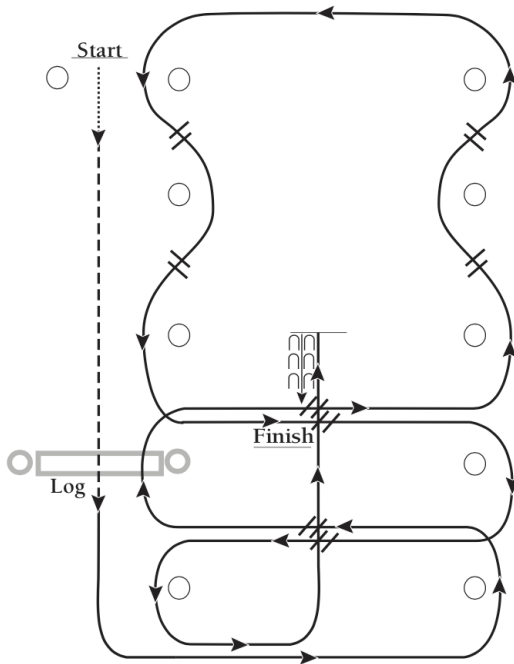

Pattern 3

1. WALK AT LEAST 15 FEET FROM START CONE TO THE FIRST MARKER, AS DRAWN, TRANSITION TO JOG, JOG OVER LOG
2. TRANSITION TO LOPE, LOPE TO LEFT AROUND END.
3. FIRST CROSSING CHANGE.
4. LOPE OVER LOG.
5. SECOND CROSSING CHANGE.
6. FIRST LINE CHANGE.
7. SECOND LINE CHANGE.
8. THIRD LINE CHANGE.
9. FOURTH LINE CHANGE.
10. THIRD CROSSING CHANGE.
11. FOURTH CROSSING CHANGE.
12. LOPE UP THE CENTER, STOP AND BACK.

NOVICE YOUTH & NOVICE AMATEUR HUNT SEAT EQUITATION

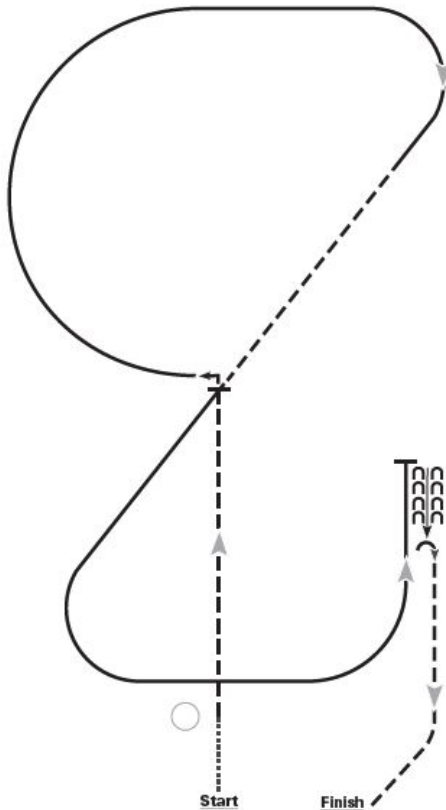

1. WALK TO CONE.
2. TROT RIGHT DIAGONAL.
3. AT CENTER OF ARENA, STOP AND PERFORM A 90 DEGREE LEFT FOREHAND TURN.
4. CANTER RIGHT LEAD.
5. BREAK INTO POSTING TROT. LEFT DIAGONAL TO CENTER.
6. CANTER LEFT LEAD.
7. STOP, BACK.
8. 180 DEGREE TURN TO THE RIGHT ON THE HAUNCHES.
9. SITTING TROT TO EXIT.

YOUTH & AMATEUR HUNT SEAT EQUITATION

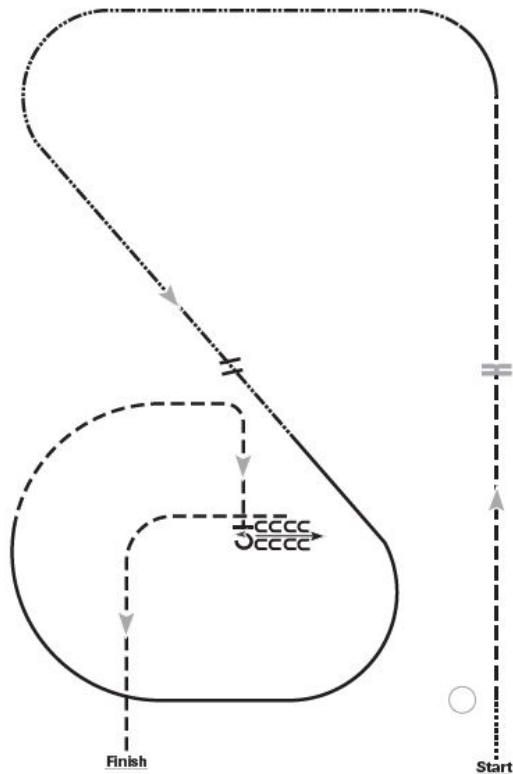

1. WALK TO CONE.
2. SITTING TROT TO MIDDLE OF ARENA.
3. POSTING TROT LEFT DIAGONAL.
4. CANTER LEFT LEAD MOVING INTO HAND GALLOP.
5. CHANGE LEADS (SIMPLE OR FLYING) AT CENTER.
6. COLLECT CANTER ROUND TO RIGHT.
7. BREAK TO LEFT DIAGONAL, MAKING A RIGHT CORNER AT CENTER.
8. STOP, 270 DEGREE TURN TO THE LEFT ON THE FOREHAND. BACK.
9. POSTING TROT ON THE RIGHT DIAGONAL TO EXIT.

NOVICE YOUTH & NOVICE AMATEUR & OPEN RANCH RIDING

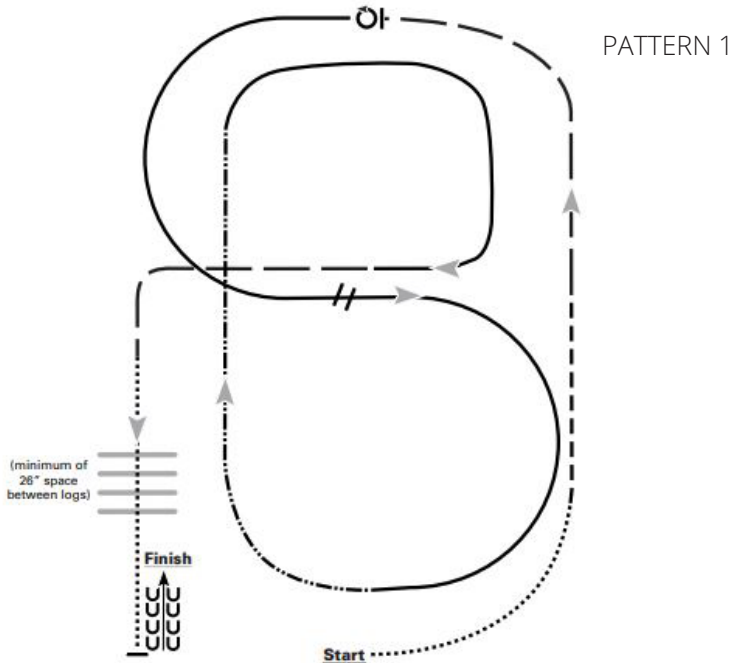

1. WALK
2. TROT
3. EXTEND THE TROT ,AT THE TOP OF THE ARENA, STOP
4. 360 TURN TO THE LEFT
5. LEFT LEAD ½ CIRCLE, LOPE TO THE CENTER
6. CHANGE LEADS (SIMPLE OR FLYING)
7. RIGHT LEAD ½ CIRCLE
8. EXTENDED LOPE UP THE LONG SIDE OF THE ARENA (RIGHT LEAD)
9. COLLECT BACK TO A LOPE AROUND THE TOP OF THE ARENA AND BACK TO CENTER
10. BREAK DOWN TO AN EXTENDED TROT
11. WALK OVER POLES
12. STOP AND BACK

YOUTH & AMATEUR RANCH RIDING

PATTERN 3

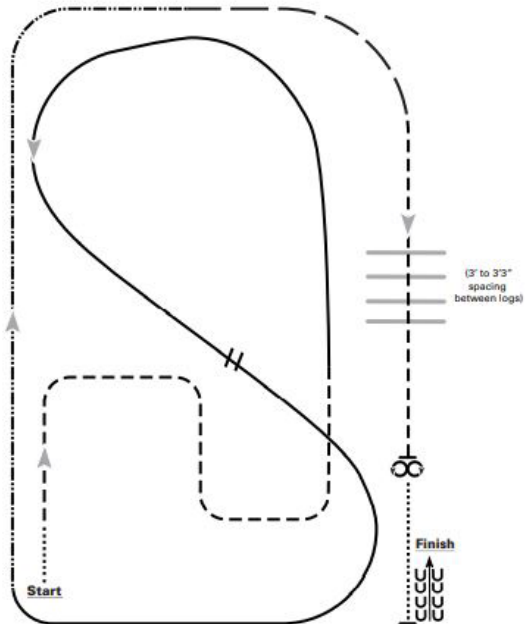

1. WALK
2. TROT SERPENTINE
3. LOPE LEFT LEAD AROUND THE END OF THE ARENA AND THEN DIAGONALLY ACROSS THE ARENA
4. CHANGE LEADS (SIMPLE OR FLYING) AND
5. LOPE ON THE RIGHT LEAD AROUND END OF THE ARENA
6. EXTEND LOPE ON THE STRAIGHT AWAY AND AROUND CORNER TO THE CENTER OF THE ARENA
7. EXTEND TROT AROUND CORNER OF THE ARENA
8. COLLECT TO A TROT
9. TROT OVER POLES
10. STOP, DO 360 TURN EACH DIRECTION (EITHER DIRECTION 1ST)
(L-R OR R-L)
11. WALK, STOP AND BACK

YOUTH & OPEN HUNTER HACK

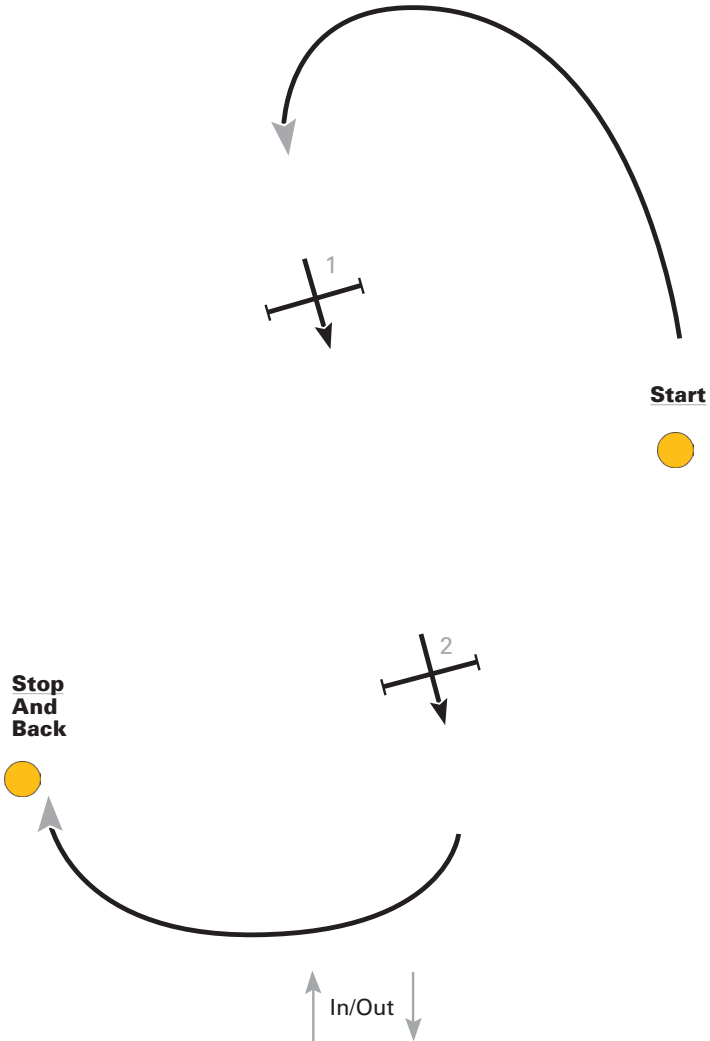

NOVICE AMATEUR REINING

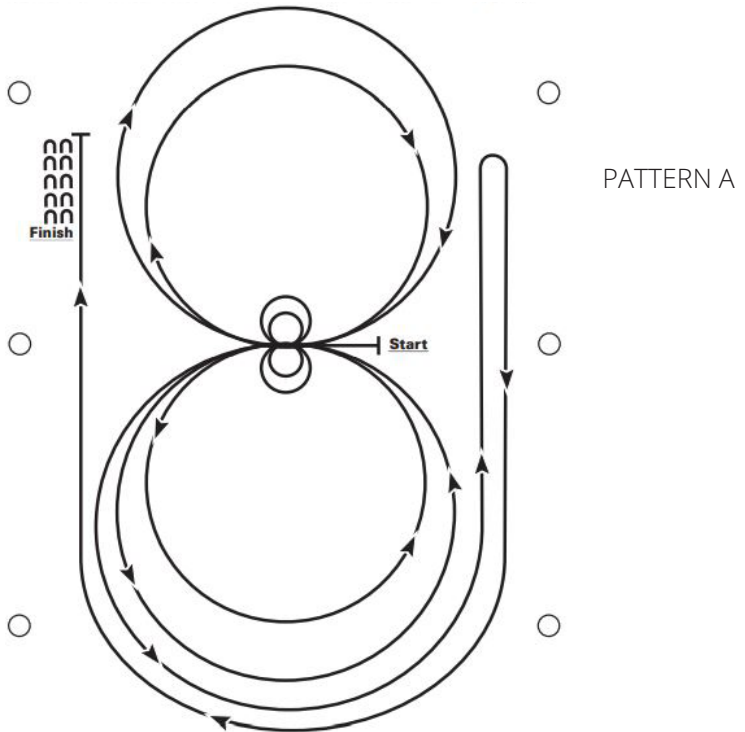

HORSES MAY WALK OR JOG TO THE CENTER OF THE ARENA. HORSES MUST WALK OR STOP PRIOR TO STARTING THE PATTERN. BEGINNING AT THE CENTER OF THE ARENA FACING THE LEFT WALL OR FENCE.

1. BEGINNING ON THE LEFT LEAD, COMPLETE TWO CIRCLES TO THE LEFT. STOP AT THE CENTER OF THE ARENA. HESITATE.
2. COMPLETE TWO SPINS TO THE LEFT. HESITATE.
3. BEGINNING ON THE RIGHT LEAD COMPLETE TWO CIRCLES TO THE RIGHT. STOP AT THE CENTER OF THE ARENA. HESITATE.
4. COMPLETE TWO SPINS TO THE RIGHT. HESITATE.
5. BEGINNING ON THE LEFT LEAD, GO AROUND THE END OF THE ARENA, RUN DOWN THE RIGHT SIDE OF THE ARENA PAST CENTER MARKER, STOP AND ROLL BACK RIGHT.
6. CONTINUE AROUND THE END OF THE ARENA TO RUN DOWN THE LEFT SIDE OF THE ARENA PAST THE CENTER MARKER. STOP. BACK UP. HESITATE TO DEMONSTRATE COMPLETION OF THE PATTERN.

YOUTH & AMATEUR & OPEN JUNIOR & GREEN

REINING

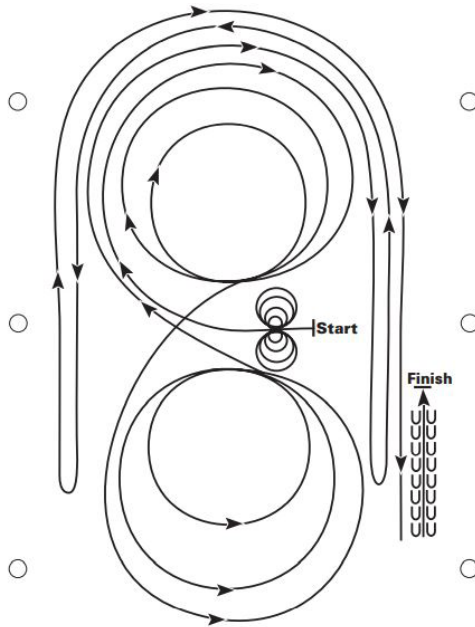

PATTERN 8

HORSES MAY WALK OR JOG TO THE CENTER OF THE ARENA. HORSES MUST WALK OR STOP PRIOR TO STARTING PATTERN. BEGINNING AT THE CENTER OF THE ARENA FACING THE LEFT WALL OR FENCE.

1. COMPLETE FOUR SPINS TO THE LEFT. HESITATE.
2. COMPLETE FOUR SPINS TO THE RIGHT. HESITATE.
3. BEGINNING ON THE RIGHT LEAD, COMPLETE THREE CIRCLES TO THE RIGHT: THE FIRST CIRCLE LARGE AND FAST; THE SECOND CIRCLE SMALL AND SLOW; THE THIRD CIRCLE LARGE AND FAST. CHANGE LEADS AT THE CENTER OF THE ARENA.
4. COMPLETE THREE CIRCLES TO THE LEFT: THE FIRST CIRCLE LARGE AND FAST; THE SECOND CIRCLE SMALL AND SLOW; THE THIRD CIRCLE LARGE AND FAST. CHANGE LEADS AT THE CENTER OF THE ARENA.
5. BEGIN A LARGE CIRCLE TO THE RIGHT BUT DO NOT CLOSE THIS CIRCLE. RUN STRAIGHT DOWN THE RIGHT SIDE OF THE ARENA PAST THE CENTER MARKER AND DO A LEFT ROLL BACK AT LEAST TWENTY FEET (6.09M) FROM THE WALL OR FENCE - NO HESITATION.
6. CONTINUE BACK AROUND THE PREVIOUS CIRCLE BUT DO NOT CLOSE THIS CIRCLE. RUN DOWN THE LEFT SIDE OF THE ARENA PAST THE CENTER MARKER AND DO A RIGHT ROLL BACK AT LEAST TWENTY FEET (6.09M) FROM THE WALL OR FENCE - NO HESITATION.
7. CONTINUE BACK AROUND THE PREVIOUS CIRCLE BUT DO NOT CLOSE THIS CIRCLE. RUN DOWN THE RIGHT SIDE OF THE ARENA PAST THE CENTER MARKER AND DO A SLIDING STOP AT LEAST TWENTY FEET (6.09M) FROM THE WALL OR FENCE. BACK UP AT LEAST TEN FEET (3M). HESITATE TO DEMONSTRATE COMPLETION OF THE PATTERN.

RIDER MAY DISMOUNT AND DROP BRIDLE TO THE DESIGNATED JUDGE

OPEN SENIOR REINING

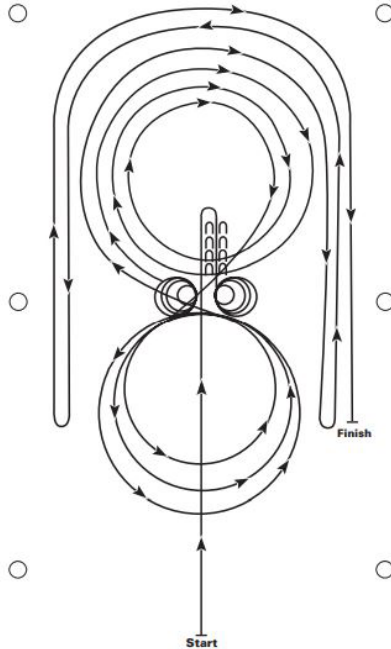

PATTERN 10

1. RUN PAST THE CENTER MARKER AND DO A SLIDING STOP. BACK UP TO THE CENTER OF THE ARENA OR AT LEAST TEN FEET (3M). HESITATE.
2. COMPLETE FOUR SPINS TO THE RIGHT. HESITATE.
3. COMPLETE FOUR AND ONE-QUARTER SPINS TO THE LEFT SO THAT THE HORSE IS FACING THE LEFT WALL OR FENCE. HESITATE.
4. BEGINNING ON THE RIGHT LEAD, COMPLETE THREE CIRCLES TO THE RIGHT: THE FIRST TWO CIRCLES LARGE AND FAST, THE THIRD CIRCLE SMALL AND SLOW. CHANGE LEADS AT THE CENTER OF THE ARENA.
5. COMPLETE THREE CIRCLES TO THE LEFT: THE FIRST CIRCLE SMALL AND SLOW, THE NEXT TWO CIRCLES LARGE AND FAST. CHANGE LEADS AT THE CENTER OF THE ARENA.
6. BEGIN A LARGE CIRCLE TO THE RIGHT BUT DO NOT CLOSE THIS CIRCLE. RUN DOWN THE RIGHT SIDE OF THE ARENA PAST THE CENTER MARKER AND DO A LEFT ROLLBACK AT LEAST TWENTY FEET (6.09M) FROM THE WALL OR FENCE – NO HESITATION.
7. CONTINUE BACK AROUND THE PREVIOUS CIRCLE BUT DO NOT CLOSE THIS CIRCLE. RUN DOWN THE LEFT SIDE OF THE ARENA PAST THE CENTER AND DO A RIGHT ROLLBACK AT LEAST TWENTY FEET (6.09M) FROM THE WALL OR FENCE – NO HESITATION.
8. CONTINUE BACK AROUND PREVIOUS CIRCLE BUT DO NOT CLOSE THIS CIRCLE. RUN DOWN THE RIGHT SIDE OF THE ARENA PAST THE CENTER MARKER AND DO A SLIDING STOP AT LEAST TWENTY FEET (6.09M) FROM THE WALL OR FENCE. HESITATE TO DEMONSTRATE COMPLETION OF PATTERN.

RIDER MAY DISMOUNT AND DROP BRIDLE TO THE DESIGNATED JUDGE.